

TOPOLOGY WITHOUT TEARS¹

SIDNEY A. MORRIS²



Version of October 14, 2007³

¹©Copyright 1985-2007. No part of this book may be reproduced by any process without prior written permission from the author. If you would like a printable version of this book please e-mail your name, address, and commitment to respect the copyright (by not providing the password, hard copy or soft copy to anyone else) to s.morris@ballarat.edu.au

²A version of this book translated into Persian is expected to be available soon.

³This book is being progressively updated and expanded; it is anticipated that there will be about fifteen chapters in all. If you discover any errors or you have suggested improvements please e-mail: s.morris@ballarat.edu.au

Contents

0	Introduction	5
0.1	Acknowledgment	7
0.2	Readers – Locations and Professions	7
0.3	Readers’ Compliments	8
1	Topological Spaces	13
1.1	Topology	14
1.2	Open Sets	21
1.3	Finite-Closed Topology	26
1.4	Postscript	33
2	The Euclidean Topology	35
2.1	Euclidean Topology	36
2.2	Basis for a Topology	41
2.3	Basis for a Given Topology	48
2.4	Postscript	55
3	Limit Points	56
3.1	Limit Points and Closure	57
3.2	Neighbourhoods	62
3.3	Connectedness	66
3.4	Postscript	69
4	Homeomorphisms	70
4.1	Subspaces	70
4.2	Homeomorphisms	75
4.3	Non-Homeomorphic Spaces	81
4.4	Postscript	89
5	Continuous Mappings	90

5.1	Continuous Mappings	90
5.2	Intermediate Value Theorem	97
5.3	Postscript	103
6	Metric Spaces	104
6.1	Metric Spaces	104
6.2	Convergence of Sequences	121
6.3	Completeness	125
6.4	Contraction Mappings	136
6.5	Baire Spaces	140
6.6	Postscript	147
7	Compactness	149
7.1	Compact Spaces	150
7.2	The Heine-Borel Theorem	154
7.3	Postscript	161
8	Finite Products	162
8.1	The Product Topology	163
8.2	Projections onto Factors of a Product	167
8.3	Tychonoff's Theorem for Finite Products	172
8.4	Products and Connectedness	175
8.5	Fundamental Theorem of Algebra	178
8.6	Postscript	181
9	Countable Products	182
9.1	The Cantor Set	183
9.2	The Product Topology	185
9.3	The Cantor Space and the Hilbert Cube	189
9.4	Urysohn's Theorem	196
9.5	Peano's Theorem	205
9.6	Postscript	212
10	Tychonoff's Theorem	213
10.1	The Product Topology For All Products	214
10.2	Zorn's Lemma	218
10.3	Tychonoff's Theorem	224
10.4	Stone-Čech Compactification	239
10.5	Postscript	246

Appendix 1: Infinite Sets	247
Appendix 2: Topology Personalities	270
Appendix 3: Chaos Theory and Dynamical Systems	277
Appendix 4: Hausdorff Dimension	306
Appendix 5: Topological Groups	319
Bibliography	343
Index	359

Chapter 0

Introduction

Topology is an important and interesting area of mathematics, the study of which will not only introduce you to new concepts and theorems but also put into context old ones like continuous functions. However, to say just this is to understate the significance of topology. It is so fundamental that its influence is evident in almost every other branch of mathematics. This makes the study of topology relevant to all who aspire to be mathematicians whether their first love is (or will be) algebra, analysis, category theory, chaos, continuum mechanics, dynamics, geometry, industrial mathematics, mathematical biology, mathematical economics, mathematical finance, mathematical modelling, mathematical physics, mathematics of communication, number theory, numerical mathematics, operations research or statistics. (The substantial bibliography at the end of this book suffices to indicate that topology does indeed have relevance to all these areas, and more.) Topological notions like compactness, connectedness and denseness are as basic to mathematicians of today as sets and functions were to those of last century.

Topology has several different branches — general topology (also known as point-set topology), algebraic topology, differential topology and topological algebra — the first, general topology, being the door to the study of the others. I aim in this book to provide a thorough grounding in general topology. Anyone who conscientiously studies about the first ten chapters and solves at least half of the exercises will certainly have such a grounding.

For the reader who has not previously studied an axiomatic branch of mathematics such as abstract algebra, learning to write proofs will be a hurdle. To assist you to learn how to write proofs, quite often in the early chapters, I include an **aside** which does not form part of the proof but outlines the thought process which led to the proof.

Asides are indicated in the following manner:

In order to arrive at the proof, I went through this thought process, which might well be called the “discovery” or “experiment phase”.

However, the reader will learn that while discovery or experimentation is often essential, nothing can replace a formal proof.

There are many exercises in this book. Only by working through a good number of exercises will you master this course. I have not provided answers to the exercises, and I have no intention of doing so. It is my opinion that there are enough worked examples and proofs within the text itself, that it is not necessary to provide answers to exercises – indeed it is probably undesirable to do so. Very often I include new concepts in the exercises; the concepts which I consider most important will generally be introduced again in the text.

Harder exercises are indicated by an *.

Readers of this book may wish to communicate with each other regarding difficulties, solutions to exercises, comments on thisbook, and further reading. To make this easier I have created a Facebook Group called “Topology Without Tears readers”. You are most welcome to join this group by sending me (s.morris@ballarat.edu.au) an email requesting that.

Finally, I should mention that mathematical advances are best understood when considered in their historical context. This book currently fails to address the historical context sufficiently. For the present I have had to content myself with notes on topology personalities in Appendix 2 - these notes largely being extracted from *The MacTutor History of Mathematics Archive* [206]. The reader is encouraged to visit the website *The MacTutor History of Mathematics Archive* [206] and to read the full articles as well as articles on other key personalities. But a good understanding of history is rarely obtained by reading from just one source.

In the context of history, all I will say here is that much of the topology described in this book was discovered in the first half of the twentieth century. And one could well say that the centre of gravity for this period of discovery is, or was, Poland. (Borders have moved considerably.) It would be fair to say that World War II permanently changed the centre of gravity. The reader should consult Appendix 2 to understand this remark.

0.1 Acknowledgment

Portions of earlier versions of this book were used at La Trobe University, University of New England, University of Wollongong, University of Queensland, University of South Australia, City College of New York, and the University of Ballarat over the last 30 years. I wish to thank those students who criticized the earlier versions and identified errors. Special thanks go to Deborah King and Allison Plant for pointing out numerous errors and weaknesses in the presentation. Thanks also go to several other colleagues including Carolyn McPhail, Ralph Kopperman, Karl Heinrich Hofmann, Rodney Nillsen, Peter Pleasants, Geoffrey Prince, Bevan Thompson and Ewan Barker who read various versions and offered suggestions for improvements. Thanks go to Rod Nillsen whose notes on chaos were useful in preparing the relevant section of Chapter 6. Particular thanks also go to Jack Gray whose excellent University of New South Wales Lecture Notes "Set Theory and Transfinite Arithmetic", written in the 1970s, influenced our Appendix on Infinite Set Theory.

In various places in this book, especially Appendix 2, there are historical notes. I acknowledge two wonderful sources Bourbaki [30] and *The MacTutor History of Mathematics Archive* [206].

0.2 Readers – Locations and Professions

This book has been used by actuaries, astronomers, chemists, computer scientists, econometricians, economists, aeronautical, database, electrical, mechanical, software, spatial & telecommunications engineers, finance students, applied & pure mathematicians, neurophysiologists, options traders, philosophers, physicists, psychologists, software developers, spatial information scientists, and statisticians in Algeria, Argentina, Australia, Austria, Bangladesh, Bolivia, Belarus, Belgium, Belize, Brazil, Bulgaria, Cambodia, Cameroon, Canada, Chile, China, Colombia, Costa Rica, Croatia, Cyprus, Czech Republic, Denmark, Egypt, Estonia, Ethiopia, Fiji, Finland, France, Gaza, Germany, Ghana, Greece, Guyana, Hungary, Iceland, India, Indonesia, Iran, Iraq, Israel, Italy, Jamaica, Japan, Kenya, Korea, Kuwait, Lithuania, Luxembourg, Malaysia, Malta, Mauritius, Mexico, New Zealand, Nicaragua, Nigeria, Norway, Pakistan, Paraguay, Peru, Philippines. Poland, Portugal, Qatar, Romania, Russia, Serbia and Montenegro, Sierra Leone, Singapore, Slovenia, South Africa, Spain, Sri Lanka, Sudan, Sweden, Switzerland, Taiwan, Thailand, The Netherlands, The Phillipines, Trinidad and Tobago, Tunisia, Turkey, United Kingdom, Ukraine, United Arab Emirates, United States of America, Uruguay, Uzbekistan, Venezuela, and Vietnam.

The book is referenced, in particular, on <http://www.econphd.net/notes.htm> a website

designed to make known useful references for “graduate-level course notes in all core disciplines” suitable for Economics students and on Topology Atlas a resource on Topology <http://at.yorku.ca/topology/educ.htm>.

0.3 Readers’ Compliments

T. Lessley, USA: “delightful work, beautifully written”;

E. Ferrer, Australia: “your notes are fantastic”;

E. Yuan, Germany: “it is really a fantastic book for beginners in Topology”;

S. Kumar, India: “very much impressed with the easy treatment of the subject, which can be easily followed by nonmathematicians”;

Pawin Siriprapanukul, Thailand: “I am preparing myself for a Ph.D. (in economics) study and find your book really helpful to the complex subject of topology”;

Hannes Reijner, Sweden: “think it’s excellent”;

G. Gray, USA: “wonderful text”;

Dipak Banik, India: “beautiful note”;

B. Pragoff Jr, USA: “explains topology to an undergrad very well”;

Tapas Kumar Bose, India: “an excellent collection of information”;

Eszter Csernai, Hungary: “I am an undergraduate student student studying Mathematical Economics ... I’m sure that you have heard it many times before, but I will repeat it anyway that the book is absolutely brilliant!”;

Christopher Roe, Australia: “May I first thank you for writing your book ‘Topology without tears’? Although it is probably very basic to you, I have found reading it a completely wonderful experience”;

Jeanine Dorminey, USA: “I am currently taking Topology and I am having an unusual amount of difficulty with the class. I have been reading your book online as it helps so much”;

Tarek Fouda, USA: “I study advanced calculus in Stevens institute of technology to earn masters of science in financial engineering major. It is the first time I am exposed to the subject of topology. I bought few books but I find yours the only that explains the subject in such an interesting way and I wish to have the book with me just to read it in train or school.”

Professor Luis J. Alias, Department of Mathematics at University of Murcia, Spain: “I have just discovered your excellent text “Topology Without Tears”. During this course, I will be teaching a course on General Topology (actually, I will start my course tomorrow morning). I started to teach that course last year, and essentially I followed Munkres’s book (Topology, Second edition),

from which I covered Chapters 2, 3, part of 4, 5, and part of 9. I have been reading your book and I have really enjoyed it. I like it very much, specially the way you introduce new concepts and also the hints and key remarks that you give to the students.”

Gabriele. E.M. Biella MD PhD, Head of Research, Institute of Molecular Bioimaging and Physiology, National Research Council, Italy: “I am a neurophysiologist and am trying to achieve some new neurodynamic description of sensory processes by topological approach. I stepped into your wonderful book.”

Gabriele Luculli, Italy: “I’m just a young student, but I found very interesting the way you propose the topology subject, especially the presence of so many examples”;

K. Orr, USA: “excellent book”;

Professor Ahmed Ould, Colombia: “let me congratulate you for presentation, simplicity and the clearness of the material”;

Paul Unstead, USA: “I like your notes since they provide many concrete examples and do not assume that the reader is a math major”;

Alberto Garca Raboso, Spain: “I like it very much”;

Guiseppe Curci, Research Director in Theoretical Physics, National Institute of Theoretical Physics, Pisa: “nice and illuminating book on topology”;

M. Rinaldi, USA: “this is by far the clearest and best introduction to topology I have ever seen ... when I studied your notes the concepts clicked and your examples are great”;

Joaquin Poblete, Undergraduate Professor of Economics, Catholic University of Chile: “I have just finished reading your book and I really liked it. It is very clear and the examples you give are revealing”;

Alexander Liden, Sweden: “I’ve been enjoying reading your book from the screen but would like to have a printable copy”

Francois Neville, USA: “I am a graduate student in a spatial engineering course at the University of Maine (US), and our professor has enthusiastically recommended your text for the Topology unit.”;

Hsin-Han Shen, USA: “I am a Finance PhD student in State Univ of New York at Buffalo. I found the Topology materials on your website is very detailed and readable, which is an ideal first-course-in topology material for a PhD student who does not major in math, like me”;

Degin Cai, USA: “your book is wonderful”;

Eric Yuan, Darmstadt, Germany: “I am now a mathematics student in Darmstadt University of Technology, studying Topology, and our professor K.H. Hofmann recommended your book ‘Topology Without Tears’ very highly”;

Martin Vu, Oxford University: "I am an Msc student in Applied Math here in oxford. Since I am currently getting used to abstract concepts in maths, the title of the book topology without tears has a natural attraction";

Ahmet Erdem, Turkey: "I liked it a lot";

Wolfgang Moens, Belgium: "I am a Bachelor-student of the "Katholieke Universiteit Leuven. I found myself reading most of the first part of "Topology Without Tears" in a matter of hours. Before I proceed, I must praise you for your clear writing and excellent structure (it certainly did not go unnoticed!)"

Duncan Chen, USA: "You must have received emails like this one many times, but I would still like thanks you for the book 'Topology without Tears'. I am a professional software developer and enjoy reading mathematics."

Maghaisvarei Sellakumaran, Singapore: "I will be going to US to do my PhD in Economics shortly. I found your book on topology to be extremely good";

Tom Hunt, USA: "thank you for making your fine text available on the web";

Fausto Saporito, Italy: "i'm reading your very nice book and this is the best one I saw until now about this subject";
newline Takayuki Osogami, USA: " started reading your "Topology Without Tears" online, and found that it is a very nice material to learn topology as well as general mathematical concept";

Roman Knöll, Germany: "Thank you very much for letting me read your great book. The 'topology without tears' helped me a lot and i regained somehow my interest in mathematics, which was temporarily lost because of unsystematic lectures and superfluous learning by heart";

Yuval Yatskan, USA: "I had a look at the book and it does seem like a marvelous work";

N.S. Mavrogiannis, Greece: "It is a very good work";

Semih Tumen, Turkey: "I know that PhD in Economics programs are mathematically demanding, so I found your book extremely useful while reviewing the necessary topics";

Pyung Ho Kim, USA: "I am currently a Ph.D. student... I am learning economic geography, and i found your book is excellent to learn a basic concept of topology";

Javier Hernandez, Turkey: "I am really grateful to all those, which like you, spend their efforts to share knowledge with the others, without thinking only in the benefit they could get by hiding the candle under the table and getting money to let us spot the light";

J. Chand, Australia: "Many thanks for producing topology without tears. Your book is fantastic.";

Richard VandeVelde, USA: "Two years ago I contacted you about downloading a copy of your "Topology without Tears" for my own use. At that time I was teaching a combined undergraduate / graduate course in topology. I gave the students the URL to access (online) the text. Even

though I did not follow the topics and development in exactly the same order which you do, one of the better students in the class indicated that I should have made that the one and only required text for the course! I think that is a nice recommendation. Well, history repeats itself and two years later I am again teaching the same course to the same sort of audience. So, I would like to be able to download a complete version of the text”;

Professor Sha Xin Wei, Fine Arts and Computer Science, Concordia University, Canada:

“Compliments on your very carefully and humanely written text on topology! I would like to consider adopting it for a course introducing "living" mathematics to ambitious scholarly peers and artists. It's always a pleasure to find works such as yours that reaches out to peers without compromise.”;

Associate Professor Dr Rehana Bari, Bangladesh: “I am a course teacher of Topology in M.Sc. class of the department of Mathematics, University of Dhaka, Bangladesh. Can I have a copy of your wonderful book "Topology Without Tears" for my personal use?”;

Rahul Nilakantan, PhD Student, Department of Economics University of Southern California, USA: “I am a PhD student at the Department of Economics of the University of Southern California, Los Angeles. I hope to work in the area of general equilibrium with incomplete markets. This area requires a thorough understanding of topological concepts. Your excellent book was referred to me by a colleague of mine from Kansas University (a Mr. Ramu Gopalan). After having read part of the book from the non-printable pdf file, I have concluded that this is the book that I want to read to learn topology.”

Long Nguyen, USA “I have never seen any book so clear on such a difficult subject”;

Renato Orellana, Chile: “Congratulations for your great book. I went through the first chapters and had a great time. I thought that topology was out of my reach, now I declare myself an optimist in this matter. ”;

Sisay Regasa Senbeta, Assistant Dean, Faculty of Business and Economics, Addis Ababa University Ethiopia: “I am prospective PhD student of Economics currently a lecturer in Economics at Economics Department of Addis Ababa University, Ethiopia, East Africa. Could you please send me the printable version of your book?”

Nicanor M. Tuan, Davao Oriental State College of Science and Technology, Philippines: “Greetings! I would like to express my gratitude for your unselfish act of sharing your instructional resources, you indeed help me and my students gain topological maturity. Thanks and more power”;

Ernita R. Calayag, Philippines: “I'm Ms. Ernita R. Calayag, a Filipino, student of De La Salle University taking up Ph. D. in Mathematics. I heard good things about your book "Topology Without Tears" and as student of mathematics, I just can't miss the opportunity of having a copy

and enjoy its benefits. I hope that with your approval I can start to understand Topology more as a foundational subject of mathematics.”

Nikola Matejic, Serbia: “Your book is really unique and valuable, suitable for a wide audience. This is a precious gift from You, which is appreciated worldwide. I think that almost everybody who needs to obtain appropriate knowledge in topology can benefit greatly from Your book.”

Iraj Davoodabadi, Iran: “(please excuse me for unsuitable letter) i am mechanical engineer. but i very very interest mathematics (more like to analysis). i am study myself without teacher. some subject in this is difficult for me (for example topology and abstract analysis) because my experient in pure mathematics is'nt high yet. i now study your book(topology whithout tears). this book very very different from other books in this subject and teached me many things which abstract for me until now.[thank you]”;

M.A.R. Khan, Karachi: “thank you for remembering a third world student” .

©Copyright 1985-2007. No part of this book may be reproduced by any process without prior written permission from the author.

Chapter 1

Topological Spaces

Introduction

Tennis, football, baseball and hockey may all be exciting games but to play them you must first learn (some of) the rules of the game. Mathematics is no different. So we begin with the rules for topology.

This chapter opens with the definition of a topology and is then devoted to some simple examples: finite topological spaces, discrete spaces, indiscrete spaces, and spaces with the finite-closed topology.

Topology, like other branches of pure mathematics such as group theory, is an axiomatic subject. We start with a set of axioms and we use these axioms to prove propositions and theorems. It is extremely important to develop your skill at writing proofs.

Why are proofs so important? Suppose our task were to construct a building. We would start with the foundations. In our case these are the axioms or definitions – everything else is built upon them. Each theorem or proposition represents a new level of knowledge and must be firmly anchored to the previous level. We attach the new level to the previous one using a proof. So the theorems and propositions are the new heights of knowledge we achieve, while the proofs are essential as they are the mortar which attaches them to the level below. Without proofs the structure would collapse.

So what is a mathematical proof?

A **mathematical proof** is a watertight argument which begins with information you are given, proceeds by logical argument, and ends with what you are asked to prove.

You should begin a proof by writing down the information you are given and then state what you are asked to prove. If the information you are given or what you are required to prove contains technical terms, then you should write down the definitions of those technical terms.

Every proof should consist of complete sentences. Each of these sentences should be a consequence of (i) what has been stated previously or (ii) a theorem, proposition or lemma that has already been proved.

In this book you will see many proofs, but note that mathematics is not a spectator sport. It is a game for participants. The only way to learn to write proofs is to try to write them yourself.

1.1 Topology

1.1.1 Definitions. Let X be a non-empty set. A collection \mathcal{T} of subsets of X is said to be a **topology** on X if

- (i) X and the empty set, \emptyset , belong to \mathcal{T} ,
- (ii) the union of any (finite or infinite) number of sets in \mathcal{T} belongs to \mathcal{T} , and
- (iii) the intersection of any two sets in \mathcal{T} belongs to \mathcal{T} .

The pair (X, \mathcal{T}) is called a **topological space**.

1.1.2 Example. Let $X = \{a, b, c, d, e, f\}$ and

$$\mathcal{T}_1 = \{X, \emptyset, \{a\}, \{c, d\}, \{a, c, d\}, \{b, c, d, e, f\}\}.$$

Then \mathcal{T}_1 is a topology on X as it satisfies conditions (i), (ii) and (iii) of Definitions 1.1.1. \square

1.1.3 Example. Let $X = \{a, b, c, d, e\}$ and

$$\mathcal{T}_2 = \{X, \emptyset, \{a\}, \{c, d\}, \{a, c, e\}, \{b, c, d\}\}.$$

Then \mathcal{T}_2 is **not** a topology on X as the union

$$\{c, d\} \cup \{a, c, e\} = \{a, c, d, e\}$$

of two members of \mathcal{T}_2 does not belong to \mathcal{T}_2 ; that is, \mathcal{T}_2 does not satisfy condition (ii) of Definitions 1.1.1. \square

1.1.4 Example. Let $X = \{a, b, c, d, e, f\}$ and

$$\mathcal{T}_3 = \{X, \emptyset, \{a\}, \{f\}, \{a, f\}, \{a, c, f\}, \{b, c, d, e, f\}\}.$$

Then \mathcal{T}_3 is **not** a topology on X since the intersection

$$\{a, c, f\} \cap \{b, c, d, e, f\} = \{c, f\}$$

of two sets in \mathcal{T}_3 does not belong to \mathcal{T}_3 ; that is, \mathcal{T}_3 does not have property (iii) of Definitions 1.1.1. □

1.1.5 Example. Let \mathbb{N} be the set of all natural numbers (that is, the set of all positive integers) and let \mathcal{T}_4 consist of \mathbb{N} , \emptyset , and all finite subsets of \mathbb{N} . Then \mathcal{T}_4 is **not** a topology on \mathbb{N} , since the infinite union

$$\{2\} \cup \{3\} \cup \cdots \cup \{n\} \cup \cdots = \{2, 3, \dots, n, \dots\}$$

of members of \mathcal{T}_4 does not belong to \mathcal{T}_4 ; that is, \mathcal{T}_4 does not have property (ii) of Definitions 1.1.1. □

1.1.6 Definitions. Let X be any non-empty set and let \mathcal{T} be the collection of all subsets of X . Then \mathcal{T} is called the **discrete topology** on the set X . The topological space (X, \mathcal{T}) is called a **discrete space**.

We note that \mathcal{T} in Definitions 1.1.6 does satisfy the conditions of Definitions 1.1.1 and so is indeed a topology.

Observe that the set X in Definitions 1.1.6 can be **any** non-empty set. So there is an infinite number of discrete spaces – one for each set X .

1.1.7 Definitions. Let X be any non-empty set and $\mathcal{T} = \{X, \emptyset\}$. Then \mathcal{T} is called the **indiscrete topology** and (X, \mathcal{T}) is said to be an **indiscrete space**.

Once again we have to check that \mathcal{T} satisfies the conditions of Definitions 1.1.1 and so is indeed a topology.

We observe again that the set X in Definitions 1.1.7 can be any non-empty set. So there is an infinite number of indiscrete spaces – one for each set X .

In the introduction to this chapter we discussed the importance of proofs and what is involved in writing them. Our first experience with proofs is in Example 1.1.8 and Proposition 1.1.9. You should study these proofs carefully.

1.1.8 Example. If $X = \{a, b, c\}$ and \mathcal{T} is a topology on X with $\{a\} \in \mathcal{T}$, $\{b\} \in \mathcal{T}$, and $\{c\} \in \mathcal{T}$, prove that \mathcal{T} is the discrete topology.

Proof.

We are given that \mathcal{T} is a topology and that $\{a\} \in \mathcal{T}$, $\{b\} \in \mathcal{T}$, and $\{c\} \in \mathcal{T}$.

We are required to prove that \mathcal{T} is the discrete topology; that is, we are required to prove (by Definitions 1.1.6) that \mathcal{T} contains all subsets of X . Remember that \mathcal{T} is a topology and so satisfies conditions (i), (ii) and (iii) of Definitions 1.1.1.

So we shall begin our proof by writing down all of the subsets of X .

The set X has 3 elements and so it has 2^3 distinct subsets. They are: $S_1 = \emptyset$, $S_2 = \{a\}$, $S_3 = \{b\}$, $S_4 = \{c\}$, $S_5 = \{a, b\}$, $S_6 = \{a, c\}$, $S_7 = \{b, c\}$, and $S_8 = \{a, b, c\} = X$.

We are required to prove that each of these subsets is in \mathcal{T} . As \mathcal{T} is a topology, Definitions 1.1.1 (i) implies that X and \emptyset are in \mathcal{T} ; that is, $S_1 \in \mathcal{T}$ and $S_8 \in \mathcal{T}$.

We are given that $\{a\} \in \mathcal{T}$, $\{b\} \in \mathcal{T}$ and $\{c\} \in \mathcal{T}$; that is, $S_2 \in \mathcal{T}$, $S_3 \in \mathcal{T}$ and $S_4 \in \mathcal{T}$.

To complete the proof we need to show that $S_5 \in \mathcal{T}$, $S_6 \in \mathcal{T}$, and $S_7 \in \mathcal{T}$. But $S_5 = \{a, b\} = \{a\} \cup \{b\}$. As we are given that $\{a\}$ and $\{b\}$ are in \mathcal{T} , Definitions 1.1.1 (ii) implies that their union is also in \mathcal{T} ; that is, $S_5 = \{a, b\} \in \mathcal{T}$.

Similarly $S_6 = \{a, c\} = \{a\} \cup \{c\} \in \mathcal{T}$ and $S_7 = \{b, c\} = \{b\} \cup \{c\} \in \mathcal{T}$. □

In the introductory comments on this chapter we observed that mathematics is not a spectator sport. You should be an active participant. Of course your participation includes doing some of the exercises. But more than this is expected of you. You have to think about the material presented to you.

One of your tasks is to look at the results that we prove and to ask pertinent questions. For example, we have just shown that if each of the singleton sets $\{a\}$, $\{b\}$ and $\{c\}$ is in \mathcal{T} and $X = \{a, b, c\}$, then \mathcal{T} is the discrete topology. You should ask if this is but one example of a more general phenomenon; that is, if (X, \mathcal{T}) is any topological space such that \mathcal{T} contains every singleton set, is \mathcal{T} necessarily the discrete topology? The answer is “yes”, and this is proved in Proposition 1.1.9.

1.1.9 Proposition. If (X, \mathcal{T}) is a topological space such that, for every $x \in X$, the singleton set $\{x\}$ is in \mathcal{T} , then \mathcal{T} is the discrete topology.

Proof.

This result is a generalization of Example 1.1.8. Thus you might expect that the proof would be similar. However, we cannot list all of the subsets of X as we did in Example 1.1.8 because X may be an infinite set. Nevertheless we must prove that **every** subset of X is in \mathcal{T} .

At this point you may be tempted to prove the result for some special cases, for example taking X to consist of 4, 5 or even 100 elements. But this approach is doomed to failure. Recall our opening comments in this chapter where we described a mathematical proof as a watertight argument. We cannot produce a watertight argument by considering a few special cases, or even a very large number of special cases. The watertight argument must cover **all** cases. So we must consider the general case of an arbitrary non-empty set X . Somehow we must prove that every subset of X is in \mathcal{T} .

Looking again at the proof of Example 1.1.8 we see that the key is that every subset of X is a union of singleton subsets of X and we already know that all of the singleton subsets are in \mathcal{T} . This is also true in the general case.

We begin the proof by recording the fact that every set is a union of its singleton subsets. Let S be any subset of X . Then

$$S = \bigcup_{x \in S} \{x\}.$$

Since we are given that each $\{x\}$ is in \mathcal{T} , Definitions 1.1.1 (ii) and the above equation imply that $S \in \mathcal{T}$. As S is an arbitrary subset of X , we have that \mathcal{T} is the discrete topology. \square

That every set S is a union of its singleton subsets is a result which we shall use from time to time throughout the book in many different contexts. Note that it holds even when $S = \emptyset$ as then we form what is called an **empty union** and get \emptyset as the result.

Exercises 1.1

1. Let $X = \{a, b, c, d, e, f\}$. Determine whether or not each of the following collections of subsets of X is a topology on X :

(a) $\mathcal{T}_1 = \{X, \emptyset, \{a\}, \{a, f\}, \{b, f\}, \{a, b, f\}\};$

(b) $\mathcal{T}_2 = \{X, \emptyset, \{a, b, f\}, \{a, b, d\}, \{a, b, d, f\}\};$

(c) $\mathcal{T}_3 = \{X, \emptyset, \{f\}, \{e, f\}, \{a, f\}\}.$

2. Let $X = \{a, b, c, d, e, f\}$. Which of the following collections of subsets of X is a topology on X ? (Justify your answers.)

(a) $\mathcal{T}_1 = \{X, \emptyset, \{c\}, \{b, d, e\}, \{b, c, d, e\}, \{b\}\};$

(b) $\mathcal{T}_2 = \{X, \emptyset, \{a\}, \{b, d, e\}, \{a, b, d\}, \{a, b, d, e\}\};$

(c) $\mathcal{T}_3 = \{X, \emptyset, \{b\}, \{a, b, c\}, \{d, e, f\}, \{b, d, e, f\}\}.$

3. If $X = \{a, b, c, d, e, f\}$ and \mathcal{T} is the discrete topology on X , which of the following statements are true?

(a) $X \in \mathcal{T};$ (b) $\{X\} \in \mathcal{T};$ (c) $\{\emptyset\} \in \mathcal{T};$ (d) $\emptyset \in \mathcal{T};$

(e) $\emptyset \in X;$ (f) $\{\emptyset\} \in X;$ (g) $\{a\} \in \mathcal{T};$ (h) $a \in \mathcal{T};$

(i) $\emptyset \subseteq X;$ (j) $\{a\} \in X;$ (k) $\{\emptyset\} \subseteq X;$ (l) $a \in X;$

(m) $X \subseteq \mathcal{T};$ (n) $\{a\} \subseteq \mathcal{T};$ (o) $\{X\} \subseteq \mathcal{T};$ (p) $a \subseteq \mathcal{T}.$

[Hint. Precisely six of the above are true.]

4. Let (X, \mathcal{T}) be any topological space. Verify that **the intersection of any finite number of members of \mathcal{T} is a member of \mathcal{T} .**

[Hint. To prove this result use “mathematical induction”.]

5. Let \mathbb{R} be the set of all real numbers. Prove that each of the following collections of subsets of \mathbb{R} is a topology.
- (i) \mathcal{T}_1 consists of \mathbb{R} , \emptyset , and every interval $(-n, n)$, for n any positive integer;
 - (ii) \mathcal{T}_2 consists of \mathbb{R} , \emptyset , and every interval $[-n, n]$, for n any positive integer;
 - (iii) \mathcal{T}_3 consists of \mathbb{R} , \emptyset , and every interval $[n, \infty)$, for n any positive integer.
6. Let \mathbb{N} be the set of all positive integers. Prove that each of the following collections of subsets of \mathbb{N} is a topology.
- (i) \mathcal{T}_1 consists of \mathbb{N} , \emptyset , and every set $\{1, 2, \dots, n\}$, for n any positive integer. (This is called the **initial segment topology**.)
 - (ii) \mathcal{T}_2 consists of \mathbb{N} , \emptyset , and every set $\{n, n + 1, \dots\}$, for n any positive integer. (This is called the **final segment topology**.)
7. List all possible topologies on the following sets:
- (a) $X = \{a, b\}$;
 - (b) $Y = \{a, b, c\}$.
8. Let X be an infinite set and \mathcal{T} a topology on X . If every infinite subset of X is in \mathcal{T} , prove that \mathcal{T} is the discrete topology.
- 9.* Let \mathbb{R} be the set of all real numbers. Precisely three of the following ten collections of subsets of \mathbb{R} are topologies? Identify these and justify your answer.
- (i) \mathcal{T}_1 consists of \mathbb{R} , \emptyset , and every interval (a, b) , for a and b any real numbers with $a < b$;
 - (ii) \mathcal{T}_2 consists of \mathbb{R} , \emptyset , and every interval $(-r, r)$, for r any positive real number;
 - (iii) \mathcal{T}_3 consists of \mathbb{R} , \emptyset , and every interval $(-r, r)$, for r any positive rational number;
 - (iv) \mathcal{T}_4 consists of \mathbb{R} , \emptyset , and every interval $[-r, r]$, for r any positive rational number;
 - (v) \mathcal{T}_5 consists of \mathbb{R} , \emptyset , and every interval $(-r, r)$, for r any positive irrational number;
 - (vi) \mathcal{T}_6 consists of \mathbb{R} , \emptyset , and every interval $[-r, r]$, for r any positive irrational number;
 - (vii) \mathcal{T}_7 consists of \mathbb{R} , \emptyset , and every interval $[-r, r)$, for r any positive real number;
 - (viii) \mathcal{T}_8 consists of \mathbb{R} , \emptyset , and every interval $(-r, r]$, for r any positive real number;

- (ix) \mathcal{T}_9 consists of \mathbb{R} , \emptyset , every interval $[-r, r]$, and every interval $(-r, r)$, for r any positive real number;
- (x) \mathcal{T}_{10} consists of \mathbb{R} , \emptyset , every interval $[-n, n]$, and every interval $(-r, r)$, for n any positive integer and r any positive real number.

1.2 Open Sets, Closed Sets, and Clopen Sets

Rather than continually refer to “members of \mathcal{T} ”, we find it more convenient to give such sets a name. We call them “open sets”. We shall also name the complements of open sets. They will be called “closed sets”. This nomenclature is not ideal, but derives from the so-called “open intervals” and “closed intervals” on the real number line. We shall have more to say about this in Chapter 2.

1.2.1 Definition. Let (X, \mathcal{T}) be any topological space. Then the members of \mathcal{T} are said to be **open sets**.

1.2.2 Proposition. If (X, \mathcal{T}) is any topological space, then

- (i) X and \emptyset are open sets,
- (ii) the union of any (finite or infinite) number of open sets is an open set and
- (iii) the intersection of any finite number of open sets is an open set.

Proof. Clearly (i) and (ii) are trivial consequences of Definition 1.2.1 and Definitions 1.1.1 (i) and (ii). The condition (iii) follows from Definition 1.2.1 and Exercises 1.1 #4. \square

On reading Proposition 1.2.2, a question should have popped into your mind: while any finite or infinite union of open sets is open, we state only that finite intersections of open sets are open. Are infinite intersections of open sets always open? The next example shows that the answer is “no”.

1.2.3 Example. Let \mathbb{N} be the set of all positive integers and let \mathcal{T} consist of \emptyset and each subset S of \mathbb{N} such that the complement of S in \mathbb{N} , $\mathbb{N} \setminus S$, is a finite set. It is easily verified that \mathcal{T} satisfies Definitions 1.1.1 and so is a topology on \mathbb{N} . (In the next section we shall discuss this topology further. It is called the finite-closed topology.) For each natural number n , define the set S_n as follows:

$$S_n = \{1\} \cup \{n+1\} \cup \{n+2\} \cup \{n+3\} \cup \cdots = \{1\} \cup \bigcup_{m=n+1}^{\infty} \{m\}.$$

Clearly each S_n is an open set in the topology \mathcal{T} , since its complement is a finite set. However,

$$\bigcap_{n=1}^{\infty} S_n = \{1\}. \quad (1)$$

As the complement of $\{1\}$ is neither \mathbb{N} nor a finite set, $\{1\}$ is not open. So (1) shows that the intersection of the open sets S_n is not open. \square

You might well ask: how did you find the example presented in Example 1.2.3? The answer is unglamorous! It was by trial and error.

If we tried, for example, a discrete topology, we would find that each intersection of open sets is indeed open. The same is true of the indiscrete topology. So what you need to do is some intelligent guesswork.

Remember that to prove that the intersection of open sets is not necessarily open, you need to find just one counterexample!

1.2.4 Definition. Let (X, \mathcal{T}) be a topological space. A subset S of X is said to be a **closed set** in (X, \mathcal{T}) if its complement in X , namely $X \setminus S$, is open in (X, \mathcal{T}) .

In Example 1.1.2, the closed sets are

$$\emptyset, X, \{b, c, d, e, f\}, \{a, b, e, f\}, \{b, e, f\} \text{ and } \{a\}.$$

If (X, \mathcal{T}) is a discrete space, then it is obvious that every subset of X is a closed set. However in an indiscrete space, (X, \mathcal{T}) , the only closed sets are X and \emptyset .

1.2.5 Proposition. If (X, \mathcal{T}) is any topological space, then

- (i) \emptyset and X are closed sets,
- (ii) the intersection of any (finite or infinite) number of closed sets is a closed set and
- (iii) the union of any finite number of closed sets is a closed set.

Proof. (i) follows immediately from Proposition 1.2.2 (i) and Definition 1.2.4, as the complement of X is \emptyset and the complement of \emptyset is X .

To prove that (iii) is true, let S_1, S_2, \dots, S_n be closed sets. We are required to prove that $S_1 \cup S_2 \cup \dots \cup S_n$ is a closed set. It suffices to show, by Definition 1.2.4, that $X \setminus (S_1 \cup S_2 \cup \dots \cup S_n)$ is an open set.

As S_1, S_2, \dots, S_n are closed sets, their complements $X \setminus S_1, X \setminus S_2, \dots, X \setminus S_n$ are open sets. But

$$X \setminus (S_1 \cup S_2 \cup \dots \cup S_n) = (X \setminus S_1) \cap (X \setminus S_2) \cap \dots \cap (X \setminus S_n). \quad (1)$$

As the right hand side of (1) is a finite intersection of open sets, it is an open set. So the left hand side of (1) is an open set. Hence $S_1 \cup S_2 \cup \dots \cup S_n$ is a closed set, as required. So (iii) is true.

The proof of (ii) is similar to that of (iii). [However, you should read the warning in the proof of Example 1.3.9.] □

Warning. The names “open” and “closed” often lead newcomers to the world of topology into error. Despite the names, some open sets are also closed sets! Moreover, some sets are neither open sets nor closed sets! Indeed, if we consider Example 1.1.2 we see that

- (i) the set $\{a\}$ is both open and closed;
- (ii) the set $\{b, c\}$ is neither open nor closed;
- (iii) the set $\{c, d\}$ is open but not closed;
- (iv) the set $\{a, b, e, f\}$ is closed but not open.

In a discrete space every set is both open and closed, while in an indiscrete space (X, \mathcal{T}) , all subsets of X except X and \emptyset are neither open nor closed. \square

To remind you that sets can be both open and closed we introduce the following definition.

1.2.6 Definition. A subset S of a topological space (X, \mathcal{T}) is said to be **clopen** if it is both open and closed in (X, \mathcal{T}) .

In every topological space (X, \mathcal{T}) both X and \emptyset are clopen¹.

In a discrete space all subsets of X are clopen.

In an indiscrete space the only clopen subsets are X and \emptyset .

Exercises 1.2

1. List all 64 subsets of the set X in Example 1.1.2. Write down, next to each set, whether it is (i) clopen; (ii) neither open nor closed; (iii) open but not closed; (iv) closed but not open.
2. Let (X, \mathcal{T}) be a topological space with the property that every subset is closed. Prove that it is a discrete space.

¹We admit that “clopen” is an ugly word but its use is now widespread.

3. Observe that if (X, \mathcal{T}) is a discrete space or an indiscrete space, then every open set is a clopen set. Find a topology \mathcal{T} on the set $X = \{a, b, c, d\}$ which is not discrete and is not indiscrete but has the property that every open set is clopen.
4. Let X be an infinite set. If \mathcal{T} is a topology on X such that every infinite subset of X is closed, prove that \mathcal{T} is the discrete topology.
5. Let X be an infinite set and \mathcal{T} a topology on X with the property that the only infinite subset of X which is open is X itself. Is (X, \mathcal{T}) necessarily an indiscrete space?
6. (i) Let \mathcal{T} be a topology on a set X such that \mathcal{T} consists of precisely four sets; that is, $\mathcal{T} = \{X, \emptyset, A, B\}$, where A and B are non-empty distinct proper subsets of X . [A is a **proper subset** of X means that $A \subseteq X$ and $A \neq X$. This is denoted by $A \subset X$.] Prove that A and B must satisfy exactly one of the following conditions:

$$(a) B = X \setminus A; \quad (b) A \subset B; \quad (c) B \subset A.$$

[Hint. Firstly show that A and B must satisfy at least one of the conditions and then show that they cannot satisfy more than one of the conditions.]

- (ii) Using (i) list all topologies on $X = \{1, 2, 3, 4\}$ which consist of exactly four sets.

1.3 The Finite-Closed Topology

It is usual to define a topology on a set by stating which sets are open. However, sometimes it is more natural to describe the topology by saying which sets are closed. The next definition provides one such example.

1.3.1 Definition. Let X be any non-empty set. A topology \mathcal{T} on X is called the **finite-closed topology** or the **cofinite topology** if the closed subsets of X are X and all finite subsets of X ; that is, the open sets are \emptyset and all subsets of X which have finite complements.

Once again it is necessary to check that \mathcal{T} in Definition 1.3.1 is indeed a topology; that is, that it satisfies each of the conditions of Definitions 1.1.1.

Note that Definition 1.3.1 does not say that every topology which has X and the finite subsets of X closed is the finite-closed topology. These must be the only closed sets. [Of course, in the discrete topology on any set X , the set X and all finite subsets of X are indeed closed, but so too are all other subsets of X .]

In the finite-closed topology all finite sets are closed. However, the following example shows that infinite subsets need not be open sets.

1.3.2 Example. If \mathbb{N} is the set of all positive integers, then sets such as $\{1\}$, $\{5, 6, 7\}$, $\{2, 4, 6, 8\}$ are finite and hence closed in the finite-closed topology. Thus their complements

$$\{2, 3, 4, 5, \dots\}, \{1, 2, 3, 4, 8, 9, 10, \dots\}, \{1, 3, 5, 7, 9, 10, 11, \dots\}$$

are open sets in the finite-closed topology. On the other hand, the set of even positive integers is not a closed set since it is not finite and hence its complement, the set of odd positive integers, is not an open set in the finite-closed topology.

So while all finite sets are closed, not all infinite sets are open. □

1.3.3 Example. Let \mathcal{T} be the finite-closed topology on a set X . If X has at least 3 distinct clopen subsets, prove that X is a finite set.

Proof.

We are given that \mathcal{T} is the finite-closed topology, and that there are at least 3 distinct clopen subsets.

We are required to prove that X is a finite set.

Recall that \mathcal{T} is the finite-closed topology means that the family of all closed sets consists of X and all finite subsets of X . Recall also that a set is clopen if and only if it is both closed and open.

Remember that in every topological space there are at least 2 clopen sets, namely X and \emptyset . (See the comment immediately following Definition 1.2.6.) But we are told that in the space (X, \mathcal{T}) there are at least 3 clopen subsets. This implies that there is a clopen subset other than \emptyset and X . So we shall have a careful look at this other clopen set!

As our space (X, \mathcal{T}) has 3 distinct clopen subsets, we know that there is a clopen subset S of X such that $S \neq X$ and $S \neq \emptyset$. As S is open in (X, \mathcal{T}) , Definition 1.2.4 implies that its complement $X \setminus S$ is a closed set.

Thus S and $X \setminus S$ are closed in the finite-closed topology \mathcal{T} . Therefore S and $X \setminus S$ are both finite, since neither equals X . But $X = S \cup (X \setminus S)$ and so X is the union of two finite sets. Thus X is a finite set, as required. \square

We now know three distinct topologies we can put on any infinite set – and there are many more. The three we know are the discrete topology, the indiscrete topology, and the finite-closed topology. So we must be careful always to specify the topology on a set.

For example, the set $\{n : n \geq 10\}$ is open in the finite-closed topology on the set of natural numbers, but is not open in the indiscrete topology. The set of odd natural numbers is open in the discrete topology on the set of natural numbers, but is not open in the finite-closed topology.

We shall now record some definitions which you have probably met before.

1.3.4 Definitions. Let f be a function from a set X into a set Y .

- (i) The function f is said to be **one-to-one** or **injective** if $f(x_1) = f(x_2)$ implies $x_1 = x_2$, for $x_1, x_2 \in X$;
- (ii) The function f is said to be **onto** or **surjective** if for each $y \in Y$ there exists an $x \in X$ such that $f(x) = y$;
- (iii) The function f is said to be **bijective** if it is both one-to-one and onto.

1.3.5 Definitions. Let f be a function from a set X into a set Y . The function f is said to **have an inverse** if there exists a function g of Y into X such that $g(f(x)) = x$, for all $x \in X$ and $f(g(y)) = y$, for all $y \in Y$. The function g is called an **inverse function** of f .

The proof of the following proposition is left as an exercise for you.

1.3.6 Proposition. Let f be a function from a set X into a set Y .

- (i) The function f has an inverse if and only if f is bijective.
- (ii) Let g_1 and g_2 be functions from Y into X . If g_1 and g_2 are both inverse functions of f , then $g_1 = g_2$; that is, $g_1(y) = g_2(y)$, for all $y \in Y$.
- (iii) Let g be a function from Y into X . Then g is an inverse function of f if and only if f is an inverse function of g .

Warning. It is a very common error for students to think that a function is one-to-one if “it maps one point to one point”.

All functions map one point to one point. Indeed this is part of the definition of a function.

A one-to-one function is a function that maps different points to different points. \square

We now turn to a very important notion that you may not have met before.

1.3.7 Definition. Let f be a function from a set X into a set Y . If S is any subset of Y , then the set $f^{-1}(S)$ is defined by

$$f^{-1}(S) = \{x : x \in X \text{ and } f(x) \in S\}.$$

The subset $f^{-1}(S)$ of X is said to be the **inverse image** of S .

Note that an inverse function of $f: X \rightarrow Y$ exists if and only if f is bijective. But the inverse image of any subset of Y exists even if f is neither one-to-one nor onto. The next example demonstrates this.

1.3.8 Example. Let f be the function from the set of integers, \mathbb{Z} , into itself given by $f(z) = |z|$, for each $z \in \mathbb{Z}$.

The function f is not one-to one, since $f(1) = f(-1)$.

It is also not onto, since there is no $z \in \mathbb{Z}$, such that $f(z) = -1$. So f is certainly not bijective. Hence, by Proposition 1.3.6 (i), f does not have an inverse function. However inverse images certainly exist. For example,

$$f^{-1}(\{1, 2, 3\}) = \{-1, -2, -3, 1, 2, 3\}$$

$$f^{-1}(\{-5, 3, 5, 7, 9\}) = \{-3, -5, -7, -9, 3, 5, 7, 9\}.$$

□

We conclude this section with an interesting example.

1.3.9 Example. Let (Y, \mathcal{T}) be a topological space and X a non-empty set. Further, let f be a function from X into Y . Put $\mathcal{T}_1 = \{f^{-1}(S) : S \in \mathcal{T}\}$. Prove that \mathcal{T}_1 is a topology on X .

Proof.

Our task is to show that the collection of sets, \mathcal{T}_1 , is a topology on X ; that is, we have to show that \mathcal{T}_1 satisfies conditions (i), (ii) and (iii) of Definitions

1.1.1.

$$X \in \mathcal{T}_1 \quad \text{since} \quad X = f^{-1}(Y) \quad \text{and} \quad Y \in \mathcal{T}.$$

$$\emptyset \in \mathcal{T}_1 \quad \text{since} \quad \emptyset = f^{-1}(\emptyset) \quad \text{and} \quad \emptyset \in \mathcal{T}.$$

Therefore \mathcal{T}_1 has property (i) of Definitions 1.1.1.

To verify condition (ii) of Definitions 1.1.1, let $\{A_j : j \in J\}$ be a collection of members of \mathcal{T}_1 , for some index set J . We have to show that $\bigcup_{j \in J} A_j \in \mathcal{T}_1$. As $A_j \in \mathcal{T}_1$, the definition of \mathcal{T}_1 implies that $A_j = f^{-1}(B_j)$, where $B_j \in \mathcal{T}$. Also $\bigcup_{j \in J} A_j = \bigcup_{j \in J} f^{-1}(B_j) = f^{-1}\left(\bigcup_{j \in J} B_j\right)$. [See Exercises 1.3 # 1.]

Now $B_j \in \mathcal{T}$, for all $j \in J$, and so $\bigcup_{j \in J} B_j \in \mathcal{T}$, since \mathcal{T} is a topology on Y . Therefore, by the definition of \mathcal{T}_1 , $f^{-1}\left(\bigcup_{j \in J} B_j\right) \in \mathcal{T}_1$; that is, $\bigcup_{j \in J} A_j \in \mathcal{T}_1$.

So \mathcal{T}_1 has property (ii) of Definitions 1.1.1.

[Warning. You are reminded that not all sets are countable. (See the Appendix for comments on countable sets.) So it would not suffice, in the above argument, to assume that sets $A_1, A_2, \dots, A_n, \dots$ are in \mathcal{T}_1 and show that their union $A_1 \cup A_2 \cup \dots \cup A_n \cup \dots$ is in \mathcal{T}_1 . This would prove only that the union of a countable number of sets in \mathcal{T}_1 lies in \mathcal{T}_1 , but would not show that \mathcal{T}_1 has property (ii) of Definitions 1.1.1 – this property requires all unions, whether countable or uncountable, of sets in \mathcal{T}_1 to be in \mathcal{T}_1 .]

Finally, let A_1 and A_2 be in \mathcal{T}_1 . We have to show that $A_1 \cap A_2 \in \mathcal{T}_1$.

As $A_1, A_2 \in \mathcal{T}_1$, $A_1 = f^{-1}(B_1)$ and $A_2 = f^{-1}(B_2)$, where $B_1, B_2 \in \mathcal{T}$.

$$A_1 \cap A_2 = f^{-1}(B_1) \cap f^{-1}(B_2) = f^{-1}(B_1 \cap B_2).$$

[See Exercises 1.3 #1.]

As $B_1 \cap B_2 \in \mathcal{T}$, we have $f^{-1}(B_1 \cap B_2) \in \mathcal{T}_1$. Hence $A_1 \cap A_2 \in \mathcal{T}_1$, and we have shown that \mathcal{T}_1 also has property (iii) of Definitions 1.1.1.

So \mathcal{T}_1 is indeed a topology on X . □

Exercises 1.3

1. Let f be a function from a set X into a set Y . Then we stated in Example 1.3.9 that

$$f^{-1}\left(\bigcup_{j \in J} B_j\right) = \bigcup_{j \in J} f^{-1}(B_j) \quad (1)$$

and

$$f^{-1}(B_1 \cap B_2) = f^{-1}(B_1) \cap f^{-1}(B_2) \quad (2)$$

for any subsets B_j of Y , and any index set J .

(a) Prove that (1) is true.

[Hint. Start your proof by letting x be any element of the set on the left-hand side and show that it is in the set on the right-hand side. Then do the reverse.]

(b) Prove that (2) is true.

(c) Find (concrete) sets A_1, A_2, X , and Y and a function $f: X \rightarrow Y$ such that $f(A_1 \cap A_2) \neq f(A_1) \cap f(A_2)$, where $A_1 \subseteq X$ and $A_2 \subseteq X$.

2. Is the topology \mathcal{T} described in Exercises 1.1 #6 (ii) the finite-closed topology? (Justify your answer.)

3. A topological space (X, \mathcal{T}) is said to be a **T_1 -space** if every singleton set $\{x\}$ is closed in (X, \mathcal{T}) . Show that precisely two of the following nine topological spaces are T_1 -spaces. (Justify your answer.)
- (i) a discrete space;
 - (ii) an indiscrete space with at least two points;
 - (iii) an infinite set with the finite-closed topology;
 - (iv) Example 1.1.2;
 - (v) Exercises 1.1 #5 (i);
 - (vi) Exercises 1.1 #5 (ii);
 - (vii) Exercises 1.1 #5 (iii);
 - (viii) Exercises 1.1 #6 (i);
 - (ix) Exercises 1.1 #6 (ii).
4. Let \mathcal{T} be the finite-closed topology on a set X . If \mathcal{T} is also the discrete topology, prove that the set X is finite.
5. A topological space (X, \mathcal{T}) is said to be a **T_0 -space** if for each pair of distinct points a, b in X , either there exists an open set containing a and not b , or there exists an open set containing b and not a .
- (i) Prove that every T_1 -space is a T_0 -space.
 - (ii) Which of (i)–(vi) in Exercise 3 above are T_0 -spaces? (Justify your answer.)
 - (iii) Put a topology \mathcal{T} on the set $X = \{0, 1\}$ so that (X, \mathcal{T}) will be a T_0 -space but not a T_1 -space. [The topological space you obtain is called the **Sierpinski space**.]
 - (iv) Prove that each of the topological spaces described in Exercises 1.1 #6 is a T_0 -space. (Observe that in Exercise 3 above we saw that neither is a T_1 -space.)
6. Let X be any infinite set. The **countable-closed topology** is defined to be the topology having as its closed sets X and all countable subsets of X . Prove that this is indeed a topology on X .
7. Let \mathcal{T}_1 and \mathcal{T}_2 be two topologies on a set X . Prove each of the following statements.

- (i) If \mathcal{T}_3 is defined by $\mathcal{T}_3 = \mathcal{T}_1 \cup \mathcal{T}_2$, then \mathcal{T}_3 is not necessarily a topology on X . (Justify your answer, by finding a concrete example.)
- (ii) If \mathcal{T}_4 is defined by $\mathcal{T}_4 = \mathcal{T}_1 \cap \mathcal{T}_2$, then \mathcal{T}_4 is a topology on X . (The topology \mathcal{T}_4 is said to be the **intersection** of the topologies \mathcal{T}_1 and \mathcal{T}_2 .)
- (iii) If (X, \mathcal{T}_1) and (X, \mathcal{T}_2) are T_1 -spaces, then (X, \mathcal{T}_4) is also a T_1 -space.
- (iv) If (X, \mathcal{T}_1) and (X, \mathcal{T}_2) are T_0 -spaces, then (X, \mathcal{T}_4) is not necessarily a T_0 -space. (Justify your answer by finding a concrete example.)
- (v) If $\mathcal{T}_1, \mathcal{T}_2, \dots, \mathcal{T}_n$ are topologies on a set X , then $\mathcal{T} = \bigcap_{i=1}^n \mathcal{T}_i$ is a topology on X .
- (vi) If for each $i \in I$, for some index set I , each \mathcal{T}_i is a topology on the set X , then $\mathcal{T} = \bigcap_{i \in I} \mathcal{T}_i$ is a topology on X .

1.4 Postscript

In this chapter we introduced the fundamental notion of a topological space. As examples we saw various finite spaces, as well as discrete spaces, indiscrete spaces and spaces with the finite-closed topology. None of these is a particularly important example as far as applications are concerned. However, in Exercises 4.3 #8, it is noted that every infinite topological space “contains” an infinite topological space with one of the five topologies: the indiscrete topology, the discrete topology, the finite-closed topology, the initial segment topology, or the final segment topology of Exercises 1.1 #6. In the next chapter we describe the very important euclidean topology.

En route we met the terms “open set” and “closed set” and we were warned that these names can be misleading. Sets can be both open and closed, neither open nor closed, open but not closed, or closed but not open. It is important to remember that we cannot prove that a set is open by proving that it is not closed.

Other than the definitions of topology, topological space, open set, and closed set the most significant topic covered was that of writing proofs.

In the opening comments of this chapter we pointed out the importance of learning to write proofs. In Example 1.1.8, Proposition 1.1.9, and Example 1.3.3 we have seen how to “think through” a proof. It is essential that you develop your own skill at writing proofs. Good exercises to try for this purpose include Exercises 1.1 #8, Exercises 1.2 #2,4, and Exercises 1.3 #1,4.

Some students are confused by the notion of topology as it involves “sets of sets”. To check your understanding, do Exercises 1.1 #3.

The exercises included the notions of T_0 -space and T_1 -space which will be formally introduced later. These are known as **separation properties**.

Finally we emphasize the importance of inverse images. These are dealt with in Example 1.3.9 and Exercises 1.3 #1. Our definition of continuous mapping will rely on inverse images.

Chapter 2

The Euclidean Topology

Introduction

In a movie or a novel there are usually a few central characters about whom the plot revolves. In the story of topology, the euclidean topology on the set of real numbers is one of the central characters. Indeed it is such a rich example that we shall frequently return to it for inspiration and further examination.

Let \mathbb{R} denote the set of all real numbers. In Chapter 1 we defined three topologies that can be put on any set: the discrete topology, the indiscrete topology and the finite-closed topology. So we know three topologies that can be put on the set \mathbb{R} . Six other topologies on \mathbb{R} were defined in Exercises 1.1 #5 and #9. In this chapter we describe a much more important and interesting topology on \mathbb{R} which is known as the euclidean topology.

An analysis of the euclidean topology leads us to the notion of “basis for a topology”. In the study of Linear Algebra we learn that every vector space has a basis and every vector is a linear combination of members of the basis. Similarly, in a topological space every open set can be expressed as a union of members of the basis. Indeed, a set is open if and only if it is a union of members of the basis.

2.1 The Euclidean Topology on \mathbb{R}

2.1.1 Definition. A subset S of \mathbb{R} is said to be open in the **euclidean topology on \mathbb{R}** if it has the following property:

(*) For each $x \in S$, there exist a, b in \mathbb{R} , with $a < b$, such that $x \in (a, b) \subseteq S$.

Notation. Whenever we refer to the topological space \mathbb{R} without specifying the topology, we mean \mathbb{R} with the euclidean topology.

2.1.2 Remarks. (i) The “euclidean topology” \mathcal{T} is a topology.

Proof.

We are required to show that \mathcal{T} satisfies conditions (i), (ii), and (iii) of Definitions 1.1.1.

We are given that a set is in \mathcal{T} if and only if it has property *.

Firstly, we show that $\mathbb{R} \in \mathcal{T}$. Let $x \in \mathbb{R}$. If we put $a = x - 1$ and $b = x + 1$, then $x \in (a, b) \subseteq \mathbb{R}$; that is, \mathbb{R} has property * and so $\mathbb{R} \in \mathcal{T}$. Secondly, $\emptyset \in \mathcal{T}$ as \emptyset has property * by default.

Now let $\{A_j : j \in J\}$, for some index set J , be a family of members of \mathcal{T} . Then we have to show that $\bigcup_{j \in J} A_j \in \mathcal{T}$; that is, we have to show that $\bigcup_{j \in J} A_j$ has property *. Let $x \in \bigcup_{j \in J} A_j$. Then $x \in A_k$, for some $k \in J$. As $A_k \in \mathcal{T}$, there exist a and b in \mathbb{R} with $a < b$ such that $x \in (a, b) \subseteq A_k$. As $k \in J$, $A_k \subseteq \bigcup_{j \in J} A_j$ and so $x \in (a, b) \subseteq \bigcup_{j \in J} A_j$. Hence $\bigcup_{j \in J} A_j$ has property * and thus is in \mathcal{T} , as required.

Finally, let A_1 and A_2 be in \mathcal{T} . We have to prove that $A_1 \cap A_2 \in \mathcal{T}$. So let $y \in A_1 \cap A_2$. Then $y \in A_1$. As $A_1 \in \mathcal{T}$, there exist a and b in \mathbb{R} with $a < b$ such that $y \in (a, b) \subseteq A_1$. Also $y \in A_2 \in \mathcal{T}$. So there exist c and d in \mathbb{R} with $c < d$ such that $y \in (c, d) \subseteq A_2$. Let e be the greater of a and c , and f the smaller of b and d . It is easily checked that $e < y < f$, and so $y \in (e, f)$. As $(e, f) \subseteq (a, b) \subseteq A_1$ and $(e, f) \subseteq (c, d) \subseteq A_2$, we deduce that $y \in (e, f) \subseteq A_1 \cap A_2$. Hence $A_1 \cap A_2$ has property * and so is in \mathcal{T} .

Thus \mathcal{T} is indeed a topology on \mathbb{R} . □

We now proceed to describe the open sets and the closed sets in the euclidean topology on \mathbb{R} . In particular, we shall see that all open intervals are indeed open sets in this topology and all closed intervals are closed sets.

(ii) Let $r, s \in \mathbb{R}$ with $r < s$. In the euclidean topology \mathcal{T} on \mathbb{R} , the open interval (r, s) does indeed belong to \mathcal{T} and so is an open set.

Proof.

We are given the open interval (r, s) .

We must show that (r, s) is open in the euclidean topology; that is, we have to show that (r, s) has property (*) of Definition 2.1.1.

So we shall begin by letting $x \in (r, s)$. We want to find a and b in \mathbb{R} with $a < b$ such that $x \in (a, b) \subseteq (r, s)$.

Let $x \in (r, s)$. Choose $a = r$ and $b = s$. Then clearly

$$x \in (a, b) \subseteq (r, s).$$

So (r, s) is an open set in the euclidean topology. □

(iii) The open intervals (r, ∞) and $(-\infty, r)$ are open sets in \mathbb{R} , for every real number r .

Proof.

Firstly, we shall show that (r, ∞) is an open set; that is, that it has property (*).

To show this we let $x \in (r, \infty)$ and seek $a, b \in \mathbb{R}$ such that

$$x \in (a, b) \subseteq (r, \infty).$$

Let $x \in (r, \infty)$. Put $a = r$ and $b = x + 1$. Then $x \in (a, b) \subseteq (r, \infty)$ and so $(r, \infty) \in \mathcal{T}$.

A similar argument shows that $(-\infty, r)$ is an open set in \mathbb{R} . □

(iv) It is important to note that while every open interval is an open set in \mathbb{R} , the converse is false. **Not all open sets in \mathbb{R} are intervals.** For example, the set $(1, 3) \cup (5, 6)$ is an open set in \mathbb{R} , but it is not an open interval. Even the set $\bigcup_{n=1}^{\infty} (2n, 2n + 1)$ is an open set in \mathbb{R} . \square

(v) For each c and d in \mathbb{R} with $c < d$, the closed interval $[c, d]$ is not an open set in \mathbb{R} .

Proof.

We have to show that $[c, d]$ does not have property (*).

To do this it suffices to find any one x such that there is no a, b having property (*).

Obviously c and d are very special points in the interval $[c, d]$. So we shall choose $x = c$ and show that no a, b with the required property exist.

We use the method of proof called **proof by contradiction**. We suppose that a and b exist with the required property and show that this leads to a contradiction, that is something which is false. Consequently the supposition is false! Hence no such a and b exist. Thus $[c, d]$ does not have property (*) and so is not an open set. □

Observe that $c \in [c, d]$. Suppose there exist a and b in \mathbb{R} with $a < b$ such that $c \in (a, b) \subseteq [c, d]$. Then $c \in (a, b)$ implies $a < c < b$ and so $a < \frac{c+a}{2} < c < b$. Thus $\frac{c+a}{2} \in (a, b)$ and $\frac{c+a}{2} \notin [c, d]$. Hence $(a, b) \not\subseteq [c, d]$, which is a contradiction. So there do not exist a and b such that $c \in (a, b) \subseteq [c, d]$. Hence $[c, d]$ does not have property (*) and so $[c, d] \notin \mathcal{T}$. □

(vi) For each a and b in \mathbb{R} with $a < b$, the closed interval $[a, b]$ is a closed set in the euclidean topology on \mathbb{R} .

Proof. To see that it is closed we have to observe only that its complement $(-\infty, a) \cup (b, \infty)$, being the union of two open sets, is an open set. □

(vii) Each singleton set $\{a\}$ is closed in \mathbb{R} .

Proof. The complement of $\{a\}$ is the union of the two open sets $(-\infty, a)$ and (a, ∞) and so is open. Therefore $\{a\}$ is closed in \mathbb{R} , as required.

[In the terminology of Exercises 1.3 #3, this result says that \mathbb{R} is a T_1 -space.] □

(viii) Note that we could have included (vii) in (vi) simply by replacing “ $a < b$ ” by “ $a \leq b$ ”. The singleton set $\{a\}$ is just the degenerate case of the closed interval $[a, b]$. \square

(ix) The set \mathbb{Z} of all integers is a closed subset of \mathbb{R} .

Proof. The complement of \mathbb{Z} is the union $\bigcup_{n=-\infty}^{\infty} (n, n+1)$ of open subsets $(n, n+1)$ of \mathbb{R} and so is open in \mathbb{R} . Therefore \mathbb{Z} is closed in \mathbb{R} . \square

(x) The set \mathbb{Q} of all rational numbers is neither a closed subset of \mathbb{R} nor an open subset of \mathbb{R} .

Proof.

We shall show that \mathbb{Q} is not an open set by proving that it does not have property (*).

To do this it suffices to show that \mathbb{Q} does not contain any interval (a, b) , with $a < b$.

Suppose that $(a, b) \subseteq \mathbb{Q}$, where a and b are in \mathbb{R} with $a < b$. Between any two distinct real numbers there is an irrational number. (Can you prove this?) Therefore there exists $c \in (a, b)$ such that $c \notin \mathbb{Q}$. This contradicts $(a, b) \subseteq \mathbb{Q}$. Hence \mathbb{Q} does not contain any interval (a, b) , and so is not an open set.

To prove that \mathbb{Q} is not a closed set it suffices to show that $\mathbb{R} \setminus \mathbb{Q}$ is not an open set. Using the fact that between any two distinct real numbers there is a rational number we see that $\mathbb{R} \setminus \mathbb{Q}$ does not contain any interval (a, b) with $a < b$. So $\mathbb{R} \setminus \mathbb{Q}$ is not open in \mathbb{R} and hence \mathbb{Q} is not closed in \mathbb{R} . \square

(xi) In Chapter 3 we shall prove that the only clopen subsets of \mathbb{R} are the trivial ones, namely \mathbb{R} and \emptyset . \square

 Exercises 2.1

1. Prove that if $a, b \in \mathbb{R}$ with $a < b$ then neither $[a, b)$ nor $(a, b]$ is an open subset of \mathbb{R} . Also show that neither is a closed subset of \mathbb{R} .
2. Prove that the sets $[a, \infty)$ and $(-\infty, a]$ are closed subsets of \mathbb{R} .
3. Show, by example, that the union of an infinite number of closed subsets of \mathbb{R} is not necessarily a closed subset of \mathbb{R} .
4. Prove each of the following statements.
 - (i) The set \mathbb{Z} of all integers is not an open subset of \mathbb{R} .
 - (ii) The set S of all prime numbers is a closed subset of \mathbb{R} but not an open subset of \mathbb{R} .
 - (iii) The set \mathbb{P} of all irrational numbers is neither a closed subset nor an open subset of \mathbb{R} .
5. If F is a non-empty finite subset of \mathbb{R} , show that F is closed in \mathbb{R} but that F is not open in \mathbb{R} .
6. If F is a non-empty countable subset of \mathbb{R} , prove that F is not an open set.
7. (i) Let $S = \{0, 1, 1/2, 1/3, 1/4, 1/5, \dots, 1/n, \dots\}$. Prove that the set S is closed in the euclidean topology on \mathbb{R} .
 - (ii) Is the set $T = \{1, 1/2, 1/3, 1/4, 1/5, \dots, 1/n, \dots\}$ closed in \mathbb{R} ?
 - (iii) Is the set $\{\sqrt{2}, 2\sqrt{2}, 3\sqrt{2}, \dots, n\sqrt{2}, \dots\}$ closed in \mathbb{R} ?
8. (i) Let (X, \mathcal{T}) be a topological space. A subset S of X is said to be an **F_σ -set** if it is the union of a countable number of closed sets. Prove that all open intervals (a, b) and all closed intervals $[a, b]$, are F_σ -sets in \mathbb{R} .
 - (ii) Let (X, \mathcal{T}) be a topological space. A subset T of X is said to be a **G_δ -set** if it is the intersection of a countable number of open sets. Prove that all open intervals (a, b) and all closed intervals $[a, b]$ are G_δ -sets in \mathbb{R} .
 - (iii) Prove that the set \mathbb{Q} of rationals is an F_σ -set in \mathbb{R} . (In Exercises 6.5#3 we prove that \mathbb{Q} is not a G_δ -set in \mathbb{R} .)
 - (iv) Verify that the complement of an F_σ -set is a G_δ -set and the complement of a G_δ -set is an F_σ -set.

2.2 Basis for a Topology

Remarks 2.1.2 allow us to describe the euclidean topology on \mathbb{R} in a much more convenient manner. To do this, we introduce the notion of a basis for a topology.

2.2.1 Proposition. A subset S of \mathbb{R} is open if and only if it is a union of open intervals.

Proof.

We are required to prove that S is open if and only if it is a union of open intervals; that is, we have to show that

- (i) if S is a union of open intervals, then it is an open set, and
- (ii) if S is an open set, then it is a union of open intervals.

Assume that S is a union of open intervals; that is, there exist open intervals (a_j, b_j) , where j belongs to some index set J , such that $S = \bigcup_{j \in J} (a_j, b_j)$. By Remarks 2.1.2 (ii) each open interval (a_j, b_j) is an open set. Thus S is a union of open sets and so S is an open set.

Conversely, assume that S is open in \mathbb{R} . Then for each $x \in S$, there exists an interval $I_x = (a, b)$ such that $x \in I_x \subseteq S$. We now claim that $S = \bigcup_{x \in S} I_x$.

We are required to show that the two sets S and $\bigcup_{x \in S} I_x$ are equal.

These sets are shown to be equal by proving that

- (i) if $y \in S$, then $y \in \bigcup_{x \in S} I_x$, and
- (ii) if $z \in \bigcup_{x \in S} I_x$, then $z \in S$.

[Note that (i) is equivalent to the statement $S \subseteq \bigcup_{x \in S} I_x$, while (ii) is equivalent to $\bigcup_{x \in S} I_x \subseteq S$.]

Firstly let $y \in S$. Then $y \in I_y$. So $y \in \bigcup_{x \in S} I_x$, as required. Secondly, let $z \in \bigcup_{x \in S} I_x$. Then $z \in I_t$, for some $t \in S$. As each $I_x \subseteq S$, we see that $I_t \subseteq S$ and so $z \in S$. Hence $S = \bigcup_{x \in S} I_x$, and we have that S is a union of open intervals, as required. \square

The above proposition tells us that in order to describe the topology of \mathbb{R} it suffices to say that all intervals (a, b) are open sets. Every other open set is a union of these open sets. This leads us to the following definition.

2.2.2 Definition. Let (X, \mathcal{T}) be a topological space. A collection \mathcal{B} of open subsets of X is said to be a **basis** for the topology \mathcal{T} if every open set is a union of members of \mathcal{B} .

If \mathcal{B} is a basis for a topology \mathcal{T} on a set X then a subset U of X is in \mathcal{T} if and only if it is a union of members of \mathcal{B} . So \mathcal{B} “generates” the topology \mathcal{T} in the following sense: if we are told what sets are members of \mathcal{B} then we can determine the members of \mathcal{T} – they are just all the sets which are unions of members of \mathcal{B} .

2.2.3 Example. Let $\mathcal{B} = \{(a, b) : a, b \in \mathbb{R}, a < b\}$. Then \mathcal{B} is a basis for the euclidean topology on \mathbb{R} , by Proposition 2.2.1. □

2.2.4 Example. Let (X, \mathcal{T}) be a discrete space and \mathcal{B} the family of all singleton subsets of X ; that is, $\mathcal{B} = \{\{x\} : x \in X\}$. Then, by Proposition 1.1.9, \mathcal{B} is a basis for \mathcal{T} . □

2.2.5 Example. Let $X = \{a, b, c, d, e, f\}$ and

$$\mathcal{T}_1 = \{X, \emptyset, \{a\}, \{c, d\}, \{a, c, d\}, \{b, c, d, e, f\}\}.$$

Then $\mathcal{B} = \{\{a\}, \{c, d\}, \{b, c, d, e, f\}\}$ is a basis for \mathcal{T}_1 as $\mathcal{B} \subseteq \mathcal{T}_1$ and every member of \mathcal{T}_1 can be expressed as a union of members of \mathcal{B} . (Observe that \emptyset is an empty union of members of \mathcal{B} .)

Note that \mathcal{T}_1 itself is also a basis for \mathcal{T}_1 . □

2.2.6 Remark. Observe that if (X, \mathcal{T}) is a topological space then $\mathcal{B} = \mathcal{T}$ is a basis for the topology \mathcal{T} . So, for example, the set of all subsets of X is a basis for the discrete topology on X .

We see, therefore, that [there can be many different bases for the same topology](#). Indeed if \mathcal{B} is a basis for a topology \mathcal{T} on a set X and \mathcal{B}_1 is a collection of subsets of X such that $\mathcal{B} \subseteq \mathcal{B}_1 \subseteq \mathcal{T}$, then \mathcal{B}_1 is also a basis for \mathcal{T} . [Verify this.] □

As indicated above the notion of “basis for a topology” allows us to define topologies. However the following example shows that we must be careful.

2.2.7 Example. Let $X = \{a, b, c\}$ and $\mathcal{B} = \{\{a\}, \{c\}, \{a, b\}, \{b, c\}\}$. Then \mathcal{B} is not a basis for any topology on X . To see this, suppose that \mathcal{B} is a basis for a topology \mathcal{T} . Then \mathcal{T} consists of all unions of sets in \mathcal{B} ; that is,

$$\mathcal{T} = \{X, \emptyset, \{a\}, \{c\}, \{a, c\}, \{a, b\}, \{b, c\}\}.$$

(Once again we use the fact that \emptyset is an empty union of members of \mathcal{B} and so $\emptyset \in \mathcal{T}$.)

However, \mathcal{T} is not a topology since the set $\{b\} = \{a, b\} \cap \{b, c\}$ is not in \mathcal{T} and so \mathcal{T} does not have property (iii) of Definitions 1.1.1. This is a contradiction, and so our supposition is false. Thus \mathcal{B} is not a basis for any topology on X . □

Thus we are led to ask: if \mathcal{B} is a collection of subsets of X , under what conditions is \mathcal{B} a basis for a topology? This question is answered by Proposition 2.2.8.

2.2.8 Proposition. Let X be a non-empty set and let \mathcal{B} be a collection of subsets of X . Then \mathcal{B} is a basis for a topology on X if and only if \mathcal{B} has the following properties:

- (a) $X = \bigcup_{B \in \mathcal{B}} B$, and
- (b) for any $B_1, B_2 \in \mathcal{B}$, the set $B_1 \cap B_2$ is a union of members of \mathcal{B} .

Proof. If \mathcal{B} is a basis for a topology \mathcal{T} then \mathcal{T} must have the properties (i), (ii), and (iii) of Definitions 1.1.1. In particular X must be an open set and the intersection of any two open sets must be an open set. As the open sets are just the unions of members of \mathcal{B} , this implies that (a) and (b) above are true.

Conversely, assume that \mathcal{B} has properties (a) and (b) and let \mathcal{T} be the collection of all subsets of X which are unions of members of \mathcal{B} . We shall show that \mathcal{T} is a topology on X . (If so then \mathcal{B} is obviously a basis for this topology \mathcal{T} and the proposition is true.)

By (a), $X = \bigcup_{B \in \mathcal{B}} B$ and so $X \in \mathcal{T}$. Note that \emptyset is an empty union of members of \mathcal{B} and so $\emptyset \in \mathcal{T}$. So we see that \mathcal{T} does have property (i) of Definitions 1.1.1.

Now let $\{T_j\}$ be a family of members of \mathcal{T} . Then each T_j is a union of members of \mathcal{B} . Hence the union of all the T_j is also a union of members of \mathcal{B} and so is in \mathcal{T} . Thus \mathcal{T} also satisfies condition (ii) of Definitions 1.1.1.

Finally let C and D be in \mathcal{T} . We need to verify that $C \cap D \in \mathcal{T}$. But $C = \bigcup_{k \in K} B_k$, for some index set K and sets $B_k \in \mathcal{B}$. Also $D = \bigcup_{j \in J} B_j$, for some index set J and $B_j \in \mathcal{B}$. Therefore

$$C \cap D = \left(\bigcup_{k \in K} B_k \right) \cap \left(\bigcup_{j \in J} B_j \right) = \bigcup_{k \in K, j \in J} (B_k \cap B_j).$$

You should verify that the two expressions for $C \cap D$ are indeed equal!

In the finite case this involves statements like

$$(B_1 \cup B_2) \cap (B_3 \cup B_4) = (B_1 \cap B_3) \cup (B_1 \cap B_4) \cup (B_2 \cap B_3) \cup (B_2 \cap B_4).$$

By our assumption (b), each $B_k \cap B_j$ is a union of members of \mathcal{B} and so $C \cap D$ is a union of members of \mathcal{B} . Thus $C \cap D \in \mathcal{T}$. So \mathcal{T} has property (iii) of Definition 1.1.1. Hence \mathcal{T} is indeed a topology, and \mathcal{B} is a basis for this topology, as required. \square

Proposition 2.2.8 is a very useful result. It allows us to define topologies by simply writing down a basis. This is often easier than trying to describe all of the open sets.

We shall now use this Proposition to define a topology on the plane. This topology is known as the “euclidean topology”.

2.2.9 Example. Let \mathcal{B} be the collection of all “open rectangles”

$\{\langle x, y \rangle : \langle x, y \rangle \in \mathbb{R}^2, a < x < b, c < y < d\}$ in the plane which have each side parallel to the X - or Y -axis.

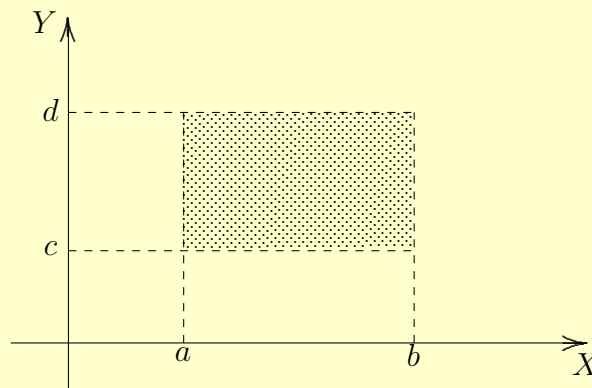

Then \mathcal{B} is a basis for a topology on the plane. This topology is called the euclidean topology.

Whenever we use the symbol \mathbb{R}^2 we mean the plane, and if we refer to \mathbb{R}^2 as a topological space without explicitly saying what the topology is, we mean the plane with the euclidean topology.

To see that \mathcal{B} is indeed a basis for a topology, observe that (i) the plane is the union of all of the open rectangles, and (ii) the intersection of any two rectangles is a rectangle. [By “rectangle” we mean one with sides parallel to the axes.] So the conditions of Proposition 2.2.8 are satisfied and hence \mathcal{B} is a basis for a topology. □

2.2.10 Remark. By generalizing Example 2.2.9 we see how to put a topology on

$$\mathbb{R}^n = \{\langle x_1, x_2, \dots, x_n \rangle : x_i \in \mathbb{R}, i = 1, \dots, n\}, \quad \text{for each integer } n > 2.$$

We let \mathcal{B} be the collection of all subsets $\{\langle x_1, x_2, \dots, x_n \rangle \in \mathbb{R}^n : a_i < x_i < b_i, i = 1, 2, \dots, n\}$ of \mathbb{R}^n with sides parallel to the axes. This collection \mathcal{B} is a basis for the **euclidean topology** on \mathbb{R}^n . □

 Exercises 2.2

1. In this exercise you will prove that disc $\{\langle x, y \rangle : x^2 + y^2 < 1\}$ is an open subset of \mathbb{R}^2 , and then that every open disc in the plane is an open set.

(i) Let $\langle a, b \rangle$ be any point in the disc $D = \{\langle x, y \rangle : x^2 + y^2 < 1\}$. Put $r = \sqrt{a^2 + b^2}$. Let $R_{\langle a, b \rangle}$ be the open rectangle with vertices at the points $\langle a \pm \frac{1-r}{8}, b \pm \frac{1-r}{8} \rangle$. Verify that $R_{\langle a, b \rangle} \subset D$.

(ii) Using (i) show that

$$D = \bigcup_{\langle a, b \rangle \in D} R_{\langle a, b \rangle}.$$

(iii) Deduce from (ii) that D is an open set in \mathbb{R}^2 .

(iv) Show that every disc $\{\langle x, y \rangle : (x - a)^2 + (y - b)^2 < c^2, a, b, c \in \mathbb{R}\}$ is open in \mathbb{R}^2 .

2. In this exercise you will show that the collection of all open discs in \mathbb{R}^2 is a basis for a topology on \mathbb{R}^2 . [Later we shall see that this is the euclidean topology.]

(i) Let D_1 and D_2 be any open discs in \mathbb{R}^2 with $D_1 \cap D_2 \neq \emptyset$. If $\langle a, b \rangle$ is any point in $D_1 \cap D_2$, show that there exists an open disc $D_{\langle a, b \rangle}$ with centre $\langle a, b \rangle$ such that $D_{\langle a, b \rangle} \subset D_1 \cap D_2$. [Hint: draw a picture and use a method similar to that of Exercise 1 (i).]

(ii) Show that

$$D_1 \cap D_2 = \bigcup_{\langle a, b \rangle \in D_1 \cap D_2} D_{\langle a, b \rangle}.$$

(iii) Using (ii) and Proposition 2.2.8, prove that the collection of all open discs in \mathbb{R}^2 is a basis for a topology on \mathbb{R}^2 .

3. Let \mathcal{B} be the collection of all open intervals (a, b) in \mathbb{R} with $a < b$ and a and b rational numbers. Prove that \mathcal{B} is a basis for the euclidean topology on \mathbb{R} . [Compare this with Proposition 2.2.1 and Example 2.2.3 where a and b were not necessarily rational.]

[Hint: do not use Proposition 2.2.8 as this would show only that \mathcal{B} is a basis for some topology not necessarily a basis for the euclidean topology.]

4. A topological space (X, \mathcal{T}) is said to satisfy the **second axiom of countability** if there exists a basis \mathcal{B} for \mathcal{T} such that \mathcal{B} consists of only a countable number of sets.

- (i) Using Exercise 3 above show that \mathbb{R} satisfies the second axiom of countability.
- (ii) Prove that the discrete topology on an uncountable set does not satisfy the second axiom of countability.

[Hint. It is not enough to show that one particular basis is uncountable. You must prove that every basis for this topology is uncountable.]

- (iii) Prove that \mathbb{R}^n satisfies the second axiom of countability, for each positive integer n .
- (iv) Let (X, \mathcal{T}) be the set of all integers with the finite-closed topology. Does the space (X, \mathcal{T}) satisfy the second axiom of countability?

5. Prove the following statements.

- (i) Let m and c be real numbers, with $m \neq 0$. Then the line $L = \{\langle x, y \rangle : y = mx + c\}$ is a closed subset of \mathbb{R}^2 .
- (ii) Let \mathbb{S}^1 be the unit circle given by $\mathbb{S}^1 = \{\langle x, y \rangle \in \mathbb{R}^2 : x^2 + y^2 = 1\}$. Then \mathbb{S}^1 is a closed subset of \mathbb{R}^2 .
- (iii) Let \mathbb{S}^n be the unit n -sphere given by

$$\mathbb{S}^n = \{\langle x_1, x_2, \dots, x_n, x_{n+1} \rangle \in \mathbb{R}^{n+1} : x_1^2 + x_2^2 + \dots + x_{n+1}^2 = 1\}.$$

Then \mathbb{S}^n is a closed subset of \mathbb{R}^{n+1} .

- (iv) Let B^n be the closed unit n -ball given by

$$B^n = \{\langle x_1, x_2, \dots, x_n \rangle \in \mathbb{R}^n : x_1^2 + x_2^2 + \dots + x_n^2 \leq 1\}.$$

Then B^n is a closed subset of \mathbb{R}^n .

- (v) The curve $C = \{\langle x, y \rangle \in \mathbb{R}^2 : xy = 1\}$ is a closed subset of \mathbb{R}^2 .

6. Let \mathcal{B}_1 be a basis for a topology \mathcal{T}_1 on a set X and \mathcal{B}_2 a basis for a topology \mathcal{T}_2 on a set Y . The set $X \times Y$ consists of all ordered pairs $\langle x, y \rangle$, $x \in X$ and $y \in Y$. Let \mathcal{B} be the collection of subsets of $X \times Y$ consisting of all the sets $B_1 \times B_2$ where $B_1 \in \mathcal{B}_1$ and $B_2 \in \mathcal{B}_2$. Prove that \mathcal{B} is a basis for a topology on $X \times Y$. The topology so defined is called the **product topology** on $X \times Y$.

[Hint. See Example 2.2.9.]

7. Using Exercise 3 above and Exercises 2.1 #8, prove that every open subset of \mathbb{R} is an F_σ -set and a G_δ -set.

2.3 Basis for a Given Topology

Proposition 2.2.8 told us under what conditions a collection \mathcal{B} of subsets of a set X is a basis for some topology on X . However sometimes we are given a topology \mathcal{T} on X and we want to know whether \mathcal{B} is a basis for this specific topology \mathcal{T} . To verify that \mathcal{B} is a basis for \mathcal{T} we could simply apply Definition 2.2.2 and show that every member of \mathcal{T} is a union of members of \mathcal{B} . However, Proposition 2.3.2 provides us with an alternative method.

But first we present an example which shows that there is a difference between saying that a collection \mathcal{B} of subsets of X is a basis for some topology, and saying that it is a basis for a given topology.

2.3.1 Example. Let \mathcal{B} be the collection of all half-open intervals of the form $(a, b]$, $a < b$, where $(a, b] = \{x : x \in \mathbb{R}, a < x \leq b\}$. Then \mathcal{B} is a basis for a topology on \mathbb{R} , since \mathbb{R} is the union of all members of \mathcal{B} and the intersection of any two half-open intervals is a half-open interval.

However, the topology \mathcal{T}_1 which has \mathcal{B} as its basis, is not the euclidean topology on \mathbb{R} . We can see this by observing that $(a, b]$ is an open set in \mathbb{R} with topology \mathcal{T}_1 , while $(a, b]$ is not an open set in \mathbb{R} with the euclidean topology. (See Exercises 2.1 #1.) So \mathcal{B} is a basis for some topology but not a basis for the euclidean topology on \mathbb{R} . \square

2.3.2 Proposition. Let (X, \mathcal{T}) be a topological space. A family \mathcal{B} of open subsets of X is a basis for \mathcal{T} if and only if for any point x belonging to any open set U , there is a $B \in \mathcal{B}$ such that $x \in B \subseteq U$.

Proof.

We are required to prove that

- (i) if \mathcal{B} is a basis for \mathcal{T} and $x \in U \in \mathcal{T}$, then there exists a $B \in \mathcal{B}$ such that $x \in B \subseteq U$,
 and
 (ii) if for each $U \in \mathcal{T}$ and $x \in U$ there exists a $B \in \mathcal{B}$ such that $x \in B \subseteq U$, then \mathcal{B} is a basis for \mathcal{T} .

Assume \mathcal{B} is a basis for \mathcal{T} and $x \in U \in \mathcal{T}$. As \mathcal{B} is a basis for \mathcal{T} , the open set U is a union of members of \mathcal{B} ; that is, $U = \bigcup_{j \in J} B_j$, where $B_j \in \mathcal{B}$, for each j in some index set J . But $x \in U$ implies $x \in B_j$, for some $j \in J$. Thus $x \in B_j \subseteq U$, as required.

Conversely, assume that for each $U \in \mathcal{T}$ and each $x \in U$, there exists a $B \in \mathcal{B}$ with $x \in B \subseteq U$. We have to show that every open set is a union of members of \mathcal{B} . So let V be any open set. Then for each $x \in V$, there is a $B_x \in \mathcal{B}$ such that $x \in B_x \subseteq V$. Clearly $V = \bigcup_{x \in V} B_x$. (Check this!) Thus V is a union of members of \mathcal{B} . \square

2.3.3 Proposition. Let \mathcal{B} be a basis for a topology \mathcal{T} on a set X . Then a subset U of X is open if and only if for each $x \in U$ there exists a $B \in \mathcal{B}$ such that $x \in B \subseteq U$.

Proof. Let U be any subset of X . Assume that for each $x \in U$, there exists a $B_x \in \mathcal{B}$ such that $x \in B_x \subseteq U$. Clearly $U = \bigcup_{x \in U} B_x$. So U is a union of open sets and hence is open, as required. The converse statement follows from Proposition 2.3.2. \square

Observe that the basis property described in Proposition 2.3.3 is precisely what we used in defining the euclidean topology on \mathbb{R} . We said that a subset U of \mathbb{R} is open if and only if for each $x \in U$, there exist a and b in \mathbb{R} with $a < b$, such that $x \in (a, b) \subseteq U$.

Warning. Make sure that you understand the difference between Proposition 2.2.8 and Proposition 2.3.2. Proposition 2.2.8 gives conditions for a family \mathcal{B} of subsets of a set X to be a basis for some topology on X . However, Proposition 2.3.2 gives conditions for a family \mathcal{B} of subsets of a topological space (X, \mathcal{T}) to be a basis for the given topology \mathcal{T} .

We have seen that a topology can have many different bases. The next proposition tells us when two bases \mathcal{B}_1 and \mathcal{B}_2 on the same set X define the same topology.

2.3.4 Proposition. Let \mathcal{B}_1 and \mathcal{B}_2 be bases for topologies \mathcal{T}_1 and \mathcal{T}_2 , respectively, on a non-empty set X . Then $\mathcal{T}_1 = \mathcal{T}_2$ if and only if

- (i) for each $B \in \mathcal{B}_1$ and each $x \in B$, there exists a $B' \in \mathcal{B}_2$ such that $x \in B' \subseteq B$, and
- (ii) for each $B \in \mathcal{B}_2$ and each $x \in B$, there exists a $B' \in \mathcal{B}_1$ such that $x \in B' \subseteq B$.

Proof.

We are required to show that \mathcal{B}_1 and \mathcal{B}_2 are bases for the same topology if and only if (i) and (ii) are true.

Firstly we assume that they are bases for the same topology, that is $\mathcal{T}_1 = \mathcal{T}_2$, and show that conditions (i) and (ii) hold.

Next we assume that (i) and (ii) hold and show that $\mathcal{T}_1 = \mathcal{T}_2$.

Firstly, assume that $\mathcal{T}_1 = \mathcal{T}_2$. Then (i) and (ii) are immediate consequences of Proposition 2.3.2.

Conversely, assume that \mathcal{B}_1 and \mathcal{B}_2 satisfy the conditions (i) and (ii). By Proposition 2.3.2, (i) implies that each $B \in \mathcal{B}_1$ is open in (X, \mathcal{T}_2) ; that is, $\mathcal{B}_1 \subseteq \mathcal{T}_2$. As every member of \mathcal{T}_1 is a union of members of \mathcal{T}_2 this implies $\mathcal{T}_1 \subseteq \mathcal{T}_2$. Similarly (ii) implies $\mathcal{T}_2 \subseteq \mathcal{T}_1$. Hence $\mathcal{T}_1 = \mathcal{T}_2$, as required. \square

2.3.5 Example. Show that the set \mathcal{B} of all “open equilateral triangles” with base parallel to the X -axis is a basis for the euclidean topology on \mathbb{R}^2 . (By an “open triangle” we mean that the boundary is not included.)

Outline Proof. (We give here only a pictorial argument. It is left to you to write a detailed proof.)

We are required to show that \mathcal{B} is a basis for the euclidean topology.

We shall apply Proposition 2.3.4, but first we need to show that \mathcal{B} is a basis for some topology on \mathbb{R}^2 .

To do this we show that \mathcal{B} satisfies the conditions of Proposition 2.2.8.

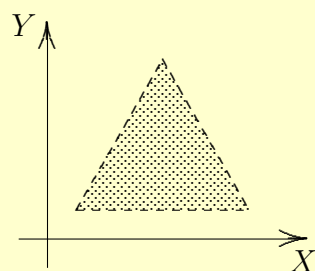

The first thing we observe is that \mathcal{B} is a basis for some topology because it satisfies the conditions of Proposition 2.2.8. (To see that \mathcal{B} satisfies Proposition 2.2.8, observe that \mathbb{R}^2 equals the union of all open equilateral triangles with base parallel to the X -axis, and that the intersection of two such triangles is another such triangle.)

Next we shall show that the conditions (i) and (ii) of Proposition 2.3.4 are satisfied.

Firstly we verify condition (i). Let R be an open rectangle with sides parallel to the axes and any x any point in R . We have to show that there is an open equilateral triangle T with base parallel to the X -axis such that $x \in T \subseteq R$. Pictorially this is easy to see.

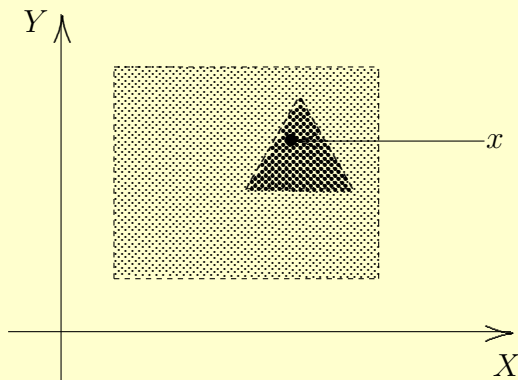

Finally we verify condition (ii) of Proposition 2.3.4. Let T' be an open equilateral triangle with base parallel to the X -axis and let y be any point in T' . Then there exists an open rectangle R' such that $y \in R' \subseteq T'$. Pictorially, this is again easy to see.

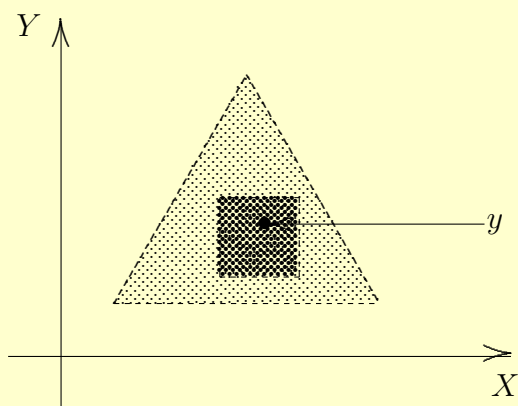

So the conditions of Proposition 2.3.4 are satisfied. Thus \mathcal{B} is indeed a basis for the euclidean topology on \mathbb{R}^2 . □

In Example 2.2.9 we defined a basis for the euclidean topology to be the collection of all “open rectangles” (with sides parallel to the axes). Example 2.3.5 shows that “open rectangles” can be replaced by “open equilateral triangles” (with base parallel to the X -axis) without changing the topology. In Exercises 2.3 #1 we see that the conditions above in brackets can be dropped without changing the topology. Also “open rectangles” can be replaced by “open discs”¹.

¹In fact, most books describe the euclidean topology on \mathbb{R}^2 in terms of open discs.

 Exercises 2.3

1. Determine whether or not each of the following collections is a basis for the euclidean topology on \mathbb{R}^2 :
 - (i) the collection of all “open” squares with sides parallel to the axes;
 - (ii) the collection of all “open” discs;
 - (iii) the collection of all “open” squares;
 - (iv) the collection of all “open” rectangles.
 - (v) the collection of all “open” triangles

2. (i) Let \mathcal{B} be a basis for a topology on a non-empty set X . If \mathcal{B}_1 is a collection of subsets of X such that $\mathcal{T} \supseteq \mathcal{B}_1 \supseteq \mathcal{B}$, prove that \mathcal{B}_1 is also a basis for \mathcal{T} .
 - (ii) Deduce from (i) that there exist an uncountable number of distinct bases for the euclidean topology on \mathbb{R} .

3. Let $\mathcal{B} = \{(a, b) : a, b \in \mathbb{R}, a < b\}$. As seen in Example 2.3.1, \mathcal{B} is a basis for a topology \mathcal{T} on \mathbb{R} and \mathcal{T} is not the euclidean topology on \mathbb{R} . Nevertheless, show that each interval (a, b) is open in $(\mathbb{R}, \mathcal{T})$.

- 4.* Let $C[0, 1]$ be the set of all continuous real-valued functions on $[0, 1]$.
 - (i) Show that the collection \mathcal{M} , where $\mathcal{M} = \{M(f, \varepsilon) : f \in C[0, 1] \text{ and } \varepsilon \text{ is a positive real number}\}$ and $M(f, \varepsilon) = \{g : g \in C[0, 1] \text{ and } \int_0^1 |f - g| < \varepsilon\}$, is a basis for a topology \mathcal{T}_1 on $C[0, 1]$.
 - (ii) Show that the collection \mathcal{U} , where $\mathcal{U} = \{U(f, \varepsilon) : f \in C[0, 1] \text{ and } \varepsilon \text{ is a positive real number}\}$ and $U(f, \varepsilon) = \{g : g \in C[0, 1] \text{ and } \sup_{x \in [0, 1]} |f(x) - g(x)| < \varepsilon\}$, is a basis for a topology \mathcal{T}_2 on $C[0, 1]$.
 - (iii) Prove that $\mathcal{T}_1 \neq \mathcal{T}_2$.

5. Let (X, \mathcal{T}) be a topological space. A non-empty collection \mathcal{S} of open subsets of X is said to be a **subbasis** for \mathcal{T} if the collection of all finite intersections of members of \mathcal{S} forms a basis for \mathcal{T} .
- (i) Prove that the collection of all open intervals of the form (a, ∞) or $(-\infty, b)$ is a subbasis for the euclidean topology on \mathbb{R} .
- (ii) Prove that $\mathcal{S} = \{\{a\}, \{a, c, d\}, \{b, c, d, e, f\}\}$ is a subbasis for the topology \mathcal{T}_1 of Example 1.1.2.
6. Let \mathcal{S} be a subbasis for a topology \mathcal{T} on the set \mathbb{R} . (See Exercise 5 above.) If all of the closed intervals $[a, b]$, with $a < b$, are in \mathcal{S} , prove that \mathcal{T} is the discrete topology.
7. Let X be a non-empty set and \mathcal{S} the collection of all sets $X \setminus \{x\}$, $x \in X$. Prove \mathcal{S} is a subbasis for the finite-closed topology on X .
8. Let X be any infinite set and \mathcal{T} the discrete topology on X . Find a subbasis \mathcal{S} for \mathcal{T} such that \mathcal{S} does not contain any singleton sets.
9. Let \mathcal{S} be the collection of all straight lines in the plane \mathbb{R}^2 . If \mathcal{S} is a subbasis for a topology \mathcal{T} on the set \mathbb{R}^2 , what is the topology?
10. Let \mathcal{S} be the collection of all straight lines in the plane which are parallel to the X -axis. If \mathcal{S} is a subbasis for a topology \mathcal{T} on \mathbb{R}^2 , describe the open sets in $(\mathbb{R}^2, \mathcal{T})$.
11. Let \mathcal{S} be the collection of all circles in the plane. If \mathcal{S} is a subbasis for a topology \mathcal{T} on \mathbb{R}^2 , describe the open sets in $(\mathbb{R}^2, \mathcal{T})$.
12. Let \mathcal{S} be the collection of all circles in the plane which have their centres on the X -axis. If \mathcal{S} is a subbasis for a topology \mathcal{T} on \mathbb{R}^2 , describe the open sets in $(\mathbb{R}^2, \mathcal{T})$.

2.4 Postscript

In this chapter we have defined a very important topological space – \mathbb{R} , the set of all real numbers with the euclidean topology, and spent some time analyzing it. We observed that, in this topology, open intervals are indeed open sets (and closed intervals are closed sets). However, not all open sets are open intervals. Nevertheless, every open set in \mathbb{R} is a union of open intervals. This led us to introduce the notion of “basis for a topology” and to establish that the collection of all open intervals is a basis for the euclidean topology on \mathbb{R} .

In the introduction to Chapter 1 we described a mathematical proof as a watertight argument and underlined the importance of writing proofs. In this chapter we were introduced to proof by contradiction in Remarks 2.1.2 (v) with another example in Example 2.2.7. Proving “necessary and sufficient” conditions, that is, “if and only if” conditions, was explained in Proposition 2.2.1, with further examples in Propositions 2.2.8, 2.3.2, 2.3.3, and 2.3.4.

Bases for topologies is a significant topic in its own right. We saw, for example, that the collection of all singletons is a basis for the discrete topology. Proposition 2.2.8 gives necessary and sufficient conditions for a collection of subsets of a set X to be a basis for some topology on X . This was contrasted with Proposition 2.3.2 which gives necessary and sufficient conditions for a collection of subsets of X to be a basis for the given topology on X . It was noted that two different collections \mathcal{B}_1 and \mathcal{B}_2 can be bases for the same topology. Necessary and sufficient conditions for this are given by Proposition 2.3.4.

We defined the euclidean topology on \mathbb{R}^n , for n any positive integer. We saw that the family of all open discs is a basis for \mathbb{R}^2 , as is the family of all open squares, or the family of all open rectangles.

The exercises introduced three interesting ideas. Exercises 2.1 #8 covered the notions of F_σ -set and G_δ -set which are important in measure theory. Exercises 2.3 #4 introduced the space of continuous real-valued functions. Such spaces are called function spaces which are the central objects of study in functional analysis. Functional analysis is a blend of (classical) analysis and topology, and was for some time called modern analysis, cf. Simmons [196]. Finally, Exercises 2.3 #5–12 dealt with the notion of subbasis.

Chapter 3

Limit Points

Introduction

On the real number line we have a notion of “closeness”. For example each point in the sequence $.1, .01, .001, .0001, .00001, \dots$ is closer to 0 than the previous one. Indeed, in some sense, 0 is a limit point of this sequence. So the interval $(0, 1]$ is not closed, as it does not contain the limit point 0. In a general topological space we do not have a “distance function”, so we must proceed differently. We shall define the notion of limit point without resorting to distances. Even with our new definition of limit point, the point 0 will still be a limit point of $(0, 1]$. The introduction of the notion of limit point will lead us to a much better understanding of the notion of closed set.

Another very important topological concept we shall introduce in this chapter is that of connectedness. Consider the topological space \mathbb{R} . While the sets $[0, 1] \cup [2, 3]$ and $[4, 6]$ could both be described as having length 2, it is clear that they are different types of sets ... the first consists of two disjoint pieces and the second of just one piece. The difference between the two is “topological” and will be exposed using the notion of connectedness.

3.1 Limit Points and Closure

If (X, \mathcal{T}) is a topological space then it is usual to refer to the elements of the set X as **points**.

3.1.1 Definition. Let A be a subset of a topological space (X, \mathcal{T}) . A point $x \in X$ is said to be a **limit point** (or **accumulation point** or **cluster point**) of A if every open set, U , containing x contains a point of A different from x .

3.1.2 Example. Consider the topological space (X, \mathcal{T}) where the set $X = \{a, b, c, d, e\}$, the topology $\mathcal{T} = \{X, \emptyset, \{a\}, \{c, d\}, \{a, c, d\}, \{b, c, d, e\}\}$, and $A = \{a, b, c\}$. Then $b, d,$ and e are limit points of A but a and c are not limit points of A .

Proof.

The point a is a limit point of A if and only if every open set containing a contains another point of the set A .

So to show that a is **not** a limit point of A , it suffices to find even one open set which contains a but contains no other point of A .

The set $\{a\}$ is open and contains no other point of A . So a is not a limit point of A .

The set $\{c, d\}$ is an open set containing c but no other point of A . So c is not a limit point of A .

To show that b is a limit point of A , we have to show that every open set containing b contains a point of A other than b .

We shall show this is the case by writing down **all** of the open sets containing b and verifying that each contains a point of A other than b .

The only open sets containing b are X and $\{b, c, d, e\}$ and both contain another element of A , namely c . So b is a limit point of A .

The point d is a limit point of A , even though it is not in A . This is so since every open set containing d contains a point of A . Similarly e is a limit point of A even though it is not in A . \square

3.1.3 Example. Let (X, \mathcal{T}) be a discrete space and A a subset of X . Then A has no limit points, since for each $x \in X$, $\{x\}$ is an open set containing no point of A different from x . \square

3.1.4 Example. Consider the subset $A = [a, b)$ of \mathbb{R} . Then it is easily verified that every element in $[a, b)$ is a limit point of A . The point b is also a limit point of A . \square

3.1.5 Example. Let (X, \mathcal{T}) be an indiscrete space and A a subset of X with at least two elements. Then it is readily seen that every point of X is a limit point of A . (Why did we insist that A have at least two points?) \square

The next proposition provides a useful way of testing whether a set is closed or not.

3.1.6 Proposition. Let A be a subset of a topological space (X, \mathcal{T}) . Then A is closed in (X, \mathcal{T}) if and only if A contains all of its limit points.

Proof.

We are required to prove that A is closed in (X, \mathcal{T}) if and only if A contains all of its limit points; that is, we have to show that

- (i) if A is a closed set, then it contains all of its limit points, and
- (ii) if A contains all of its limit points, then it is a closed set.

Assume that A is closed in (X, \mathcal{T}) . Suppose that p is a limit point of A which belongs to $X \setminus A$. Then $X \setminus A$ is an open set containing the limit point p of A . Therefore $X \setminus A$ contains an element of A . This is clearly false and so we have a contradiction to our supposition. Therefore every limit point of A must belong to A .

Conversely, assume that A contains all of its limit points. For each $z \in X \setminus A$, our assumption implies that there exists an open set $U_z \ni z$ such that $U_z \cap A = \emptyset$; that is, $U_z \subseteq X \setminus A$. Therefore $X \setminus A = \bigcup_{z \in X \setminus A} U_z$. (Check this!) So $X \setminus A$ is a union of open sets and hence is open. Consequently its complement, A , is closed. \square

3.1.7 Example. As applications of Proposition 3.1.6 we have the following:

- (i) the set $[a, b)$ is not closed in \mathbb{R} , since b is a limit point and $b \notin [a, b)$;
- (ii) the set $[a, b]$ is closed in \mathbb{R} , since all the limit points of $[a, b]$ (namely all the elements of $[a, b]$) are in $[a, b]$;
- (iii) (a, b) is not a closed subset of \mathbb{R} , since it does not contain the limit point a ;
- (iv) $[a, \infty)$ is a closed subset of \mathbb{R} . □

3.1.8 Proposition. Let A be a subset of a topological space (X, \mathcal{T}) and A' the set of all limit points of A . Then $A \cup A'$ is a closed set.

Proof. From Proposition 3.1.6 it suffices to show that the set $A \cup A'$ contains all of its limit points or equivalently that no element of $X \setminus (A \cup A')$ is a limit point of $A \cup A'$.

Let $p \in X \setminus (A \cup A')$. As $p \notin A'$, there exists an open set U containing p with $U \cap A = \{p\}$ or \emptyset . But $p \notin A$, so $U \cap A = \emptyset$. We claim also that $U \cap A' = \emptyset$. For if $x \in U$ then as U is an open set and $U \cap A = \emptyset$, $x \notin A'$. Thus $U \cap A' = \emptyset$. That is, $U \cap (A \cup A') = \emptyset$, and $p \in U$. This implies p is not a limit point of $A \cup A'$ and so $A \cup A'$ is a closed set. □

3.1.9 Definition. Let A be a subset of a topological space (X, \mathcal{T}) . Then the set $A \cup A'$ consisting of A and all its limit points is called the **closure of A** and is denoted by \overline{A} .

3.1.10 Remark. It is clear from Proposition 3.1.8 that \overline{A} is a closed set. By Proposition 3.1.6 and Exercises 3.1 #5 (i), every closed set containing A must also contain the set A' . So $A \cup A' = \overline{A}$ is the smallest closed set containing A . This implies that \overline{A} is the intersection of all closed sets containing A . □

3.1.11 Example. Let $X = \{a, b, c, d, e\}$ and

$$\mathcal{T} = \{X, \emptyset, \{a\}, \{c, d\}, \{a, c, d\}, \{b, c, d, e\}\}.$$

Show that $\overline{\{b\}} = \{b, e\}$, $\overline{\{a, c\}} = X$, and $\overline{\{b, d\}} = \{b, c, d, e\}$.

Proof.

To find the closure of a particular set, we shall find all the closed sets containing that set and then select the smallest. We therefore begin by writing down all of the closed sets – these are simply the complements of all the open sets.

The closed sets are $\emptyset, X, \{b, c, d, e\}, \{a, b, e\}, \{b, e\}$ and $\{a\}$. So the smallest closed set containing $\{b\}$ is $\{b, e\}$; that is, $\overline{\{b\}} = \{b, e\}$. Similarly $\overline{\{a, c\}} = X$, and $\overline{\{b, d\}} = \{b, c, d, e\}$. \square

3.1.12 Example. Let \mathbb{Q} be the subset of \mathbb{R} consisting of all the rational numbers. Prove that $\overline{\mathbb{Q}} = \mathbb{R}$.

Proof. Suppose $\overline{\mathbb{Q}} \neq \mathbb{R}$. Then there exists an $x \in \mathbb{R} \setminus \overline{\mathbb{Q}}$. As $\mathbb{R} \setminus \overline{\mathbb{Q}}$ is open in \mathbb{R} , there exist a, b with $a < b$ such that $x \in (a, b) \subseteq \mathbb{R} \setminus \overline{\mathbb{Q}}$. But in every interval (a, b) there is a rational number q ; that is, $q \in (a, b)$. So $q \in \mathbb{R} \setminus \overline{\mathbb{Q}}$ which implies $q \in \mathbb{R} \setminus \mathbb{Q}$. This is a contradiction, as $q \in \mathbb{Q}$. Hence $\overline{\mathbb{Q}} = \mathbb{R}$. \square

3.1.13 Definition. Let A be a subset of a topological space (X, \mathcal{T}) . Then A is said to be **dense** in X or **everywhere dense** in X if $\overline{A} = X$.

We can now restate Example 3.1.12 as: \mathbb{Q} is a dense subset of \mathbb{R} .

Note that in Example 3.1.11 we saw that $\{a, c\}$ is dense in X .

3.1.14 Example. Let (X, \mathcal{T}) be a discrete space. Then every subset of X is closed (since its complement is open). Therefore the only dense subset of X is X itself, since each subset of X is its own closure. \square

3.1.15 Proposition. Let A be a subset of a topological space (X, \mathcal{T}) . Then A is dense in X if and only if every non-empty open subset of X intersects A non-trivially (that is, if $U \in \mathcal{T}$ and $U \neq \emptyset$ then $A \cap U \neq \emptyset$.)

Proof. Assume, firstly that every non-empty open set intersects A non-trivially. If $A = X$, then clearly A is dense in X . If $A \neq X$, let $x \in X \setminus A$. If $U \in \mathcal{T}$ and $x \in U$ then $U \cap A \neq \emptyset$. So x is a limit point of A . As x is an arbitrary point in $X \setminus A$, every point of $X \setminus A$ is a limit point of A . So $A' \supseteq X \setminus A$ and then, by Definition 3.1.9, $\overline{A} = A' \cup A = X$; that is, A is dense in X .

Conversely, assume A is dense in X . Let U be any non-empty open subset of X . Suppose $U \cap A = \emptyset$. Then if $x \in U$, $x \notin A$ and x is not a limit point of A , since U is an open set containing x which does not contain any element of A . This is a contradiction since, as A is dense in X , every element of $X \setminus A$ is a limit point of A . So our supposition is false and $U \cap A \neq \emptyset$, as required. □

Exercises 3.1

1. (a) In Example 1.1.2, find all the limit points of the following sets:
 - (i) $\{a\}$,
 - (ii) $\{b, c\}$,
 - (iii) $\{a, c, d\}$,
 - (iv) $\{b, d, e, f\}$.

(b) Hence, find the closure of each of the above sets.

(c) Now find the closure of each of the above sets using the method of Example 3.1.11.
2. Let $(\mathbb{Z}, \mathcal{T})$ be the set of integers with the finite-closed topology. List the set of limit points of the following sets:
 - (i) $A = \{1, 2, 3, \dots, 10\}$,
 - (ii) The set, E , consisting of all even integers.

3. Find all the limit points of the open interval (a, b) in \mathbb{R} , where $a < b$.
4. (a) What is the closure in \mathbb{R} of each of the following sets?
- (i) $\{1, \frac{1}{2}, \frac{1}{3}, \frac{1}{4}, \dots, \frac{1}{n}, \dots\}$,
 - (ii) the set \mathbb{Z} of all integers,
 - (iii) the set \mathbb{P} of all irrational numbers.
- (b) Let S be a subset of \mathbb{R} and $a \in \mathbb{R}$. Prove that $a \in \overline{S}$ if and only if for each positive integer n , there exists an $x_n \in S$ such that $|x_n - a| < \frac{1}{n}$.
5. Let S and T be non-empty subsets of a topological space (X, \mathcal{T}) with $S \subseteq T$.
- (i) If p is a limit point of the set S , verify that p is also a limit point of the set T .
 - (ii) Deduce from (i) that $\overline{S} \subseteq \overline{T}$.
 - (iii) Hence show that if S is dense in X , then T is dense in X .
 - (iv) Using (iii) show that \mathbb{R} has an uncountable number of distinct dense subsets.
 - (v)* Again using (iii), prove that \mathbb{R} has an uncountable number of distinct countable dense subsets and $2^{\mathfrak{c}}$ distinct uncountable dense subsets.

3.2 Neighbourhoods

3.2.1 Definition. Let (X, \mathcal{T}) be a topological space, N a subset of X and p a point in N . Then N is said to be a **neighbourhood** of the point p if there exists an open set U such that $p \in U \subseteq N$.

3.2.2 Example. The closed interval $[0, 1]$ in \mathbb{R} is a neighbourhood of the point $\frac{1}{2}$, since $\frac{1}{2} \in (\frac{1}{4}, \frac{3}{4}) \subseteq [0, 1]$. □

3.2.3 Example. The interval $(0, 1]$ in \mathbb{R} is a neighbourhood of the point $\frac{1}{4}$, as $\frac{1}{4} \in (0, \frac{1}{2}) \subseteq (0, 1]$. But $(0, 1]$ is not a neighbourhood of the point 1. (Prove this.) □

3.2.4 Example. If (X, \mathcal{T}) is any topological space and $U \in \mathcal{T}$, then from Definition 3.2.1, it follows that U is a neighbourhood of every point $p \in U$. So, for example, every open interval (a, b) in \mathbb{R} is a neighbourhood of every point that it contains. \square

3.2.5 Example. Let (X, \mathcal{T}) be a topological space, and N a neighbourhood of a point p . If S is any subset of X such that $N \subseteq S$, then S is a neighbourhood of p . \square

The next proposition is easily verified, so its proof is left to the reader.

3.2.6 Proposition. Let A be a subset of a topological space (X, \mathcal{T}) . A point $x \in X$ is a limit point of A if and only if every neighbourhood of x contains a point of A different from x . \square

As a set is closed if and only if it contains all its limit points we deduce the following:

3.2.7 Corollary. Let A be a subset of a topological space (X, \mathcal{T}) . Then the set A is closed if and only if for each $x \in X \setminus A$ there is a neighbourhood N of x such that $N \subseteq X \setminus A$. \square

3.2.8 Corollary. Let U be a subset of a topological space (X, \mathcal{T}) . Then $U \in \mathcal{T}$ if and only if for each $x \in U$ there exists a neighbourhood N of x such that $N \subseteq U$. \square

The next corollary is readily deduced from Corollary 3.2.8.

3.2.9 Corollary. Let U be a subset of a topological space (X, \mathcal{T}) . Then $U \in \mathcal{T}$ if and only if for each $x \in U$ there exists a $V \in \mathcal{T}$ such that $x \in V \subseteq U$. \square

Corollary 3.2.9 provides a useful test of whether a set is open or not. It says that a set is open if and only if it contains an open set about each of its points.

Exercises 3.2

1. Let A be a subset of a topological space (X, \mathcal{T}) . Prove that A is dense in X if and only if every neighbourhood of each point in $X \setminus A$ intersects A non-trivially.

2. (i) Let A and B be subsets of a topological space (X, \mathcal{T}) . Prove carefully that

$$\overline{A \cap B} \subseteq \overline{A} \cap \overline{B}.$$

(ii) Construct an example in which

$$\overline{A \cap B} \neq \overline{A} \cap \overline{B}.$$

3. Let (X, \mathcal{T}) be a topological space. Prove that \mathcal{T} is the finite-closed topology on X if and only if (i) (X, \mathcal{T}) is a T_1 -space, and (ii) every infinite subset of X is dense in X .

4. A topological space (X, \mathcal{T}) is said to be **separable** if it has a dense subset which is countable. Determine which of the following spaces are separable:

(i) the set \mathbb{R} with the usual topology;

(ii) a countable set with the discrete topology;

(iii) a countable set with the finite-closed topology;

(iv) (X, \mathcal{T}) where X is finite;

(v) (X, \mathcal{T}) where \mathcal{T} is finite;

(vi) an uncountable set with the discrete topology;

(vii) an uncountable set with the finite-closed topology;

(viii) a space (X, \mathcal{T}) satisfying the second axiom of countability.

5. Let (X, \mathcal{T}) be any topological space and A any subset of X . The largest open set contained in A is called the **interior of A** and is denoted by $\text{Int}(A)$. [It is the union of all open sets in X which lie wholly in A .]
- (i) Prove that in \mathbb{R} , $\text{Int}([0, 1]) = (0, 1)$.
 - (ii) Prove that in \mathbb{R} , $\text{Int}((3, 4)) = (3, 4)$.
 - (iii) Show that if A is open in (X, \mathcal{T}) then $\text{Int}(A) = A$.
 - (iv) Verify that in \mathbb{R} , $\text{Int}(\{3\}) = \emptyset$.
 - (v) Show that if (X, \mathcal{T}) is an indiscrete space then, for all proper subsets A of X , $\text{Int}(A) = \emptyset$.
 - (vi) Show that for every countable subset A of \mathbb{R} , $\text{Int}(A) = \emptyset$.
6. Show that if A is any subset of a topological space (X, \mathcal{T}) , then $\text{Int}(A) = X \setminus \overline{(X \setminus A)}$. (See Exercise 5 above for the definition of Int .)
7. Using Exercise 6 above, verify that A is dense in (X, \mathcal{T}) if and only if $\text{Int}(X \setminus A) = \emptyset$.
8. Using the definition of Int in Exercise 5 above, determine which of the following statements are true for arbitrary subsets A_1 and A_2 of a topological space (X, \mathcal{T}) ?
- (i) $\text{Int}(A_1 \cap A_2) = \text{Int}(A_1) \cap \text{Int}(A_2)$,
 - (ii) $\text{Int}(A_1 \cup A_2) = \text{Int}(A_1) \cup \text{Int}(A_2)$,
 - (iii) $\overline{A_1 \cup A_2} = \overline{A_1} \cup \overline{A_2}$.
- (If your answer to any part is “true” you must write a proof. If your answer is “false” you must give a concrete counterexample.)
- 9.* Let S be a dense subset of a topological space (X, \mathcal{T}) . Prove that for every open subset U of X , $\overline{S \cap U} = \overline{U}$.
10. Let S and T be dense subsets of a space (X, \mathcal{T}) . If T is also open, deduce from Exercise 9 above that $S \cap T$ is dense in X .

11. Let $\mathcal{B} = \{[a, b) : a \in \mathbb{R}, b \in \mathbb{Q}, a < b\}$. Prove each of the following statements.
- (i) \mathcal{B} is a basis for a topology \mathcal{T}_1 on \mathbb{R} . (The space $(\mathbb{R}, \mathcal{T}_1)$ is called the **Sorgenfrey line**.)
 - (ii) If \mathcal{T} is the Euclidean topology on \mathbb{R} , then $\mathcal{T}_1 \supset \mathcal{T}$.
 - (iii) For all $a, b \in \mathbb{R}$ with $a < b$, $[a, b)$ is a clopen set in $(\mathbb{R}, \mathcal{T}_1)$.
 - (iv) The Sorgenfrey line is a separable space.
 - (v)* The Sorgenfrey line does not satisfy the second axiom of countability.

3.3 Connectedness

3.3.1 Remark. We record here some definitions and facts you should already know. Let S be any set of real numbers. If there is an element b in S such that $x \leq b$, for all $x \in S$, then b is said to be **the greatest element** of S . Similarly if S contains an element a such that $a \leq x$, for all $x \in S$, then a is called **the least element** of S . A set S of real numbers is said to be **bounded above** if there exists a real number c such that $x \leq c$, for all $x \in S$, and c is called an **upper bound** for S . Similarly the terms “**bounded below**” and “**lower bound**” are defined. A set which is bounded above and bounded below is said to be **bounded**. □

Least Upper Bound Axiom: Let S be a non-empty set of real numbers. If S is bounded above, then it has a least upper bound. □

The least upper bound, also called the **supremum** of S , denoted by $\sup(S)$, may or may not belong to the set S . Indeed, the supremum of S is an element of S if and only if S has a greatest element. For example, the supremum of the open interval $S = (1, 2)$ is 2 but $2 \notin (1, 2)$, while the supremum of $[3, 4]$ is 4 which does lie in $[3, 4]$ and 4 is the greatest element of $[3, 4]$. Any set S of real numbers which is bounded below has a **greatest lower bound** which is also called the **infimum** and is denoted by $\inf(S)$.

3.3.2 Lemma. Let S be a subset of \mathbb{R} which is bounded above and let p be the supremum of S . If S is a closed subset of \mathbb{R} , then $p \in S$.

Proof. Suppose $p \in \mathbb{R} \setminus S$. As $\mathbb{R} \setminus S$ is open there exist real numbers a and b with $a < b$ such that $p \in (a, b) \subseteq \mathbb{R} \setminus S$. As p is the least upper bound for S and $a < p$, it is clear that there exists an $x \in S$ such that $a < x$. Also $x < p < b$, and so $x \in (a, b) \subseteq \mathbb{R} \setminus S$. But this is a contradiction, since $x \in S$. Hence our supposition is false and $p \in S$. \square

3.3.3 Proposition. Let T be a clopen subset of \mathbb{R} . Then either $T = \mathbb{R}$ or $T = \emptyset$.

Proof. Suppose $T \neq \mathbb{R}$ and $T \neq \emptyset$. Then there exists an element $x \in T$ and an element $z \in \mathbb{R} \setminus T$. Without loss of generality, assume $x < z$. Put $S = T \cap [x, z]$. Then S , being the intersection of two closed sets, is closed. It is also bounded above, since z is obviously an upper bound. Let p be the supremum of S . By Lemma 3.3.2, $p \in S$. Since $p \in [x, z]$, $p \leq z$. As $z \in \mathbb{R} \setminus S$, $p \neq z$ and so $p < z$.

Now T is also an open set and $p \in T$. So there exist a and b in \mathbb{R} with $a < b$ such that $p \in (a, b) \subseteq T$. Let t be such that $p < t < \min(b, z)$, where $\min(b, z)$ denotes the smaller of b and z . So $t \in T$ and $t \in [p, z]$. Thus $t \in T \cap [x, z] = S$. This is a contradiction since $t > p$ and p is the supremum of S . Hence our supposition is false and consequently $T = \mathbb{R}$ or $T = \emptyset$. \square

3.3.4 Definition. Let (X, \mathcal{T}) be a topological space. Then it is said to be **connected** if the only clopen subsets of X are X and \emptyset .

So restating Proposition 3.3.3 we obtain:

3.3.5 Proposition. The topological space \mathbb{R} is connected. \square

3.3.6 Example. If (X, \mathcal{T}) is any discrete space with more than one element, then (X, \mathcal{T}) is not connected as each singleton set is clopen. \square

3.3.7 Example. If (X, \mathcal{T}) is any indiscrete space, then it is connected as the only clopen sets are X and \emptyset . (Indeed the only open sets are X and \emptyset .) \square

3.3.8 Example. If $X = \{a, b, c, d, e\}$ and

$$\mathcal{T} = \{X, \emptyset, \{a\}, \{c, d\}, \{a, c, d\}, \{b, c, d, e\}\},$$

then (X, \mathcal{T}) is not connected as $\{b, c, d, e\}$ is a clopen subset. \square

3.3.9 Remark. From Definition 3.3.4 it follows that a topological space (X, \mathcal{T}) is not connected (that is, it is **disconnected**) if and only if there are non-empty open sets A and B such that $A \cap B = \emptyset$ and $A \cup B = X$.¹ (See Exercises 3.3 #3.)

We conclude this section by recording that \mathbb{R}^2 (and indeed, \mathbb{R}^n , for each $n \geq 1$) is a connected space. However the proof is delayed to Chapter 5.

Connectedness is a very important property about which we shall say a lot more.

Exercises 3.3

1. Let S be a set of real numbers and $T = \{x : -x \in S\}$.
 - (a) Prove that the real number a is the infimum of S if and only if $-a$ is the supremum of T .
 - (b) Using (a) and the Least Upper Bound Axiom prove that every non-empty set of real numbers which is bounded below has a greatest lower bound.

¹Most books use this property to define connectedness.

2. For each of the following sets of real numbers find the greatest element and the least upper bound, if they exist.
 - (i) $S = \mathbb{R}$.
 - (ii) $S = \mathbb{Z} =$ the set of all integers.
 - (iii) $S = [9, 10)$.
 - (iv) $S =$ the set of all real numbers of the form $1 - \frac{3}{n^2}$, where n is a positive integer.
 - (v) $S = (-\infty, 3]$.
3. Let (X, \mathcal{T}) be any topological space. Prove that (X, \mathcal{T}) is not connected if and only if it has proper non-empty disjoint open subsets A and B such that $A \cup B = X$.
4. Is the space (X, \mathcal{T}) of Example 1.1.2 connected?
5. Let (X, \mathcal{T}) be any infinite set with the finite-closed topology. Is (X, \mathcal{T}) connected?
6. Let (X, \mathcal{T}) be an infinite set with the countable-closed topology. Is (X, \mathcal{T}) connected?
7. Which of the topological spaces of Exercises 1.1 #9 are connected?

3.4 Postscript

In this chapter we have introduced the notion of limit point and shown that a set is closed if and only if it contains all its limit points. Proposition 3.1.8 then tells us that any set A has a smallest closed set \bar{A} which contains it. The set \bar{A} is called the closure of A .

A subset A of a topological space (X, \mathcal{T}) is said to be dense in X if $\bar{A} = X$. We saw that \mathbb{Q} is dense in \mathbb{R} and the set \mathbb{P} of all irrational numbers is also dense in \mathbb{R} . We introduced the notion of neighbourhood of a point and the notion of connected topological space. We proved an important result, namely that \mathbb{R} is connected. We shall have much more to say about connectedness later.

In the exercises we introduced the notion of interior of a set, this being complementary to that of closure of a set.

Chapter 4

Homeomorphisms

Introduction

In each branch of mathematics it is essential to recognize when two structures are equivalent. For example two sets are equivalent, as far as set theory is concerned, if there exists a bijective function which maps one set onto the other. Two groups are equivalent, known as isomorphic, if there exists a homomorphism of one to the other which is one-to-one and onto. Two topological spaces are equivalent, known as homeomorphic, if there exists a homeomorphism of one onto the other.

4.1 Subspaces

4.1.1 Definition. Let Y be a non-empty subset of a topological space (X, \mathcal{T}) . The collection $\mathcal{T}_Y = \{O \cap Y : O \in \mathcal{T}\}$ of subsets of Y is a topology on Y called the **subspace topology** (or the **relative topology** or the **induced topology** or the **topology induced on Y by \mathcal{T}**). The topological space (Y, \mathcal{T}_Y) is said to be a **subspace** of (X, \mathcal{T}) .

Of course you should check that \mathcal{T}_Y is indeed a topology on Y .

4.1.2 Example. Let $X = \{a, b, c, d, e, f\}$,

$$\mathcal{T} = \{X, \emptyset, \{a\}, \{c, d\}, \{a, c, d\}, \{b, c, d, e, f\}\}$$

, and $Y = \{b, c, e\}$. Then the subspace topology on Y is

$$\mathcal{T}_Y = \{Y, \emptyset, \{c\}\}.$$

□

4.1.3 Example. Let $X = \{a, b, c, d, e\}$,

$$\mathcal{T} = \{X, \emptyset, \{a\}, \{c, d\}, \{a, c, d\}, \{b, c, d, e\}\},$$

and $Y = \{a, d, e\}$. Then the induced topology on Y is

$$\mathcal{T}_Y = \{Y, \emptyset, \{a\}, \{d\}, \{a, d\}, \{d, e\}\}.$$

□

4.1.4 Example. Let \mathcal{B} be a basis for the topology \mathcal{T} on X and let Y be a subset of X . Then it is not hard to show that the collection $\mathcal{B}_Y = \{B \cap Y : B \in \mathcal{B}\}$ is a basis for the subspace topology \mathcal{T}_Y on Y . [Exercise: verify this.]

So let us consider the subset $(1, 2)$ of \mathbb{R} . A basis for the induced topology on $(1, 2)$ is the collection $\{(a, b) \cap (1, 2) : a, b \in \mathbb{R}, a < b\}$; that is, $\{(a, b) : a, b \in \mathbb{R}, 1 \leq a < b \leq 2\}$ is a basis for the induced topology on $(1, 2)$. □

4.1.5 Example. Consider the subset $[1, 2]$ of \mathbb{R} . A basis for the subspace topology \mathcal{T} on $[1, 2]$ is

$$\{(a, b) \cap [1, 2] : a, b \in \mathbb{R}, a < b\};$$

that is,

$$\{(a, b) : 1 \leq a < b \leq 2\} \cup \{[1, b) : 1 < b \leq 2\} \cup \{(a, 2] : 1 \leq a < 2\} \cup \{[1, 2]\}$$

is a basis for \mathcal{T} .

But here we see some surprising things happening; e.g. $[1, 1\frac{1}{2})$ is certainly not an open set in \mathbb{R} , but $[1, 1\frac{1}{2}) = (0, 1\frac{1}{2}) \cap [1, 2]$, is an open set in the subspace $[1, 2]$.

Also $(1, 2]$ is not open in \mathbb{R} but is open in $[1, 2]$. Even $[1, 2]$ is not open in \mathbb{R} , but is an open set in $[1, 2]$.

So whenever we speak of a set being open we must make perfectly clear in what space or what topology it is an open set. □

4.1.6 Example. Let \mathbb{Z} be the subset of \mathbb{R} consisting of all the integers. Prove that the topology induced on \mathbb{Z} by the euclidean topology on \mathbb{R} is the discrete topology.

Proof.

To prove that the induced topology, $\tau_{\mathbb{Z}}$, on \mathbb{Z} is discrete, it suffices, by Proposition 1.1.9, to show that every singleton set in \mathbb{Z} is open in $\tau_{\mathbb{Z}}$; that is, if $n \in \mathbb{Z}$ then $\{n\} \in \tau_{\mathbb{Z}}$.

Let $n \in \mathbb{Z}$. Then $\{n\} = (n-1, n+1) \cap \mathbb{Z}$. But $(n-1, n+1)$ is open in \mathbb{R} and therefore $\{n\}$ is open in the induced topology on \mathbb{Z} . Thus every singleton set in \mathbb{Z} is open in the induced topology on \mathbb{Z} . So the induced topology is discrete. \square

Notation. Whenever we refer to

\mathbb{Q} = the set of all rational numbers,

\mathbb{Z} = the set of all integers,

\mathbb{N} = the set of all positive integers,

\mathbb{P} = the set of all irrational numbers,

(a, b) , $[a, b]$, $[a, b)$, $(-\infty, a)$, $(-\infty, a]$, (a, ∞) , or $[a, \infty)$

as topological spaces without explicitly saying what the topology is, we mean the topology induced as a subspace of \mathbb{R} . (Sometimes we shall refer to the induced topology on these sets as the “**usual topology**”.)

Exercises 4.1

- Let $X = \{a, b, c, d, e\}$ and $\mathcal{T} = \{X, \emptyset, \{a\}, \{a, b\}, \{a, c, d\}, \{a, b, c, d\}, \{a, b, e\}\}$. List the members of the induced topologies τ_Y on $Y = \{a, c, e\}$ and τ_Z on $Z = \{b, c, d, e\}$.

2. Describe the topology induced on the set \mathbb{N} of positive integers by the euclidean topology on \mathbb{R} .
3. Write down a basis for the usual topology on each of the following:
 - (i) $[a, b)$, where $a < b$;
 - (ii) $(a, b]$, where $a < b$;
 - (iii) $(-\infty, a]$;
 - (iv) $(-\infty, a)$;
 - (v) (a, ∞) ;
 - (vi) $[a, \infty)$.

[Hint: see Examples 4.1.4 and 4.1.5.]

4. Let $A \subseteq B \subseteq X$ and X have the topology \mathcal{T} . Let \mathcal{T}_B be the subspace topology on B . Further let \mathcal{T}_1 be the topology induced on A by \mathcal{T} , and \mathcal{T}_2 be the topology induced on A by \mathcal{T}_B . Prove that $\mathcal{T}_1 = \mathcal{T}_2$. (So a subspace of a subspace is a subspace.)
5. Let (Y, \mathcal{T}_Y) be a subspace of a space (X, \mathcal{T}) . Show that a subset Z of Y is closed in (Y, \mathcal{T}_Y) if and only if $Z = A \cap Y$, where A is a closed subset of (X, \mathcal{T}) .
6. Show that every subspace of a discrete space is discrete.
7. Show that every subspace of an indiscrete space is indiscrete.
8. Show that the subspace $[0, 1] \cup [3, 4]$ of \mathbb{R} has at least 4 clopen subsets. Exactly how many clopen subsets does it have?
9. Is it true that every subspace of a connected space is connected?
10. Let (Y, \mathcal{T}_Y) be a subspace of (X, \mathcal{T}) . Show that $\mathcal{T}_Y \subseteq \mathcal{T}$ if and only if $Y \in \mathcal{T}$.

[Hint: Remember $Y \in \mathcal{T}_Y$.]

11. Let A and B be connected subspaces of a topological space (X, \mathcal{T}) . If $A \cap B \neq \emptyset$, prove that the subspace $A \cup B$ is connected.

12. Let (Y, \mathcal{T}_1) be a subspace of a T_1 -space (X, \mathcal{T}) . Show that (Y, \mathcal{T}_1) is also a T_1 -space.
13. A topological space (X, \mathcal{T}) is said to be **Hausdorff** (or a **T_2 -space**) if given any pair of distinct points a, b in X there exist open sets U and V such that $a \in U$, $b \in V$, and $U \cap V = \emptyset$.
- (i) Show that \mathbb{R} is Hausdorff.
 - (ii) Prove that every discrete space is Hausdorff.
 - (iii) Show that any T_2 -space is also a T_1 -space.
 - (iv) Show that \mathbb{Z} with the finite-closed topology is a T_1 -space but is not a T_2 -space.
 - (v) Prove that any subspace of a T_2 -space is a T_2 -space.
14. Let (Y, \mathcal{T}_1) be a subspace of a topological space (X, \mathcal{T}) . If (X, \mathcal{T}) satisfies the second axiom of countability, show that (Y, \mathcal{T}_1) also satisfies the second axiom of countability.
15. Let a and b be in \mathbb{R} with $a < b$. Prove that $[a, b]$ is connected.
- [Hint: In the statement and proof of Proposition 3.3.3 replace \mathbb{R} everywhere by $[a, b]$.]
16. Let \mathbb{Q} be the set of all rational numbers with the usual topology and let \mathbb{P} be the set of all irrational numbers with the usual topology.
- (i) Prove that neither \mathbb{Q} nor \mathbb{P} is a discrete space.
 - (ii) Is \mathbb{Q} or \mathbb{P} a connected space?
 - (iii) Is \mathbb{Q} or \mathbb{P} a Hausdorff space?
 - (iv) Does \mathbb{Q} or \mathbb{P} have the finite-closed topology?
17. A topological space (X, \mathcal{T}) is said to be a **regular space** if for any closed subset A of X and any point $x \in X \setminus A$, there exist open sets U and V such that $x \in U$, $A \subseteq V$, and $U \cap V = \emptyset$. If (X, \mathcal{T}) is regular and a T_1 -space, then it is said to be a **T_3 -space**. Prove the following statements.
- (i) Every subspace of a regular space is a regular space.
 - (ii) The spaces \mathbb{R} , \mathbb{Z} , \mathbb{Q} , \mathbb{P} , and \mathbb{R}^2 are regular spaces.
 - (iii) If (X, \mathcal{T}) is a regular T_1 -space, then it is a T_2 -space.

(iv) The Sorgenfrey line is a regular space.

(v)* Let X be the set, \mathbb{R} , of all real numbers and $S = \{\frac{1}{n} : n \in \mathbb{N}\}$. Define a set $C \subseteq \mathbb{R}$ to be closed if $C = A \cup T$, where A is closed in the euclidean topology on \mathbb{R} and T is any subset of S . The complements of these closed sets form a topology \mathcal{T} on \mathbb{R} which is Hausdorff but not regular.

4.2 Homeomorphisms

We now turn to the notion of equivalent topological spaces. We begin by considering an example:

$$X = \{a, b, c, d, e\}, \quad Y = \{g, h, i, j, k\},$$

$$\mathcal{T} = \{X, \emptyset, \{a\}, \{c, d\}, \{a, c, d\}, \{b, c, d, e\}\},$$

and

$$\mathcal{T}_1 = \{Y, \emptyset, \{g\}, \{i, j\}, \{g, i, j\}, \{h, i, j, k\}\}.$$

It is clear that in an intuitive sense (X, \mathcal{T}) is “equivalent” to (Y, \mathcal{T}_1) . The function $f: X \rightarrow Y$ defined by $f(a) = g$, $f(b) = h$, $f(c) = i$, $f(d) = j$, and $f(e) = k$, provides the equivalence. We now formalize this.

4.2.1 Definition. Let (X, \mathcal{T}) and (Y, \mathcal{T}_1) be topological spaces. Then they are said to be **homeomorphic** if there exists a function $f: X \rightarrow Y$ which has the following properties:

- (i) f is one-to-one (that is $f(x_1) = f(x_2)$ implies $x_1 = x_2$),
- (ii) f is onto (that is, for any $y \in Y$ there exists an $x \in X$ such that $f(x) = y$),
- (iii) for each $U \in \mathcal{T}_1$, $f^{-1}(U) \in \mathcal{T}$, and
- (iv) for each $V \in \mathcal{T}$, $f(V) \in \mathcal{T}_1$.

Further, the map f is said to be a **homeomorphism** between (X, \mathcal{T}) and (Y, \mathcal{T}_1) . We write $(X, \mathcal{T}) \cong (Y, \mathcal{T}_1)$. □

We shall show that “ \cong ” is an equivalence relation and use this to show that all open intervals (a, b) are homeomorphic to each other. Example 4.2.2 is the first step, as it shows that “ \cong ” is a transitive relation.

4.2.2 Example. Let $(X, \mathcal{T}), (Y, \mathcal{T}_1)$ and (Z, \mathcal{T}_2) be topological spaces. If $(X, \mathcal{T}) \cong (Y, \mathcal{T}_1)$ and $(Y, \mathcal{T}_1) \cong (Z, \mathcal{T}_2)$, prove that $(X, \mathcal{T}) \cong (Z, \mathcal{T}_2)$.

Proof.

We are given that $(X, \mathcal{T}) \cong (Y, \mathcal{T}_1)$; that is, there exists a homeomorphism $f : (X, \mathcal{T}) \rightarrow (Y, \mathcal{T}_1)$. We are also given that $(Y, \mathcal{T}_1) \cong (Z, \mathcal{T}_2)$; that is, there exists a homeomorphism $g : (Y, \mathcal{T}_1) \rightarrow (Z, \mathcal{T}_2)$.

We are required to prove that $(X, \mathcal{T}) \cong (Z, \mathcal{T}_2)$; that is, we need to find a homeomorphism $h : (X, \mathcal{T}) \rightarrow (Z, \mathcal{T}_2)$. We will prove that the composite map $g \circ f : X \rightarrow Z$ is the required homeomorphism.

As $(X, \mathcal{T}) \cong (Y, \mathcal{T}_1)$ and $(Y, \mathcal{T}_1) \cong (Z, \mathcal{T}_2)$, there exist homeomorphisms $f : (X, \mathcal{T}) \rightarrow (Y, \mathcal{T}_1)$ and $g : (Y, \mathcal{T}_1) \rightarrow (Z, \mathcal{T}_2)$. Consider the composite map $g \circ f : X \rightarrow Z$. [Thus $g \circ f(x) = g(f(x))$, for all $x \in X$.] It is a routine task to verify that $g \circ f$ is one-to-one and onto. Now let $U \in \mathcal{T}_2$. Then, as g is a homeomorphism $g^{-1}(U) \in \mathcal{T}_1$. Using the fact that f is a homeomorphism we obtain that $f^{-1}(g^{-1}(U)) \in \mathcal{T}$. But $f^{-1}(g^{-1}(U)) = (g \circ f)^{-1}(U)$. So $g \circ f$ has property (iii) of Definition 4.2.1. Next let $V \in \mathcal{T}$. Then $f(V) \in \mathcal{T}_1$ and so $g(f(V)) \in \mathcal{T}_2$; that is $g \circ f(V) \in \mathcal{T}_2$ and we see that $g \circ f$ has property (iv) of Definition 4.2.1. Hence $g \circ f$ is a homeomorphism. \square

4.2.3 Remark. Example 4.2.2 shows that “ \cong ” is a transitive binary relation. Indeed it is easily verified that it is an equivalence relation; that is,

(i) $(X, \mathcal{T}) \cong (X, \mathcal{T})$ (Reflexive);

(ii) $(X, \mathcal{T}) \cong (Y, \mathcal{T}_1)$ implies $(Y, \mathcal{T}_1) \cong (X, \mathcal{T})$ (Symmetric);

[Observe that if $f : (X, \mathcal{T}) \rightarrow (Y, \mathcal{T}_1)$ is a homeomorphism, then its inverse $f^{-1} : (Y, \mathcal{T}_1) \rightarrow (X, \mathcal{T})$ is also a homeomorphism.]

(iii) $(X, \mathcal{T}) \cong (Y, \mathcal{T}_1)$ and $(Y, \mathcal{T}_1) \cong (Z, \mathcal{T}_2)$ implies $(X, \mathcal{T}) \cong (Z, \mathcal{T}_2)$ (Transitive).

□

The next three examples show that all open intervals in \mathbb{R} are homeomorphic. Length is certainly not a topological property. In particular, an open interval of finite length, such as $(0, 1)$, is homeomorphic to one of infinite length, such as $(-\infty, 1)$. Indeed all open intervals are homeomorphic to \mathbb{R} .

4.2.4 Example. Prove that any two non-empty open intervals (a, b) and (c, d) are homeomorphic.

Outline Proof.

By Remark 4.2.3 it suffices to show that (a, b) is homeomorphic to $(0, 1)$ and (c, d) is homeomorphic to $(0, 1)$. But as a and b are arbitrary (except that $a < b$), if (a, b) is homeomorphic to $(0, 1)$ then (c, d) is also homeomorphic to $(0, 1)$. To prove that (a, b) is homeomorphic to $(0, 1)$ it suffices to find a homeomorphism $f : (0, 1) \rightarrow (a, b)$.

Let $a, b \in \mathbb{R}$ with $a < b$ and consider the function $f : (0, 1) \rightarrow (a, b)$ given by

$$f(x) = a(1 - x) + bx.$$

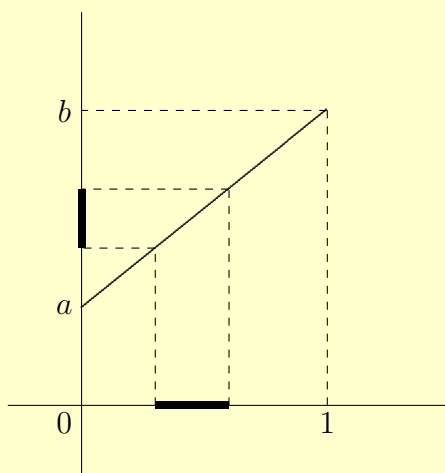

Clearly $f : (0, 1) \rightarrow (a, b)$ is one-to-one and onto. It is also clear from the diagram that the image under f of any open interval in $(0, 1)$ is an open interval in (a, b) ; that is,

$$f(\text{open interval in } (0, 1)) = \text{an open interval in } (a, b).$$

But every open set in $(0, 1)$ is a union of open intervals in $(0, 1)$ and so

$$\begin{aligned} f(\text{open set in } (0, 1)) &= f(\text{union of open intervals in } (0, 1)) \\ &= \text{union of open intervals in } (a, b) \\ &= \text{open set in } (a, b). \end{aligned}$$

So condition (iv) of Definition 4.2.1 is satisfied. Similarly, we see that f^{-1} (open set in (a, b)) is an open set in $(0, 1)$. So condition (iii) of Definition 4.2.1 is also satisfied.

[Exercise: write out the above proof carefully.]

Hence f is a homeomorphism and $(0, 1) \cong (a, b)$, for all $a, b \in \mathbb{R}$ with $a < b$.

From the above it immediately follows that $(a, b) \cong (c, d)$, as required. \square

4.2.5 Example. Prove that the space \mathbb{R} is homeomorphic to the open interval $(-1, 1)$ with the usual topology.

Outline Proof. Define $f : (-1, 1) \rightarrow \mathbb{R}$ by

$$f(x) = \frac{x}{1 - |x|}.$$

It is readily verified that f is one-to-one and onto, and a diagrammatic argument like that in Example 4.2.2 indicates that f is a homeomorphism.

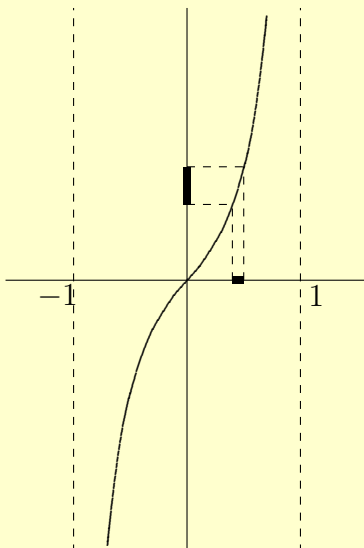

[Exercise: write out a proof that f is a homeomorphism.]

□

4.2.6 Example. Prove that every open interval (a, b) , with $a < b$, is homeomorphic to \mathbb{R} .

Proof. This follows immediately from Examples 4.2.5 and 4.2.4 and Remark 4.2.3.

□

4.2.7 Remark. It can be proved in a similar fashion that any two intervals $[a, b]$ and $[c, d]$, with $a < b$ and $c < d$, are homeomorphic.

□

Exercises 4.2

1. (i) If a, b, c , and d are real numbers with $a < b$ and $c < d$, prove that $[a, b] \cong [c, d]$.

(ii) If a and b are any real numbers, prove that

$$(-\infty, a] \cong (-\infty, b] \cong [a, \infty) \cong [b, \infty).$$

(iii) If c, d, e , and f are any real numbers with $c < d$ and $e < f$, prove that

$$[c, d] \cong [e, f] \cong (c, d] \cong (e, f].$$

(iv) Deduce that for any real numbers a and b with $a < b$,

$$[0, 1) \cong (-\infty, a] \cong [a, \infty) \cong [a, b) \cong (a, b].$$

2. Prove that $\mathbb{Z} \cong \mathbb{N}$

3. Let m and c be non-zero real numbers and X the subspace of \mathbb{R}^2 given by $X = \{\langle x, y \rangle : y = mx + c\}$. Prove that X is homeomorphic to \mathbb{R} .

4. (i) Let X_1 and X_2 be the closed rectangular regions in \mathbb{R}^2 given by

$$X_1 = \{\langle x, y \rangle : |x| \leq a_1 \text{ and } |y| \leq b_1\}$$

and

$$X_2 = \{\langle x, y \rangle : |x| \leq a_2 \text{ and } |y| \leq b_2\}$$

where a_1, b_1, a_2 , and b_2 are positive real numbers. If X_1 and X_2 are given the induced topologies from \mathbb{R}^2 , show that $X_1 \cong X_2$.

(ii) Let D_1 and D_2 be the closed discs in \mathbb{R}^2 given by

$$D_1 = \{\langle x, y \rangle : x^2 + y^2 \leq c_1\}$$

and

$$D_2 = \{\langle x, y \rangle : x^2 + y^2 \leq c_2\}$$

where c_1 and c_2 are positive real numbers. Prove that the topological space $D_1 \cong D_2$, where D_1 and D_2 have their subspace topologies.

(iii) Prove that $X_1 \cong D_1$.

5. Let X_1 and X_2 be subspaces of \mathbb{R} given by $X_1 = (0, 1) \cup (3, 4)$ and $X_2 = (0, 1) \cup (1, 2)$. Is $X_1 \cong X_2$? (Justify your answer.)
6. (**Group of Homeomorphisms**) Let (X, \mathcal{T}) be any topological space and G the set of all homeomorphisms of X into itself.
- (i) Show that G is a group under the operation of composition of functions.
 - (ii) If $X = [0, 1]$, show that G is infinite.
 - (iii) If $X = [0, 1]$, is G an abelian group?
7. Let (X, \mathcal{T}) and (Y, \mathcal{T}_1) be homeomorphic topological spaces. Prove that
- (i) If (X, \mathcal{T}) is a T_0 -space, then (Y, \mathcal{T}_1) is a T_0 -space.
 - (ii) If (X, \mathcal{T}) is a T_1 -space, then (Y, \mathcal{T}_1) is a T_1 -space.
 - (iii) If (X, \mathcal{T}) is a Hausdorff space, then (Y, \mathcal{T}_1) is a Hausdorff space.
 - (iv) If (X, \mathcal{T}) satisfies the second axiom of countability, then (Y, \mathcal{T}_1) satisfies the second axiom of countability.
 - (v) If (X, \mathcal{T}) is a separable space, then (Y, \mathcal{T}_1) is a separable space.
- 8.* Let (X, \mathcal{T}) be a discrete topological space. Prove that (X, \mathcal{T}) is homeomorphic to a subspace of \mathbb{R} if and only if X is countable.

4.3 Non-Homeomorphic Spaces

To prove two topological spaces are homeomorphic we have to find a homeomorphism between them.

But, to prove that two topological spaces are not homeomorphic is often much harder as we have to show that no homeomorphism exists. The following example gives us a clue as to how we might go about showing this.

4.3.1 Example. Prove that $[0, 2]$ is not homeomorphic to the subspace $[0, 1] \cup [2, 3]$ of \mathbb{R} .

Proof. Let $(X, \mathcal{T}) = [0, 2]$ and $(Y, \mathcal{T}_1) = [0, 1] \cup [2, 3]$. Then

$$[0, 1] = [0, 1] \cap Y \Rightarrow [0, 1] \text{ is closed in } (Y, \mathcal{T}_1)$$

and

$$[0, 1] = (-1, 1\frac{1}{2}) \cap Y \Rightarrow [0, 1] \text{ is open in } (Y, \mathcal{T}_1).$$

Thus Y is not connected, as it has $[0, 1]$ as a proper non-empty clopen subset.

Suppose that $(X, \mathcal{T}) \cong (Y, \mathcal{T}_1)$. Then there exists a homeomorphism $f: (X, \mathcal{T}) \rightarrow (Y, \mathcal{T}_1)$. So $f^{-1}([0, 1])$ is a clopen subset of X , and hence X is not connected. This is false as $[0, 2] = X$ is connected. (See Exercises 4.1 #15.) So we have a contradiction and thus $(X, \mathcal{T}) \not\cong (Y, \mathcal{T}_1)$. \square

What do we learn from this?

4.3.2 Proposition. Any topological space homeomorphic to a connected space is connected. \square

Proposition 4.3.2 gives us one way to try to show two topological spaces are not homeomorphic ... by finding a property “preserved by homeomorphisms” which one space has and the other does not.

Amongst the exercises we have met many properties “preserved by homeomorphisms”:

- (i) T_0 -space;
- (ii) T_1 -space;
- (iii) T_2 -space or Hausdorff space;
- (iv) regular space;
- (v) T_3 -space;
- (vi) satisfying the second axiom of countability;
- (vii) separable space. [See Exercises 4.2 #7.]

There are also others:

- (viii) discrete space;
- (ix) indiscrete space;
- (x) finite-closed topology;
- (xi) countable-closed topology.

So together with connectedness we know twelve properties preserved by homeomorphisms. Also two spaces (X, \mathcal{T}) and (Y, \mathcal{T}_1) cannot be homeomorphic if X and Y have different cardinalities (e.g. X is countable and Y is uncountable) or if \mathcal{T} and \mathcal{T}_1 have different cardinalities.

Nevertheless when faced with a specific problem we may not have the one we need. For example, show that $(0, 1)$ is not homeomorphic to $[0, 1]$ or show that \mathbb{R} is not homeomorphic to \mathbb{R}^2 . We shall see how to show that these spaces are not homeomorphic shortly.

Before moving on to this let us settle the following question: which subspaces of \mathbb{R} are connected?

4.3.3 Definition. A subset S of \mathbb{R} is said to be an **interval** if it has the following property: if $x \in S$, $z \in S$, and $y \in \mathbb{R}$ are such that $x < y < z$, then $y \in S$.

4.3.4 Remarks. Note that each singleton set $\{x\}$ is an interval.

(ii) Every interval has one of the following forms: $\{a\}$, $[a, b]$, (a, b) , $[a, b)$, $(a, b]$, $(-\infty, a)$, $(-\infty, a]$, (a, ∞) , $[a, \infty)$, $(-\infty, \infty)$.

(iii) It follows from Example 4.2.6, Remark 4.2.7, and Exercises 4.2 #1, that every interval is homeomorphic to $(0, 1)$, $[0, 1]$, $[0, 1)$, or $\{0\}$. In Exercises 4.3 #1 we are able to make an even stronger statement.

4.3.5 Proposition. A subspace S of \mathbb{R} is connected if and only if it is an interval.

Proof. That all intervals are connected can be proved in a similar fashion to Proposition 3.3.3 by replacing \mathbb{R} everywhere in the proof by the interval we are trying to prove connected.

Conversely, let S be connected. Suppose $x \in S$, $z \in S$, $x < y < z$, and $y \notin S$. Then $(-\infty, y) \cap S = (-\infty, y] \cap S$ is an open and closed subset of S . So S has a clopen subset, namely $(-\infty, y) \cap S$. To show that S is not connected we have to verify only that this clopen set is proper and non-empty. It is non-empty as it contains x . It is proper as $z \in S$ but $z \notin (-\infty, y) \cap S$. So S is not connected. This is a contradiction. Therefore S is an interval. \square

We now see a reason for the name “connected”. Subspaces of \mathbb{R} such as $[a, b]$, (a, b) , etc. are connected, while subspaces like

$$X = [0, 1] \cup [2, 3] \cup [5, 6]$$

which is a union of “disconnected” pieces, are not connected.

Now let us turn to the problem of showing that $(0, 1) \not\cong [0, 1]$. Firstly, we present a seemingly trivial observation.

4.3.6 Remark. Let $f : (X, \mathcal{T}) \rightarrow (Y, \mathcal{T}_1)$ be a homeomorphism. Let $a \in X$, so that $X \setminus \{a\}$ is a subspace of X and has induced topology \mathcal{T}_2 . Also $Y \setminus \{f(a)\}$ is a subspace of Y and has induced topology \mathcal{T}_3 . Then $(X \setminus \{a\}, \mathcal{T}_2)$ is homeomorphic to $(Y \setminus \{f(a)\}, \mathcal{T}_3)$.

Outline Proof. Define $g : X \setminus \{a\} \rightarrow Y \setminus \{f(a)\}$ by $g(x) = f(x)$, for all $x \in X \setminus \{a\}$. Then it is easily verified that g is a homeomorphism. (Write down a proof of this.) \square

As an immediate consequence of this we have:

4.3.7 Corollary. If a, b, c , and d are real numbers with $a < b$ and $c < d$, then

- (i) $(a, b) \not\cong [c, d]$,
- (ii) $(a, b) \not\cong [c, d]$, and
- (iii) $[a, b] \not\cong [c, d]$.

Proof. (i) Let $(X, \mathcal{T}) = [c, d]$ and $(Y, \mathcal{T}_1) = (a, b)$. **Suppose** that $(X, \mathcal{T}) \cong (Y, \mathcal{T}_1)$. Then $X \setminus \{c\} \cong Y \setminus \{y\}$, for some $y \in Y$. But, $X \setminus \{c\} = (c, d)$ is an interval, and so is connected, while no matter which point we remove from (a, b) the resultant space is disconnected. Hence by Proposition 4.3.2,

$$X \setminus \{c\} \not\cong Y \setminus \{y\}, \text{ for each } y \in Y.$$

This is a contradiction. So $[c, d] \not\cong (a, b)$.

(ii) $[c, d] \setminus \{c\}$ is connected, while $(a, b) \setminus \{y\}$ is disconnected for all $y \in (a, b)$. Thus $(a, b) \not\cong [c, d]$.

(iii) **Suppose** that $[a, b] \cong [c, d]$. Then $[c, d] \setminus \{c\} \cong [a, b] \setminus \{y\}$ for some $y \in [a, b]$. Therefore $([c, d] \setminus \{c\}) \setminus \{d\} \cong ([a, b] \setminus \{y\}) \setminus \{z\}$, for some $z \in [a, b] \setminus \{y\}$; that is, $(c, d) \cong [a, b] \setminus \{y, z\}$, for some distinct y and z in $[a, b]$. But (c, d) is connected, while $[a, b] \setminus \{y, z\}$, for any two distinct points y and z in $[a, b]$, is disconnected. So we have a contradiction. Therefore $[a, b] \not\cong [c, d]$. \square

Exercises 4.3

1. Deduce from the above that every interval is homeomorphic to one and only one of the following spaces:

$$\{0\}; \quad (0, 1); \quad [0, 1]; \quad [0, 1).$$

2. Deduce from Proposition 4.3.5 that every countable subspace of \mathbb{R} with more than one point is disconnected. (In particular, \mathbb{Z} and \mathbb{Q} are disconnected.)

3. Let X be the unit circle in \mathbb{R}^2 ; that is, $X = \{\langle x, y \rangle : x^2 + y^2 = 1\}$ and has the subspace topology.

(i) Show that $X \setminus \{\langle 1, 0 \rangle\}$ is homeomorphic to the open interval $(0, 1)$.

(ii) Deduce that $X \not\cong (0, 1)$ and $X \not\cong [0, 1]$.

– (iii)] Observing that for every point $a \in X$, the subspace $X \setminus \{a\}$ is connected, show that $X \not\cong [0, 1)$.

(iv) Deduce that X is not homeomorphic to any interval.

4. Let Y be the subspace of \mathbb{R}^2 given by

$$Y = \{\langle x, y \rangle : x^2 + y^2 = 1\} \cup \{\langle x, y \rangle : (x - 2)^2 + y^2 = 1\}$$

(i) Is Y homeomorphic to the space X in Exercise 3 above?

(ii) Is Y homeomorphic to an interval?

5. Let Z be the subspace of \mathbb{R}^2 given by

$$Z = \{\langle x, y \rangle : x^2 + y^2 = 1\} \cup \{\langle x, y \rangle : (x - 3/2)^2 + y^2 = 1\}.$$

Show that

(i) Z is not homeomorphic to any interval, and

(ii) Z is not homeomorphic to X or Y , the spaces described in Exercises 3 and 4 above.

6. Prove that the Sorgenfrey line is not homeomorphic to \mathbb{R} , \mathbb{R}^2 , or any subspace of either of these spaces.

7. (i) Prove that the topological space in Exercises 1.1 #5 (i) is not homeomorphic to the space in Exercises 1.1 #9 (ii).
- (ii)* In Exercises 1.1 #5, is $(X, \mathcal{T}_1) \cong (X, \mathcal{T}_2)$?
- (iii)* In Exercises 1.1 # 9, is $(X, \mathcal{T}_2) \cong (X, \mathcal{T}_9)$?
8. Let (X, \mathcal{T}) be a topological space, where X is an infinite set. Prove each of the following statements (originally proved by John Ginsburg and Bill Sands).
- (i)* (X, \mathcal{T}) has a subspace homeomorphic to $(\mathbb{N}, \mathcal{T}_1)$, where either \mathcal{T}_1 is the indiscrete topology or $(\mathbb{N}, \mathcal{T}_1)$ is a T_0 -space.
- (ii)** Let (X, \mathcal{T}) be a T_1 -space. Then (X, \mathcal{T}) has a subspace homeomorphic to $(\mathbb{N}, \mathcal{T}_2)$, where \mathcal{T}_2 is either the finite-closed topology or the discrete topology.
- (iii) Deduce from (ii), that any infinite Hausdorff space contains an infinite discrete subspace and hence a subspace homeomorphic to \mathbb{N} with the discrete topology.
- (iv)** Let (X, \mathcal{T}) be a T_0 -space which is not a T_1 -space. Then the space (X, \mathcal{T}) has a subspace homeomorphic to $(\mathbb{N}, \mathcal{T}_3)$, where \mathcal{T}_3 consists of \mathbb{N} , \emptyset , and all of the sets $\{1, 2, \dots, n\}$, $n \in \mathbb{N}$ or \mathcal{T}_3 consists of \mathbb{N} , \emptyset , and all of the sets $\{n, n+1, \dots\}$, $n \in \mathbb{N}$.
- (v) Deduce from the above that every infinite topological space has a subspace homeomorphic to $(\mathbb{N}, \mathcal{T}_4)$ where \mathcal{T}_4 is the indiscrete topology, the discrete topology, the finite-closed topology, or one of the two topologies described in (iv), known as the **initial segment topology** and the **final segment topology**, respectively. Further, no two of these five topologies on \mathbb{N} are homeomorphic.

9. Let (X, \mathcal{T}) and (Y, \mathcal{T}_1) be topological spaces. A map $f : X \rightarrow Y$ is said to be a **local homeomorphism** if each point $x \in X$ has an open neighbourhood U such that f maps U homeomorphically onto an open subspace V of (Y, \mathcal{T}_1) ; that is, if the topology induced on U by \mathcal{T} is \mathcal{T}_2 and the topology induced on $V = f(U)$ by \mathcal{T}_1 is \mathcal{T}_3 , then f is a homeomorphism of (U, \mathcal{T}_2) onto (V, \mathcal{T}_3) . The topological space (X, \mathcal{T}) is said to be **locally homeomorphic** to (Y, \mathcal{T}_1) if there exists a local homeomorphism of (X, \mathcal{T}) into (Y, \mathcal{T}_1) .
- (i) If (X, \mathcal{T}) and (Y, \mathcal{T}_1) are homeomorphic topological spaces, verify that (X, \mathcal{T}) is locally homeomorphic to (Y, \mathcal{T}_1) .
 - (ii) If (X, \mathcal{T}) is an open subspace of (Y, \mathcal{T}_1) , prove that (X, \mathcal{T}) is locally homeomorphic to (Y, \mathcal{T}_1) .
 - (iii)* Prove that if $f : (X, \mathcal{T}) \rightarrow (Y, \mathcal{T}_1)$ is a local homeomorphism, then f maps every open subset of (X, \mathcal{T}) onto an open subset of (Y, \mathcal{T}_1) .

4.4 Postscript

There are three important ways of creating new topological spaces from old ones: forming subspaces, products, and quotient spaces. We examine all three in due course. Forming subspaces was studied in this section. This allowed us to introduce the important spaces \mathbb{Q} , $[a, b]$, (a, b) , etc.

We defined the central notion of homeomorphism. We noted that “ \cong ” is an equivalence relation. A property is said to be **topological** if it is preserved by homeomorphisms; that is, if $(X, \mathcal{T}) \cong (Y, \mathcal{T}_1)$ and (X, \mathcal{T}) has the property then (Y, \mathcal{T}_1) must also have the property. Connectedness was shown to be a topological property. So any space homeomorphic to a connected space is connected. (A number of other topological properties were also identified.) We formally defined the notion of an interval in \mathbb{R} , and showed that the intervals are precisely the connected subspaces of \mathbb{R} .

Given two topological spaces (X, \mathcal{T}) and (Y, \mathcal{T}_1) it is an interesting task to show whether they are homeomorphic or not. We proved that every interval in \mathbb{R} is homeomorphic to one and only one of $[0, 1]$, $(0, 1)$, $[0, 1)$, and $\{0\}$. In the next section we show that \mathbb{R} is not homeomorphic to \mathbb{R}^2 . A tougher problem is to show that \mathbb{R}^2 is not homeomorphic to \mathbb{R}^3 . This will be done later via the Jordan curve theorem. Still the *crème de la crème* is the fact that $\mathbb{R}^n \cong \mathbb{R}^m$ if and only if $n = m$. This is best approached via algebraic topology, which is only touched upon in this book.

Exercises 4.2 #6 introduced the notion of group of homeomorphisms, which is an interesting and important topic in its own right.

Chapter 5

Continuous Mappings

Introduction

In most branches of pure mathematics we study what in category theory are called “objects” and “arrows”. In linear algebra the objects are vector spaces and the arrows are linear transformations. In group theory the objects are groups and the arrows are homomorphisms, while in set theory the objects are sets and the arrows are functions. In topology the objects are the topological spaces. We now introduce the arrows ... the continuous mappings.

5.1 Continuous Mappings

Of course we are already familiar¹ with the notion of a continuous function from \mathbb{R} into \mathbb{R} .

A function $f : \mathbb{R} \rightarrow \mathbb{R}$ is said to be **continuous** if for each $a \in \mathbb{R}$ and each positive real number ε , there exists a positive real number δ such that $|x - a| < \delta$ implies $|f(x) - f(a)| < \varepsilon$.

It is not at all obvious how to generalize this definition to general topological spaces where we do not have “absolute value” or “subtraction”. So we shall seek another (equivalent) definition of continuity which lends itself more to generalization.

It is easily seen that $f : \mathbb{R} \rightarrow \mathbb{R}$ is continuous if and only if for each $a \in \mathbb{R}$ and each interval $(f(a) - \varepsilon, f(a) + \varepsilon)$, for $\varepsilon > 0$, there exists a $\delta > 0$ such that $f(x) \in (f(a) - \varepsilon, f(a) + \varepsilon)$ for all $x \in (a - \delta, a + \delta)$.

This definition is an improvement since it does not involve the concept “absolute value” but it still involves “subtraction”. The next lemma shows how to avoid subtraction.

¹The early part of this section assumes that you have some knowledge of real analysis and, in particular, the ε - δ definition of continuity. If this is not the case, then proceed directly to Definition 5.1.3.

5.1.1 Lemma. Let f be a function mapping \mathbb{R} into itself. Then f is continuous if and only if for each $a \in \mathbb{R}$ and each open set U containing $f(a)$, there exists an open set V containing a such that $f(V) \subseteq U$.

Proof. Assume that f is continuous. Let $a \in \mathbb{R}$ and let U be any open set containing $f(a)$. Then there exist real numbers c and d such that $f(a) \in (c, d) \subseteq U$. Put ε equal to the smaller of the two numbers $d - f(a)$ and $f(a) - c$, so that

$$(f(a) - \varepsilon, f(a) + \varepsilon) \subseteq U.$$

As the mapping f is continuous there exists a $\delta > 0$ such that $f(x) \in (f(a) - \varepsilon, f(a) + \varepsilon)$ for all $x \in (a - \delta, a + \delta)$. Let V be the open set $(a - \delta, a + \delta)$. Then $a \in V$ and $f(V) \subseteq U$, as required.

Conversely assume that for each $a \in \mathbb{R}$ and each open set U containing $f(a)$ there exists an open set V containing a such that $f(V) \subseteq U$. We have to show that f is continuous. Let $a \in \mathbb{R}$ and ε be any positive real number. Put $U = (f(a) - \varepsilon, f(a) + \varepsilon)$. So U is an open set containing $f(a)$. Therefore there exists an open set V containing a such that $f(V) \subseteq U$. As V is an open set containing a , there exist real numbers c and d such that $a \in (c, d) \subseteq V$. Put δ equal to the smaller of the two numbers $d - a$ and $a - c$, so that $(a - \delta, a + \delta) \subseteq V$. Then for all $x \in (a - \delta, a + \delta)$, $f(x) \in f(V) \subseteq U$, as required. So f is continuous. \square

We could use the property described in Lemma 5.1.1 to define continuity, however the following lemma allows us to make a more elegant definition.

5.1.2 Lemma. Let f be a mapping of a topological space (X, \mathcal{T}) into a topological space (Y, \mathcal{T}') . Then the following two conditions are equivalent:

- (i) for each $U \in \mathcal{T}'$, $f^{-1}(U) \in \mathcal{T}$,
- (ii) for each $a \in X$ and each $U \in \mathcal{T}'$ with $f(a) \in U$, there exists a $V \in \mathcal{T}$ such that $a \in V$ and $f(V) \subseteq U$.

Proof. Assume that condition (i) is satisfied. Let $a \in X$ and $U \in \mathcal{T}'$ with $f(a) \in U$. Then $f^{-1}(U) \in \mathcal{T}$. Put $V = f^{-1}(U)$, and we have that $a \in V$, $V \in \mathcal{T}$, and $f(V) \subseteq U$. So condition (ii) is satisfied.

Conversely, assume that condition (ii) is satisfied. Let $U \in \mathcal{T}'$. If $f^{-1}(U) = \emptyset$ then clearly $f^{-1}(U) \in \mathcal{T}$. If $f^{-1}(U) \neq \emptyset$, let $a \in f^{-1}(U)$. Then $f(a) \in U$. Therefore there exists a $V \in \mathcal{T}$ such that $a \in V$ and $f(V) \subseteq U$. So for each $a \in f^{-1}(U)$ there exists a $V \in \mathcal{T}$ such that $a \in V \subseteq f^{-1}(U)$. By Corollary 3.2.9 this implies that $f^{-1}(U) \in \mathcal{T}$. So condition (i) is satisfied. \square

Putting together Lemmas 5.1.1 and 5.1.2 we see that $f : \mathbb{R} \rightarrow \mathbb{R}$ is continuous if and only if for each open subset U of \mathbb{R} , $f^{-1}(U)$ is an open set.

This leads us to define the notion of a continuous function between two topological spaces as follows:

5.1.3 Definition. Let (X, \mathcal{T}) and (Y, \mathcal{T}_1) be topological spaces and f a function from X into Y . Then $f : (X, \mathcal{T}) \rightarrow (Y, \mathcal{T}_1)$ is said to be a **continuous mapping** if for each $U \in \mathcal{T}_1$, $f^{-1}(U) \in \mathcal{T}$.

From the above remarks we see that this definition of continuity coincides with the usual definition when $(X, \mathcal{T}) = (Y, \mathcal{T}_1) = \mathbb{R}$.

Let us go through a few easy examples to see how nice this definition of continuity is to apply in practice.

5.1.4 Example. Consider $f : \mathbb{R} \rightarrow \mathbb{R}$ given by $f(x) = x$, for all $x \in \mathbb{R}$; that is, f is the identity function. Then for any open set U in \mathbb{R} , $f^{-1}(U) = U$ and so is open. Hence f is continuous. \square

5.1.5 Example. Let $f : \mathbb{R} \rightarrow \mathbb{R}$ be given by $f(x) = c$, for c a constant, and all $x \in \mathbb{R}$. Then let U be any open set in \mathbb{R} . Clearly $f^{-1}(U) = \mathbb{R}$ if $c \in U$ and \emptyset if $c \notin U$. In both cases, $f^{-1}(U)$ is open. So f is continuous. \square

5.1.6 Example. Consider $f : \mathbb{R} \rightarrow \mathbb{R}$ defined by

$$f(x) = \begin{cases} x - 1, & \text{if } x \leq 3 \\ \frac{1}{2}(x + 5), & \text{if } x > 3. \end{cases}$$

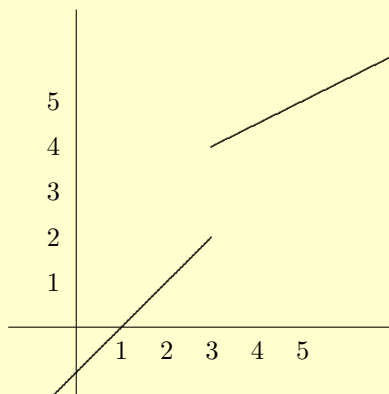

Recall that a mapping is continuous if and only if the inverse image of every open set is an open set.

Therefore, to show f is not continuous we have to find only one set U such that $f^{-1}(U)$ is not open.

Then $f^{-1}((1, 3)) = (2, 3]$, which is not an open set. Therefore f is not continuous. \square

Note that Lemma 5.1.2 can now be restated in the following way.²

5.1.7 Proposition. Let f be a mapping of a topological space (X, \mathcal{T}) into a space (Y, \mathcal{T}') . Then f is continuous if and only if for each $x \in X$ and each $U \in \mathcal{T}'$ with $f(x) \in U$, there exists a $V \in \mathcal{T}$ such that $x \in V$ and $f(V) \subseteq U$. \square

5.1.8 Proposition. Let (X, \mathcal{T}) , (Y, \mathcal{T}_1) and (Z, \mathcal{T}_2) be topological spaces. If $f : (X, \mathcal{T}) \rightarrow (Y, \mathcal{T}_1)$ and $g : (Y, \mathcal{T}_1) \rightarrow (Z, \mathcal{T}_2)$ are continuous mappings, then the composite function $g \circ f : (X, \mathcal{T}) \rightarrow (Z, \mathcal{T}_2)$ is continuous.

Proof.

To prove that the composite function $g \circ f : (X, \mathcal{T}) \rightarrow (Z, \mathcal{T}_2)$ is continuous, we have to show that if $U \in \mathcal{T}_2$, then $(g \circ f)^{-1}(U) \in \mathcal{T}$.

But $(g \circ f)^{-1}(U) = f^{-1}(g^{-1}(U))$.

Let U be open in (Z, \mathcal{T}_2) . Since g is continuous, $g^{-1}(U)$ is open in \mathcal{T}_1 . Then $f^{-1}(g^{-1}(U))$ is open in \mathcal{T} as f is continuous. But $f^{-1}(g^{-1}(U)) = (g \circ f)^{-1}(U)$. Thus $g \circ f$ is continuous. \square

The next result shows that continuity can be described in terms of closed sets instead of open sets if we wish.

5.1.9 Proposition. Let (X, \mathcal{T}) and (Y, \mathcal{T}_1) be topological spaces. Then $f : (X, \mathcal{T}) \rightarrow (Y, \mathcal{T}_1)$ is continuous if and only if for every closed subset S of Y , $f^{-1}(S)$ is a closed subset of X .

Proof. This result follows immediately once you recognize that

$$f^{-1}(\text{complement of } S) = \text{complement of } f^{-1}(S).$$

\square

²If you have not read Lemma 5.1.2 and its proof you should do so now.

5.1.10 Remark. There is a relationship between continuous maps and homeomorphisms: if $f : (X, \mathcal{T}) \rightarrow (Y, \mathcal{T}_1)$ is a homeomorphism then it is a continuous map. Of course not every continuous map is a homeomorphism.

However the following proposition, whose proof follows from the definitions of “continuous” and “homeomorphism” tells the full story.

5.1.11 Proposition. Let (X, \mathcal{T}) and (Y, \mathcal{T}') be topological spaces and f a function from X into Y . Then f is a homeomorphism if and only if

- (i) f is continuous,
- (ii) f is one-to-one and onto; that is, the inverse function $f^{-1} : Y \rightarrow X$ exists, and
- (iii) f^{-1} is continuous. □

A useful result is the following proposition which tells us that the restriction of a continuous map is a continuous map. Its routine proof is left to the reader – see also Exercise Set 5.1 #8.

5.1.12 Proposition. Let (X, \mathcal{T}) and (Y, \mathcal{T}_1) be topological spaces, $f : (X, \mathcal{T}) \rightarrow (Y, \mathcal{T}_1)$ a continuous mapping, A a subset of X , and \mathcal{T}_2 the induced topology on A . Further let $g : (A, \mathcal{T}_2) \rightarrow (Y, \mathcal{T}_1)$ be the restriction of f to A ; that is, $g(x) = f(x)$, for all $x \in A$. Then g is continuous.

Exercises 5.1

1. (i) Let $f : (X, \mathcal{T}) \rightarrow (Y, \mathcal{T}_1)$ be a constant function. Show that f is continuous.
 (ii) Let $f : (X, \mathcal{T}) \rightarrow (X, \mathcal{T})$ be the identity function. Show that f is continuous.

2. Let $f : \mathbb{R} \rightarrow \mathbb{R}$ be given by

$$f(x) = \begin{cases} -1, & x \leq 0 \\ 1, & x > 0. \end{cases}$$

- (i) Prove that f is not continuous using the method of Example 5.1.6.
 (ii) Find $f^{-1}\{1\}$ and, using Proposition 5.1.9, deduce that f is not continuous.
3. Let $f : \mathbb{R} \rightarrow \mathbb{R}$ be given by

$$f(x) = \begin{cases} x, & x \leq 1 \\ x + 2, & x > 1. \end{cases}$$

Is f continuous? (Justify your answer.)

4. Let (X, \mathcal{T}) be the subspace of \mathbb{R} given by $X = [0, 1] \cup [2, 4]$. Define $f : (X, \mathcal{T}) \rightarrow \mathbb{R}$ by

$$f(x) = \begin{cases} 1, & \text{if } x \in [0, 1] \\ 2, & \text{if } x \in [2, 4]. \end{cases}$$

Prove that f is continuous. (Does this surprise you?)

5. Let (X, \mathcal{T}) and (Y, \mathcal{T}_1) be topological spaces and \mathcal{B}_1 a basis for the topology \mathcal{T}_1 . Show that a map $f : (X, \mathcal{T}) \rightarrow (Y, \mathcal{T}_1)$ is continuous if and only if $f^{-1}(U) \in \mathcal{T}$, for every $U \in \mathcal{B}_1$.
6. Let (X, \mathcal{T}) and (Y, \mathcal{T}_1) be topological spaces and f a mapping of X into Y . If (X, \mathcal{T}) is a discrete space, prove that f is continuous.
7. Let (X, \mathcal{T}) and (Y, \mathcal{T}_1) be topological spaces and f a mapping of X into Y . If (Y, \mathcal{T}_1) is an indiscrete space, prove that f is continuous.
8. Let (X, \mathcal{T}) and (Y, \mathcal{T}_1) be topological spaces and $f : (X, \mathcal{T}) \rightarrow (Y, \mathcal{T}_1)$ a continuous mapping. Let A be a subset of X , \mathcal{T}_2 the induced topology on A , $B = f(A)$, \mathcal{T}_3 the induced topology on B and $g : (A, \mathcal{T}_2) \rightarrow (B, \mathcal{T}_3)$ the restriction of f to A . Prove that g is continuous.

9. Let f be a mapping of a space (X, \mathcal{T}) into a space (Y, \mathcal{T}') . Prove that f is continuous if and only if for each $x \in X$ and each neighbourhood N of $f(x)$ there exists a neighbourhood M of x such that $f(M) \subseteq N$.
10. Let \mathcal{T}_1 and \mathcal{T}_2 be two topologies on a set X . Then \mathcal{T}_1 is said to be a **finer topology** than \mathcal{T}_2 (and \mathcal{T}_2 is said to be a **coarser topology** than \mathcal{T}_1) if $\mathcal{T}_1 \supseteq \mathcal{T}_2$. Prove that
- (i) the Euclidean topology \mathbb{R} is finer than the finite-closed topology on \mathbb{R} ;
 - (ii) the identity function $f : (X, \mathcal{T}_1) \rightarrow (X, \mathcal{T}_2)$ is continuous if and only if \mathcal{T}_1 is a finer topology than \mathcal{T}_2 .
11. Let $f : \mathbb{R} \rightarrow \mathbb{R}$ be a continuous function such that $f(q) = 0$ for every rational number q . Prove that $f(x) = 0$ for every $x \in \mathbb{R}$.
12. Let (X, \mathcal{T}) and (Y, \mathcal{T}_1) be topological spaces and $f : (X, \mathcal{T}) \rightarrow (Y, \mathcal{T}_1)$ a continuous map. If f is one-to-one, prove that
- (i) (Y, \mathcal{T}_1) Hausdorff implies (X, \mathcal{T}) Hausdorff.
 - (ii) (Y, \mathcal{T}_1) a T_1 -space implies (X, \mathcal{T}) is a T_1 -space.
13. Let (X, \mathcal{T}) and (Y, \mathcal{T}_1) be topological spaces and let f be a mapping of (X, \mathcal{T}) into (Y, \mathcal{T}_1) . Prove that f is continuous if and only if for every subset A of X , $f(\overline{A}) \subseteq \overline{f(A)}$.

[Hint: Use Proposition 5.1.9.]

5.2 Intermediate Value Theorem

5.2.1 Proposition. Let (X, \mathcal{T}) and (Y, \mathcal{T}_1) be topological spaces and $f : (X, \mathcal{T}) \rightarrow (Y, \mathcal{T}_1)$ surjective and continuous. If (X, \mathcal{T}) is connected, then (Y, \mathcal{T}_1) is connected.

Proof. Suppose (Y, \mathcal{T}_1) is not connected. Then it has a clopen subset U such that $U \neq \emptyset$ and $U \neq Y$. Then $f^{-1}(U)$ is an open set, since f is continuous, and also a closed set, by Proposition 5.1.9; that is, $f^{-1}(U)$ is a clopen subset of X . Now $f^{-1}(U) \neq \emptyset$ as f is surjective and $U \neq \emptyset$. Also $f^{-1}(U) \neq X$, since if it were U would equal Y , by the surjectivity of f . Thus (X, \mathcal{T}) is not connected. This is a contradiction. Therefore (Y, \mathcal{T}_1) is connected. \square

5.2.2 Remarks. (i) The above proposition would be false if the condition “surjective” were dropped. (Find an example of this.)

(ii) Simply put, Proposition 5.2.1 says: **any continuous image of a connected set is connected.**

(iii) Proposition 5.2.1 tells us that if (X, \mathcal{T}) is a connected space and (Y, \mathcal{T}') is not connected (i.e. **disconnected**) then there exists no mapping of (X, \mathcal{T}) onto (Y, \mathcal{T}') which is continuous. For example, while there are an infinite number of mappings of \mathbb{R} onto \mathbb{Q} (or onto \mathbb{Z}), none of them are continuous. Indeed in Exercise Set 5.2 # 10 we observe that the only continuous mappings of \mathbb{R} into \mathbb{Q} (or into \mathbb{Z}) are the constant mappings. \square

The following strengthened version of the notion of connectedness is often useful.

5.2.3 Definition. A topological space (X, \mathcal{T}) is said to be **path-connected** (or **pathwise connected**) if for each pair of distinct points a and b of X there exists a continuous mapping $f : [0, 1] \rightarrow (X, \mathcal{T})$, such that $f(0) = a$ and $f(1) = b$. The mapping f is said to be a **path joining a to b .**

5.2.4 Example. It is readily seen that every interval is path-connected. \square

5.2.5 Example. For each $n \geq 1$, \mathbb{R}^n is path-connected. \square

5.2.6 Proposition. Every path-connected space is connected.

Proof. Let (X, \mathcal{T}) be a path-connected space and suppose that it is not connected.

Then it has a proper non-empty clopen subset U . So there exist a and b such that $a \in U$ and $b \in X \setminus U$. As (X, \mathcal{T}) is path-connected there exists a continuous function $f : [0, 1] \rightarrow (X, \mathcal{T})$ such that $f(0) = a$ and $f(1) = b$.

However, $f^{-1}(U)$ is a clopen subset of $[0, 1]$. As $a \in U$, $0 \in f^{-1}(U)$ and so $f^{-1}(U) \neq \emptyset$. As $b \notin U$, $1 \notin f^{-1}(U)$ and thus $f^{-1}(U) \neq [0, 1]$. Hence $f^{-1}(U)$ is a proper non-empty clopen subset of $[0, 1]$, which contradicts the connectedness of $[0, 1]$.

Consequently (X, \mathcal{T}) is connected. \square

5.2.7 Remark. The converse of Proposition 5.2.6 is false; that is, not every connected space is path-connected. An example of such a space is the following subspace of \mathbb{R}^2 :

$$X = \{(x, y) : y = \sin(1/x), 0 < x \leq 1\} \cup \{(0, y) : -1 \leq y \leq 1\}.$$

[Exercise Set 5.2 #6 shows that X is connected. That X is not path-connected can be seen by showing that there is no path joining $\langle 0, 0 \rangle$ to, say, the point $\langle 1/\pi, 0 \rangle$. Draw a picture and try to convince yourself of this.] □

We can now show that $\mathbb{R} \not\cong \mathbb{R}^2$.

5.2.8 Example. Clearly $\mathbb{R}^2 \setminus \{(0, 0)\}$ is path-connected and hence, by Proposition 5.2.6, is connected. However $\mathbb{R} \setminus \{a\}$, for any $a \in \mathbb{R}$, is disconnected. Hence $\mathbb{R} \not\cong \mathbb{R}^2$. □

We now present the Weierstrass Intermediate Value Theorem which is a beautiful application of topology to the theory of functions of a real variable. The topological concept crucial to the result is that of connectedness.

5.2.9 Theorem. (Weierstrass Intermediate Value Theorem) Let $f : [a, b] \rightarrow \mathbb{R}$ be continuous and let $f(a) \neq f(b)$. Then for every number p between $f(a)$ and $f(b)$ there is a point $c \in [a, b]$ such that $f(c) = p$.

Proof. As $[a, b]$ is connected and f is continuous, Proposition 5.2.1 says that $f([a, b])$ is connected. By Proposition 4.3.5 this implies that $f([a, b])$ is an interval. Now $f(a)$ and $f(b)$ are in $f([a, b])$. So if p is between $f(a)$ and $f(b)$, $p \in f([a, b])$, that is, $p = f(c)$, for some $c \in [a, b]$. □

5.2.10 Corollary. If $f : [a, b] \rightarrow \mathbb{R}$ is continuous and such that $f(a) > 0$ and $f(b) < 0$, then there exists an $x \in [a, b]$ such that $f(x) = 0$. □

5.2.11 Corollary. (Fixed Point Theorem) Let f be a continuous mapping of $[0, 1]$ into $[0, 1]$. Then there exists a $z \in [0, 1]$ such that $f(z) = z$. (The point z is called a **fixed point**.)

Proof. If $f(0) = 0$ or $f(1) = 1$, the result is obviously true. Thus it suffices to consider the case when $f(0) > 0$ and $f(1) < 1$.

Let $g : [0, 1] \rightarrow \mathbb{R}$ be defined by $g(x) = x - f(x)$. Clearly g is continuous, $g(0) = -f(0) < 0$, and $g(1) = 1 - f(1) > 0$. Consequently, by Corollary 5.2.10, there exists a $z \in [0, 1]$ such that $g(z) = 0$; that is, $z - f(z) = 0$ or $f(z) = z$. \square

5.2.12 Remark. Corollary 5.2.11 is a special case of a very important theorem called the **Brouwer Fixed Point Theorem** which says that **if you map an n -dimensional cube continuously into itself then there is a fixed point**. [There are many proofs of this theorem, but most depend on methods of algebraic topology. An unsophisticated proof is given on pp. 238–239 of the book “Introduction to Set Theory and Topology”, by K. Kuratowski (Pergamon Press, 1961).]

Exercises 5.2

1. Prove that a continuous image of a path-connected space is path-connected.
2. Let f be a continuous mapping of the interval $[a, b]$ into itself, where a and $b \in \mathbb{R}$ and $a < b$. Prove that there is a fixed point.
3. (i) Give an example which shows that Corollary 5.2.11 would be false if we replaced $[0, 1]$ everywhere by $(0, 1)$.
 - (ii) A topological space (X, \mathcal{T}) is said to have the **fixed point property** if every continuous mapping of (X, \mathcal{T}) into itself has a fixed point. Show that the only intervals having the fixed point property are the closed intervals.
 - (iii) Let X be a set with at least two points. Prove that the discrete space (X, \mathcal{T}) and the indiscrete space (X, \mathcal{T}') do not have the fixed-point property.
 - (iv) Does a space which has the finite-closed topology have the fixed-point property?
 - (v) Prove that if the space (X, \mathcal{T}) has the fixed-point property and (Y, \mathcal{T}_1) is a space homeomorphic to (X, \mathcal{T}) , then (Y, \mathcal{T}_1) has the fixed-point property.

4. Let $\{A_j : j \in J\}$ be a family of connected subspaces of a topological space (X, \mathcal{T}) . If $\bigcap_{j \in J} A_j \neq \emptyset$, show that $\bigcup_{j \in J} A_j$ is connected.
5. Let A be a connected subspace of a topological space (X, \mathcal{T}) . Prove that \overline{A} is also connected. Indeed, show that if $A \subseteq B \subseteq \overline{A}$, then B is connected.
6. (i) Show that the subspace $Y = \{\langle x, y \rangle : y = \sin(1/x), 0 < x \leq 1\}$ of \mathbb{R}^2 is connected.
[Hint: Use Proposition 5.2.1.]
- (ii) Verify that $\overline{Y} = Y \cup \{\langle 0, y \rangle : -1 \leq y \leq 1\}$
- (iii) Using Exercise 5, observe that \overline{Y} is connected.
7. Let E be the set of all points in \mathbb{R}^2 having both coordinates rational. Prove that the space $\mathbb{R}^2 \setminus E$ is path-connected.
- 8.* Let C be any countable subset of \mathbb{R}^2 . Prove that the space $\mathbb{R}^2 \setminus C$ is path-connected.
9. Let (X, \mathcal{T}) be a topological space and a any point in X . The **component in X of a** , $C_X(a)$, is defined to be the union of all connected subsets of X which contain a . Show that
- (i) $C_X(a)$ is connected. (Use Exercise 4 above.)
- (ii) $C_X(a)$ is the largest connected set containing a .
- (iii) $C_X(a)$ is closed in X . (Use Exercise 5 above.)
10. A topological space (X, \mathcal{T}) is said to be **totally disconnected** if every non-empty connected subset is a singleton set. Prove the following statements.
- (i) (X, \mathcal{T}) is totally disconnected if and only if for each $a \in X$, $C_X(a) = \{a\}$. (See the notation in Exercise 9.)
- (ii) The set \mathbb{Q} of all rational numbers with the usual topology is totally disconnected.
- (iii) If f is a continuous mapping of \mathbb{R} into \mathbb{Q} , prove that there exists a $c \in \mathbb{Q}$ such that $f(x) = c$, for all $x \in \mathbb{R}$.
- (iv) Every subspace of a totally disconnected space is totally disconnected.
- (v) Every countable subspace of \mathbb{R}^2 is totally disconnected.
- (vi) The Sorgenfrey line is totally disconnected.

11. (i) Using Exercise 9, define, in the natural way, the “path-component” of a point in a topological space.
- (ii) Prove that, in any topological space, every path-component is a path-connected space.
- (iii) If (X, \mathcal{T}) is a topological space with the property that every point in X has a neighbourhood which is path-connected, prove that every path-component is an open set. Deduce that every path-component is also a closed set.
- (iv) Using (iii), show that an open subset of \mathbb{R}^2 is connected if and only if it is path-connected.
- 12.* Let A and B be subsets of a topological space (X, \mathcal{T}) . If A and B are both open or both closed, and $A \cup B$ and $A \cap B$ are both connected, show that A and B are connected.
13. A topological space (X, \mathcal{T}) is said to be **zero-dimensional** if there is a basis for the topology consisting of clopen sets. Prove the following statements.
- (i) \mathbb{Q} and \mathbb{P} are zero-dimensional spaces.
- (ii) A subspace of a zero-dimensional space is zero-dimensional.
- (iii) A zero-dimensional Hausdorff space is totally disconnected. (See Exercise 10 above.)
- (iv) Every indiscrete space is zero-dimensional.
- (v) Every discrete space is zero-dimensional.
- (vi) Indiscrete spaces with more than one point are not totally disconnected.
- (vii) A zero-dimensional T_0 -space is Hausdorff.
- (viii)* A subspace of \mathbb{R} is zero-dimensional if and only if it is totally disconnected.
14. Show that every local homeomorphism is a continuous mapping. (See Exercises 4.3#9.)

5.3 Postscript

In this chapter we said that a mapping³ between topological spaces is called “continuous” if it has the property that the inverse image of every open set is an open set. This is an elegant definition and easy to understand. It contrasts with the one we meet in real analysis which was mentioned at the beginning of this section. We have generalized the real analysis definition, not for the sake of generalization, but rather to see what is really going on.

The Weierstrass Intermediate Value Theorem seems intuitively obvious, but we now see it follows from the fact that \mathbb{R} is connected and that any continuous image of a connected space is connected.

We introduced a stronger property than connected, namely path-connected. In many cases it is not sufficient to insist that a space be connected, it must be path-connected. This property plays an important role in algebraic topology.

We shall return to the Brouwer Fixed Point Theorem in due course. It is a powerful theorem. Fixed point theorems play important roles in various branches of mathematics including topology, functional analysis, and differential equations. They are still a topic of research activity today.

In Exercises 5.2 #9 and #10 we met the notions of “component” and “totally disconnected”. Both of these are important for an understanding of connectedness.

³**Warning:** Some books use the terms “mapping” and “map” to mean continuous mapping. We do not.

Chapter 6

Metric Spaces

Introduction

The most important class of topological spaces is the class of metric spaces. Metric spaces provide a rich source of examples in topology. But more than this, most of the applications of topology to analysis are via metric spaces.

The notion of metric space was introduced in 1906 by Maurice Fréchet and developed and named by Felix Hausdorff in 1914 (Hausdorff [97]).

6.1 Metric Spaces

6.1.1 Definition. Let X be a non-empty set and d a real-valued function defined on $X \times X$ such that for $a, b \in X$:

(i) $d(a, b) \geq 0$ and $d(a, b) = 0$ if and only if $a = b$;

(ii) $d(a, b) = d(b, a)$; and

(iii) $d(a, c) \leq d(a, b) + d(b, c)$, [the triangle inequality] for all a, b and c in X .

Then d is said to be a **metric** on X , (X, d) is called a **metric space** and $d(a, b)$ is referred to as the **distance** between a and b .

6.1.2 Example. The function $d : \mathbb{R} \times \mathbb{R} \rightarrow \mathbb{R}$ given by

$$d(a, b) = |a - b|, \quad a, b \in \mathbb{R}$$

is a metric on the set \mathbb{R} since

- (i) $|a - b| \geq 0$, for all a and b in \mathbb{R} , and $|a - b| = 0$ if and only if $a = b$,
- (ii) $|a - b| = |b - a|$, and
- (iii) $|a - c| \leq |a - b| + |b - c|$. (Deduce this from $|x + y| \leq |x| + |y|$.)

We call d the **euclidean metric on \mathbb{R}** . □

6.1.3 Example. The function $d : \mathbb{R}^2 \times \mathbb{R}^2 \rightarrow \mathbb{R}$ given by

$$d(\langle a_1, a_2 \rangle, \langle b_1, b_2 \rangle) = \sqrt{(a_1 - b_1)^2 + (a_2 - b_2)^2}$$

is a metric on \mathbb{R}^2 called the **euclidean metric on \mathbb{R}^2** .

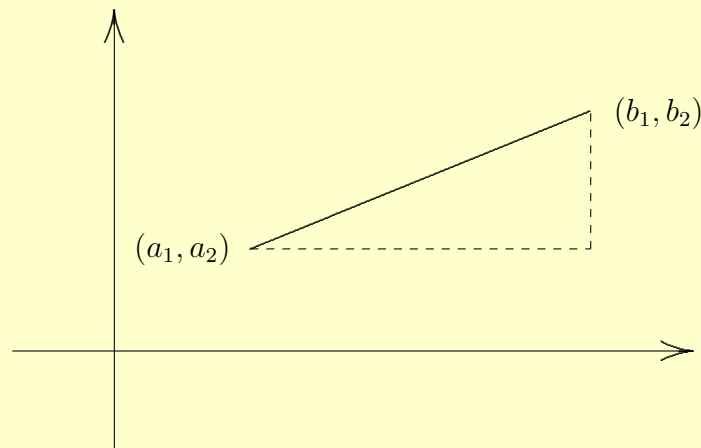

□

6.1.4 Example. Let X be a non-empty set and d the function from $X \times X$ into \mathbb{R} defined by

$$d(a, b) = \begin{cases} 0, & \text{if } a = b \\ 1, & \text{if } a \neq b. \end{cases}$$

Then d is a metric on X and is called the **discrete metric**. □

Many important examples of metric spaces are "function spaces". For these the set X on which we put a metric is a set of functions.

6.1.5 Example. Let $C[0, 1]$ denote the set of continuous functions from $[0, 1]$ into \mathbb{R} . A metric is defined on this set by

$$d(f, g) = \int_0^1 |f(x) - g(x)| dx$$

where f and g are in $C[0, 1]$.

A moment's thought should tell you that $d(f, g)$ is precisely the area of the region which lies between the graphs of the functions and the lines $x = 0$ and $x = 1$, as illustrated below.

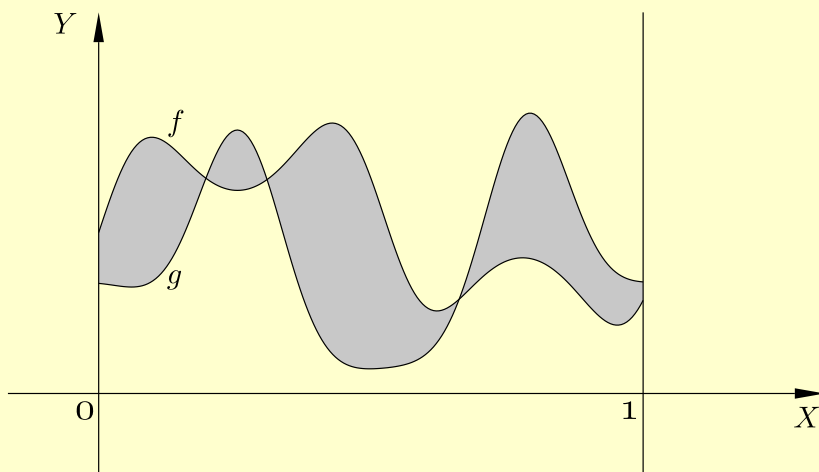

□

6.1.6 Example. Again let $C[0, 1]$ be the set of all continuous functions from $[0, 1]$ into \mathbb{R} . Another metric is defined on $C[0, 1]$ as follows:

$$d^*(f, g) = \sup\{|f(x) - g(x)| : x \in [0, 1]\}.$$

Clearly $d^*(f, g)$ is just the largest vertical gap between the graphs of the functions f and g .

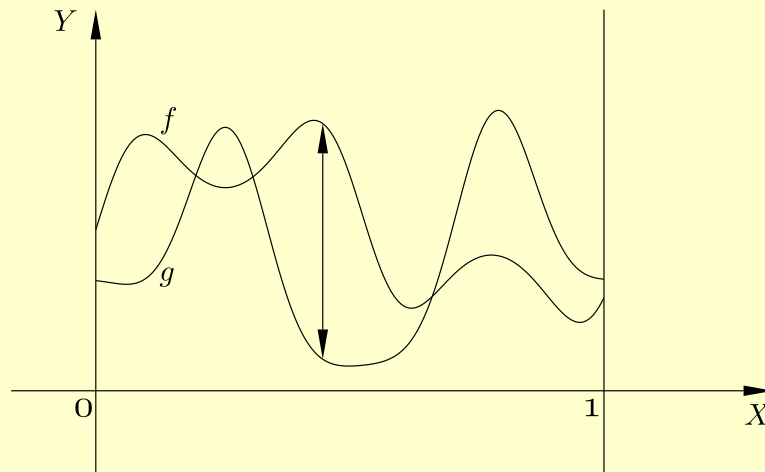

□

6.1.7 Example. We can define another metric on \mathbb{R}^2 by putting

$$d^*(\langle a_1, a_2 \rangle, \langle b_1, b_2 \rangle) = \max\{|a_1 - b_1|, |a_2 - b_2|\}$$

where $\max\{x, y\}$ equals the larger of the two numbers x and y .

□

6.1.8 Example. Yet another metric on \mathbb{R}^2 is given by

$$d_1(\langle a_1, a_2 \rangle, \langle b_1, b_2 \rangle) = |a_1 - b_1| + |a_2 - b_2|.$$

□

A rich source of examples of metric spaces is the family of normed vector spaces.

6.1.9 Example. Let V be a vector space over the field of real or complex numbers. A **norm** $\| \cdot \|$ on V is a map $\| \cdot \| : V \rightarrow \mathbb{R}$ such that for all $a, b \in V$ and λ in the field

$$(i) \quad \| a \| \geq 0 \text{ and } \| a \| = 0 \text{ if and only if } a = 0,$$

$$(ii) \quad \| a + b \| \leq \| a \| + \| b \|, \text{ and}$$

$$(iii) \quad \| \lambda a \| = |\lambda| \| a \|.$$

A **normed vector space** $(V, \| \cdot \|)$ is a vector space V with a norm $\| \cdot \|$.

Let $(V, \| \cdot \|)$ be any normed vector space. Then there is a corresponding metric, d , on the set V given by $d(a, b) = \| a - b \|$, for a and b in V .

It is easily checked that d is indeed a metric. So **every normed vector space is also a metric space** in a natural way.

For example, \mathbb{R}^3 is a normed vector space if we put

$$\| \langle x_1, x_2, x_3 \rangle \| = \sqrt{x_1^2 + x_2^2 + x_3^2}, \quad \text{for } x_1, x_2, \text{ and } x_3 \text{ in } \mathbb{R}.$$

So \mathbb{R}^3 becomes a metric space if we put

$$\begin{aligned} d(\langle a_1, b_1, c_1 \rangle, \langle a_2, b_2, c_2 \rangle) &= \| (a_1 - a_2, b_1 - b_2, c_1 - c_2) \| \\ &= \sqrt{(a_1 - a_2)^2 + (b_1 - b_2)^2 + (c_1 - c_2)^2}. \end{aligned}$$

Indeed \mathbb{R}^n , for any positive integer n , is a normed vector space if we put

$$\| \langle x_1, x_2, \dots, x_n \rangle \| = \sqrt{x_1^2 + x_2^2 + \dots + x_n^2}.$$

So \mathbb{R}^n becomes a metric space if we put

$$\begin{aligned} d(\langle a_1, a_2, \dots, a_n \rangle, \langle b_1, b_2, \dots, b_n \rangle) &= \| \langle a_1 - b_1, a_2 - b_2, \dots, a_n - b_n \rangle \| \\ &= \sqrt{(a_1 - b_1)^2 + (a_2 - b_2)^2 + \dots + (a_n - b_n)^2}. \quad \square \end{aligned}$$

In a normed vector space $(N, \| \cdot \|)$ the **open ball with centre a and radius r** is defined to be the set

$$B_r(a) = \{x : x \in N \text{ and } \|x - a\| < r\}.$$

This suggests the following definition for metric spaces:

6.1.10 Definition. Let (X, d) be a metric space and r any positive real number. Then the **open ball about $a \in X$ of radius r** is the set $B_r(a) = \{x : x \in X \text{ and } d(a, x) < r\}$.

6.1.11 Example. In \mathbb{R} with the euclidean metric $B_r(a)$ is the open interval $(a - r, a + r)$. \square

6.1.12 Example. In \mathbb{R}^2 with the euclidean metric, $B_r(a)$ is the open disc with centre a and radius r .

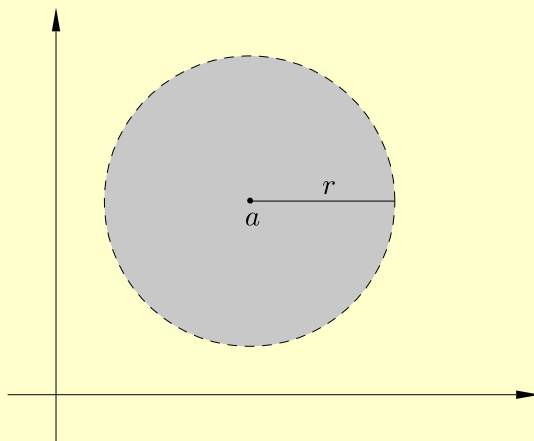
 \square

6.1.13 Example. In \mathbb{R}^2 with the metric d^* given by

$$d^*(\langle a_1, a_2 \rangle, \langle b_1, b_2 \rangle) = \max\{|a_1 - b_1|, |a_2 - b_2|\},$$

the open ball $B_1(\langle 0, 0 \rangle)$ looks like

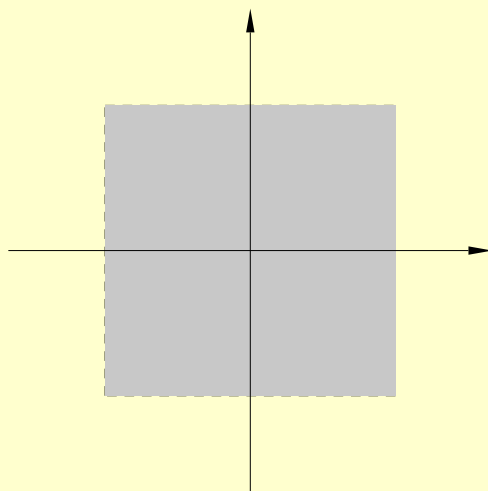

□

6.1.14 Example. In \mathbb{R}^2 with the metric d_1 given by

$$d_1(\langle a_1, a_2 \rangle, \langle b_1, b_2 \rangle) = |a_1 - b_1| + |a_2 - b_2|,$$

the open ball $B_1(\langle 0, 0 \rangle)$ looks like

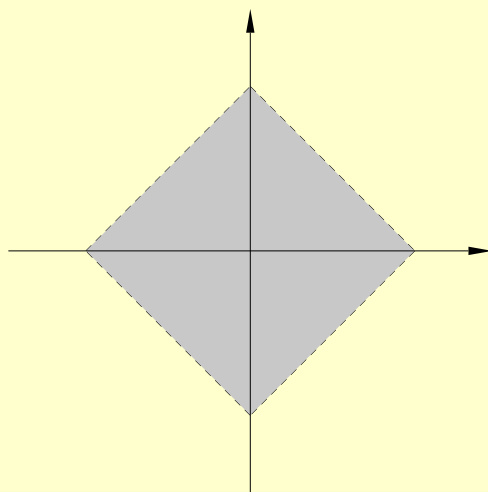

□

The proof of the following Lemma is quite easy (especially if you draw a diagram) and so is left for you to supply.

6.1.15 Lemma. Let (X, d) be a metric space and a and b points of X . Further, let δ_1 and δ_2 be positive real numbers. If $c \in B_{\delta_1}(a) \cap B_{\delta_2}(b)$, then there exists a $\delta > 0$ such that $B_\delta(c) \subseteq B_{\delta_1}(a) \cap B_{\delta_2}(b)$. \square

The next Corollary follows in a now routine way from Lemma 6.1.15.

6.1.16 Corollary. Let (X, d) be a metric space and B_1 and B_2 open balls in (X, d) . Then $B_1 \cap B_2$ is a union of open balls in (X, d) . \square

Finally we are able to link metric spaces with topological spaces.

6.1.17 Proposition. Let (X, d) be a metric space. Then the collection of open balls in (X, d) is a basis for a topology \mathcal{T} on X .

[The topology \mathcal{T} is referred to as **the topology induced by the metric d** , and (X, \mathcal{T}) is called **the induced topological space** or **the corresponding topological space** or the **associated topological space**.]

Proof. This follows from Proposition 2.2.8 and Corollary 6.1.16. \square

6.1.18 Example. If d is the euclidean metric on \mathbb{R} then a basis for the topology \mathcal{T} induced by the metric d is the set of all open balls. But $B_\delta(a) = (a - \delta, a + \delta)$. From this it is readily seen that \mathcal{T} is the euclidean topology on \mathbb{R} . So **the euclidean metric on \mathbb{R} induces the euclidean topology on \mathbb{R}** . \square

6.1.19 Example. From Exercises 2.3 #1 (ii) and Example 6.1.12, it follows that the euclidean metric on the set \mathbb{R}^2 induces the euclidean topology on \mathbb{R}^2 . \square

6.1.20 Example. From Exercises 2.3 #1 (i) and Example 6.1.13 it follows that the metric d^* also induces the euclidean topology on the set \mathbb{R}^2 . \square

It is left as an exercise for you to prove that the metric d_1 of Example 6.1.14 also induces the euclidean topology on \mathbb{R}^2 .

6.1.21 Example. If d is the discrete metric on a set X then for each $x \in X$, $B_{\frac{1}{2}}(x) = \{x\}$. So all the singleton sets are open in the topology \mathcal{T} induced on X by d . Consequently, \mathcal{T} is the discrete topology. \square

We saw in Examples 6.1.19, 6.1.20, and 6.1.14 three different metrics on the same set which induce the same topology.

6.1.22 Definition. Metrics on a set X are said to be **equivalent** if they induce the same topology on X .

So the metrics d , d^* , and d_1 , of Examples 6.1.3, 6.1.13, and 6.1.14 on \mathbb{R}^2 are equivalent.

6.1.23 Proposition. Let (X, d) be a metric space and \mathcal{T} the topology induced on X by the metric d . Then a subset U of X is open in (X, \mathcal{T}) if and only if for each $a \in U$ there exists an $\varepsilon > 0$ such that the open ball $B_\varepsilon(a) \subseteq U$.

Proof. Assume that $U \in \mathcal{T}$. Then, by Propositions 2.3.2 and 6.1.17, for any $a \in U$ there exists a point $b \in X$ and a $\delta > 0$ such that

$$a \in B_\delta(b) \subseteq U.$$

Let $\varepsilon = \delta - d(a, b)$. Then it is readily seen that

$$a \in B_\varepsilon(a) \subseteq U.$$

Conversely, assume that U is a subset of X with the property that for each $a \in U$ there exists an $\varepsilon_a > 0$ such that $B_{\varepsilon_a}(a) \subseteq U$. Then, by Propositions 2.3.3 and 6.1.17, U is an open set. \square

We have seen that every metric on a set X induces a topology on the set X . However, we shall now show that not every topology on a set is induced by a metric. First, a definition which you have already met in the exercises. (See Exercises 4.1 #13.)

6.1.24 Definition. A topological space (X, \mathcal{T}) is said to be a **Hausdorff space** (or a **T_2 -space**) if for each pair of distinct points a and b in X , there exist open sets U and V such that $a \in U$, $b \in V$, and $U \cap V = \emptyset$.

Of course \mathbb{R} , \mathbb{R}^2 and all discrete spaces are examples of Hausdorff spaces, while any set with at least 2 elements and which has the indiscrete topology is not a Hausdorff space. With a little thought we see that \mathbb{Z} with the finite-closed topology is also not a Hausdorff space. (Convince yourself of all of these facts.)

6.1.25 Proposition. Let (X, d) be any metric space and \mathcal{T} the topology induced on X by d . Then (X, \mathcal{T}) is a Hausdorff space.

Proof. Let a and b be any points of X , with $a \neq b$. Then $d(a, b) > 0$. Put $\varepsilon = d(a, b)$. Consider the open balls $B_{\varepsilon/2}(a)$ and $B_{\varepsilon/2}(b)$. Then these are open sets in (X, \mathcal{T}) with $a \in B_{\varepsilon/2}(a)$ and $b \in B_{\varepsilon/2}(b)$. So to show \mathcal{T} is Hausdorff we have to prove only that $B_{\varepsilon/2}(a) \cap B_{\varepsilon/2}(b) = \emptyset$.

Suppose $x \in B_{\varepsilon/2}(a) \cap B_{\varepsilon/2}(b)$. Then $d(x, a) < \frac{\varepsilon}{2}$ and $d(x, b) < \frac{\varepsilon}{2}$. Hence

$$\begin{aligned} d(a, b) &\leq d(a, x) + d(x, b) \\ &< \frac{\varepsilon}{2} + \frac{\varepsilon}{2} = \varepsilon. \end{aligned}$$

This says $d(a, b) < \varepsilon$, which is false. Consequently there exists no x in $B_{\varepsilon/2}(a) \cap B_{\varepsilon/2}(b)$; that is, $B_{\varepsilon/2}(a) \cap B_{\varepsilon/2}(b) = \emptyset$, as required. □

6.1.26 Remark. Putting Proposition 6.1.25 together with the comments which preceded it, we see that an indiscrete space with at least two points has a topology which is not induced by any metric. Also \mathbb{Z} with the finite-closed topology \mathcal{T} is such that \mathcal{T} is not induced by any metric on \mathbb{Z} . □

6.1.27 Definition. A space (X, \mathcal{T}) is said to be **metrizable** if there exists a metric d on the set X with the property that \mathcal{T} is the topology induced by d .

So, for example, the set \mathbb{Z} with the finite-closed topology is not a metrizable space.

Warning. One should not be misled by Proposition 6.1.25 into thinking that every Hausdorff space is metrizable. Later on we shall be able to produce (using infinite products) examples of Hausdorff spaces which are not metrizable. [Metrizability of topological spaces is quite a technical topic. For necessary and sufficient conditions for metrizability see Theorem 9.1, page 195, of the book Dugundji [66].]

Exercises 6.1

1. Prove that the metric d_1 of Example 6.1.8 induces the euclidean topology on \mathbb{R}^2 .
2. Let d be a metric on a non-empty set X .
 - (i) Show that the function e defined by $e(a, b) = \min\{1, d(a, b)\}$ where $a, b \in X$, is also a metric on X .
 - (ii) Prove that d and e are equivalent metrics.
 - (iii) A metric space (X, d) is said to be **bounded**, and d is said to be a **bounded metric**, if there exists a positive real number M such that $d(x, y) < M$, for all $x, y \in X$. Using (ii) deduce that every metric is equivalent to a bounded metric.
3. (i) Let d be a metric on a non-empty set X . Show that the function e defined by

$$e(a, b) = \frac{d(a, b)}{1 + d(a, b)}$$

where $a, b \in X$, is also a metric on X .

- (ii) Prove that d and e are equivalent metrics.

4. Let d_1 and d_2 be metrics on sets X and Y respectively. Prove that

(i) d is a metric on $X \times Y$, where

$$d(\langle x_1, y_1 \rangle, \langle x_2, y_2 \rangle) = \max\{d_1(x_1, x_2), d_2(y_1, y_2)\}.$$

(ii) e is a metric on $X \times Y$, where

$$e(\langle x_1, y_1 \rangle, \langle x_2, y_2 \rangle) = d_1(x_1, x_2) + d_2(y_1, y_2).$$

(iii) d and e are equivalent metrics.

5. Let (X, d) be a metric space and \mathcal{T} the corresponding topology on X . Fix $a \in X$. Prove that the map $f : (X, \mathcal{T}) \rightarrow \mathbb{R}$ defined by $f(x) = d(a, x)$ is continuous.

6. Let (X, d) be a metric space and \mathcal{T} the topology induced on X by d . Let Y be a subset of X and d_1 the metric on Y obtained by restricting d ; that is, $d_1(a, b) = d(a, b)$ for all a and b in Y . If \mathcal{T}_1 is the topology induced on Y by d_1 and \mathcal{T}_2 is the subspace topology on Y (induced by \mathcal{T} on X), prove that $\mathcal{T}_1 = \mathcal{T}_2$. [This shows that [every subspace of a metrizable space is metrizable.](#)]

7. (i) Let ℓ_1 be the set of all sequences of real numbers

$$x = (x_1, x_2, \dots, x_n, \dots)$$

with the property that the series $\sum_{n=1}^{\infty} |x_n|$ is convergent. If we define

$$d_1(x, y) = \sum_{n=1}^{\infty} |x_n - y_n|$$

for all x and y in ℓ_1 , prove that (ℓ_1, d_1) is a metric space.

- (ii) Let ℓ_2 be the set of all sequences of real numbers

$$x = (x_1, x_2, \dots, x_n, \dots)$$

with the property that the series $\sum_{n=1}^{\infty} x_n^2$ is convergent. If we define

$$d_2(x, y) = \left(\sum_{n=1}^{\infty} |x_n - y_n|^2 \right)^{\frac{1}{2}}$$

for all x and y in ℓ_2 , prove that (ℓ_2, d_2) is a metric space.

- (iii) Let ℓ_{∞} denote the set of bounded sequences of real numbers $x = (x_1, x_2, \dots, x_n, \dots)$.

If we define

$$d_{\infty}(x, y) = \sup\{|x_n - y_n| : n \in \mathbb{N}\}$$

where $x, y \in \ell_{\infty}$, prove that $(\ell_{\infty}, d_{\infty})$ is a metric space.

- (iv) Let c_0 be the subset of ℓ_{∞} consisting of all those sequences which converge to zero and let d_0 be the metric on c_0 obtained by restricting the metric d_{∞} on ℓ_{∞} as in Exercise 6. Prove that c_0 is a closed subset of $(\ell_{\infty}, d_{\infty})$.

- (v) Prove that each of the spaces (ℓ_1, d_1) , (ℓ_2, d_2) , and (c_0, d_0) is a separable space.

- (vi)* Is $(\ell_{\infty}, d_{\infty})$ a separable space?

- (vii) Show that each of the above metric spaces is a normed vector space in a natural way.

8. Let f be a continuous mapping of a metrizable space (X, \mathcal{T}) onto a topological space (Y, \mathcal{T}_1) . Is (Y, \mathcal{T}_1) necessarily metrizable? (Justify your answer.)

9. A topological space (X, \mathcal{T}) is said to be a **normal space** if for each pair of disjoint closed sets A and B , there exist open sets U and V such that $A \subseteq U$, $B \subseteq V$, and $U \cap V = \emptyset$. Prove that

(i) Every metrizable space is a normal space.

(ii) Every space which is both a T_1 -space and a normal space is a Hausdorff space. [A normal space which is also Hausdorff is called a **T_4 -space**.]

10. Let (X, d) and (Y, d_1) be metric spaces. Then (X, d) is said to be **isometric** to (Y, d_1) if there exists a surjective mapping $f : (X, d) \rightarrow (Y, d_1)$ such that for all x_1 and x_2 in X ,

$$d(x_1, x_2) = d_1(f(x_1), f(x_2)).$$

Such a mapping f is said to be an **isometry**. Prove that every isometry is a homeomorphism of the corresponding topological spaces. (So **isometric metric spaces are homeomorphic!**)

11. A topological space (X, \mathcal{T}) is said to satisfy the **first axiom of countability** or be **first countable** if for each $x \in X$ there exists a countable family $\{U_i(x)\}$ of open sets containing x with the property that every open set V containing x has (at least) one of the $U_i(x)$ as a subset. The countable family $\{U_i(x)\}$ is said to be a **countable base** at x . Prove the following:

(i) Every metrizable space satisfies the first axiom of countability.

(ii) Every topological space satisfying the second axiom of countability also satisfies the first axiom of countability.

12. Let X be the set $(\mathbb{R} \setminus \mathbb{N}) \cup \{1\}$. Define a function $f : \mathbb{R} \rightarrow X$ by

$$f(x) = \begin{cases} x, & \text{if } x \in \mathbb{R} \setminus \mathbb{N} \\ 1, & \text{if } x \in \mathbb{N}. \end{cases}$$

Further, define a topology \mathcal{T} on X by

$$\mathcal{T} = \{U : U \subseteq X \text{ and } f^{-1}(U) \text{ is open in the euclidean topology on } \mathbb{R}.\}$$

Prove the following:

- (i) f is continuous.
- (ii) Every open neighbourhood of 1 in (X, \mathcal{T}) is of the form $(U \setminus \mathbb{N}) \cup \{1\}$, where U is open in \mathbb{R} .
- (iii) (X, \mathcal{T}) is not first countable.

[Hint. Suppose $(U_1 \setminus \mathbb{N}) \cup \{1\}, (U_2 \setminus \mathbb{N}) \cup \{1\}, \dots, (U_n \setminus \mathbb{N}) \cup \{1\}, \dots$ is a countable base at 1. Show that for each positive integer n , we can choose $x_n \in U_n \setminus \mathbb{N}$ such that $x_n > n$. Verify that the set $U = \mathbb{R} \setminus \bigcup_{n=1}^{\infty} \{x_n\}$ is open in \mathbb{R} . Deduce that $V = (U \setminus \mathbb{N}) \cup \{1\}$ is an open neighbourhood of 1 which contains none of the sets $(U_n \setminus \mathbb{N}) \cup \{1\}$, which is a contradiction. So (X, \mathcal{T}) is not first countable.]

- (iv) (X, \mathcal{T}) is a Hausdorff space.
- (v) A Hausdorff continuous image of \mathbb{R} is not necessarily first countable.

13. A subset S of a metric space (X, d) is said to be **totally bounded** if for each $\varepsilon > 0$, there exist x_1, x_2, \dots, x_n in X , such that $S \subseteq \bigcup_{i=1}^n B_\varepsilon(x_i)$; that is, S can be covered by a finite number of open balls of radius ε .
- (i) Show that every totally bounded metric space is a bounded metric space. (See Exercise 2 above.)
 - (ii) Prove that \mathbb{R} with the euclidean metric is not totally bounded, but for each $a, b \in \mathbb{R}$ with $a < b$, the closed interval $[a, b]$ is totally bounded.
 - (iii) Let (Y, d) be a subspace of the metric space (X, d_1) with the induced metric. If (X, d_1) is totally bounded, then (Y, d) is totally bounded; that is, **every subspace of a totally bounded metric space is totally bounded**.
[Hint. Assume $X = \bigcup_{i=1}^n B_\varepsilon(x_i)$. If $y_i \in B_\varepsilon(x_i) \cap Y$, then by the triangle inequality $B_\varepsilon(x_i) \subseteq B_{2\varepsilon}(y_i)$.]
 - (iv) From (iii) and (ii) deduce that the totally bounded metric space $(0, 1)$ is homeomorphic to \mathbb{R} which is not totally bounded. Thus “totally bounded” is not a topological property.
 - (v) From (iii) and (ii) deduce that for each $n > 1$, \mathbb{R}^n with the euclidean metric is not totally bounded.
 - (vi) Noting that for each $a, b \in \mathbb{R}$, the closed interval is totally bounded, show that a metric subspace of \mathbb{R} is bounded if and only if it is totally bounded.
 - (vii) Show that for each $n > 1$, a metric subspace of \mathbb{R}^n is bounded if and only if it is totally bounded.
14. Show that every totally bounded metric space is separable. (See Exercise 13 above and Exercises 3.2#4.)

15. A topological space (X, \mathcal{T}) is said to be **locally euclidean** if there exists a positive integer n such that each point $x \in X$ has an open neighbourhood homeomorphic to an open ball about 0 in \mathbb{R}^n with the euclidean metric. A Hausdorff locally euclidean space is said to be a **topological manifold**.¹
- (i) Prove that every non-trivial interval (a, b) , $a, b \in \mathbb{R}$, is locally euclidean.
 - (ii) Let \mathbb{T} be the subset of the complex plane consisting of those complex numbers of modulus one. Identify the complex plane with \mathbb{R}^2 and let \mathbb{T} have the subspace topology. Show that the space \mathbb{T} is locally euclidean.
 - (iii) Show that every topological space locally homeomorphic to \mathbb{R}^n , for any positive integer n , is locally euclidean. (See Exercises 4.3 #9.)
 - (iv)* Find an example of a locally euclidean space which is not a topological manifold.

¹There are different definitions of topological manifold in the literature (cf. Kunen and Vaughan [139]; Lee [142]). In particular some definitions require the space to be connected – what we call a **connected manifold** – and older definitions require the space to be metrizable. A Hausdorff space in which each point has an open neighbourhood homeomorphic either to \mathbb{R}^n or to the closed half-space $\{ \langle x_1, x_2, \dots, x_n \rangle : x_i \geq 0, i = 1, 2, \dots, n \}$ of \mathbb{R}^n , for some positive integer n , is said to be a **topological manifold with boundary**. There is a large literature on manifolds with more structure, especially **differentiable manifolds** (Gadea and Masque [85]; Barden and Thomas [19]), **smooth manifolds** (Lee [143]) and **Riemannian manifolds** or **Cauchy-Riemann manifolds** or **CR-manifolds**.

6.2 Convergence of Sequences

You are familiar with the notion of a convergent sequence of real numbers. It is defined as follows. The sequence $x_1, x_2, \dots, x_n, \dots$ of real numbers is said to **converge** to the real number x if given any $\varepsilon > 0$ there exists an integer n_0 such that for all $n \geq n_0$, $|x_n - x| < \varepsilon$.

It is obvious how this definition can be extended from \mathbb{R} with the euclidean metric to any metric space.

6.2.1 Definitions. Let (X, d) be a metric space and x_1, \dots, x_n, \dots a sequence of points in X . Then the sequence is said to **converge to** $x \in X$ if given any $\varepsilon > 0$ there exists an integer n_0 such that for all $n \geq n_0$, $d(x, x_n) < \varepsilon$. This is denoted by $x_n \rightarrow x$. The sequence $y_1, y_2, \dots, y_n, \dots$ of points in (X, d) is said to be **convergent** if there exist a point $y \in X$ such that $y_n \rightarrow y$.

The next Proposition is easily proved, so its proof is left as an exercise.

6.2.2 Proposition. Let $x_1, x_2, \dots, x_n, \dots$ be a sequence of points in a metric space (X, d) . Further, let x and y be points in (X, d) such that $x_n \rightarrow x$ and $x_n \rightarrow y$. Then $x = y$. \square

For convenience we say that a subset A of a metric space (X, d) is closed (respectively, open) in the metric space (X, d) if it is closed (respectively, open) in the topology \mathcal{T} induced on X by the metric d .

The following proposition tells us the surprising fact that the topology of a metric space can be described entirely in terms of its convergent sequences.

6.2.3 Proposition. Let (X, d) be a metric space. A subset A of X is closed in (X, d) if and only if every convergent sequence of points in A converges to a point in A . (In other words, A is closed in (X, d) if and only if $a_n \rightarrow x$, where $x \in X$ and $a_n \in A$ for all n , implies $x \in A$.)

Proof. Assume that A is closed in (X, d) and let $a_n \rightarrow x$, where $a_n \in A$ for all positive integers n . Suppose that $x \in X \setminus A$. Then, as $X \setminus A$ is an open set containing x , there exists an open ball $B_\varepsilon(x)$ such that $x \in B_\varepsilon(x) \subseteq X \setminus A$. Noting that each $a_n \in A$, this implies that $d(x, a_n) > \varepsilon$ for each n . Hence the sequence $a_1, a_2, \dots, a_n, \dots$ does not converge to x . This is a contradiction. So $x \in A$, as required.

Conversely, assume that every convergent sequence of points in A converges to a point of A . Suppose that $X \setminus A$ is not open. Then there exists a point $y \in X \setminus A$ such that for each $\varepsilon > 0$, $B_\varepsilon(y) \cap A \neq \emptyset$. For each positive integer n , let x_n be any point in $B_{1/n}(y) \cap A$. Then we claim that $x_n \rightarrow y$. To see this let ε be any positive real number, and n_0 any integer greater than $1/\varepsilon$. Then for each $n \geq n_0$,

$$x_n \in B_{1/n}(y) \subseteq B_{1/n_0}(y) \subseteq B_\varepsilon(y).$$

So $x_n \rightarrow y$ and, by our assumption, $y \in A$. This is a contradiction and so $X \setminus A$ is open and thus A is closed in (X, d) . □

Having seen that the topology of a metric space can be described in terms of convergent sequences, we should not be surprised that continuous functions can also be so described.

6.2.4 Proposition. Let (X, d) and (Y, d_1) be metric spaces and f a mapping of X into Y . Let \mathcal{T} and \mathcal{T}_1 be the topologies determined by d and d_1 , respectively. Then $f : (X, \mathcal{T}) \rightarrow (Y, \mathcal{T}_1)$ is continuous if and only if $x_n \rightarrow x \Rightarrow f(x_n) \rightarrow f(x)$; that is, if $x_1, x_2, \dots, x_n, \dots$ is a sequence of points in (X, d) converging to x , then the sequence of points $f(x_1), f(x_2), \dots, f(x_n), \dots$ in (Y, d_1) converges to $f(x)$.

Proof. Assume that $x_n \rightarrow x \Rightarrow f(x_n) \rightarrow f(x)$. To verify that f is continuous it suffices to show that the inverse image of every closed set in (Y, \mathcal{T}_1) is closed in (X, \mathcal{T}) . So let A be closed in (Y, \mathcal{T}_1) . Let $x_1, x_2, \dots, x_n, \dots$ be a sequence of points in $f^{-1}(A)$ convergent to a point $x \in X$. As $x_n \rightarrow x$, $f(x_n) \rightarrow f(x)$. But since each $f(x_n) \in A$ and A is closed, Proposition 6.2.3 then implies that $f(x) \in A$. Thus $x \in f^{-1}(A)$. So we have shown that every convergent sequence of points from $f^{-1}(A)$ converges to a point of $f^{-1}(A)$. Thus $f^{-1}(A)$ is closed, and hence f is continuous.

Conversely, let f be continuous and $x_n \rightarrow x$. Let ε be any positive real number. Then the open ball $B_\varepsilon(f(x))$ is an open set in (Y, \mathcal{T}_1) . As f is continuous, $f^{-1}(B_\varepsilon(f(x)))$ is an open set in (X, \mathcal{T}) and it contains x . Therefore there exists a $\delta > 0$ such that

$$x \in B_\delta(x) \subseteq f^{-1}(B_\varepsilon(f(x))).$$

As $x_n \rightarrow x$, there exists a positive integer n_0 such that for all $n \geq n_0$, $x_n \in B_\delta(x)$. Therefore

$$f(x_n) \in f(B_\delta(x)) \subseteq B_\varepsilon(f(x)), \text{ for all } n \geq n_0.$$

Thus $f(x_n) \rightarrow f(x)$. □

The Corollary below is easily deduced from Proposition 6.2.4.

6.2.5 Corollary. Let (X, d) and (Y, d_1) be metric spaces, f a mapping of X into Y , and \mathcal{T} and \mathcal{T}_1 the topologies determined by d and d_1 , respectively. Then $f : (X, \mathcal{T}) \rightarrow (Y, \mathcal{T}_1)$ is continuous if and only if for each $x_0 \in X$ and $\varepsilon > 0$, there exists a $\delta > 0$ such that $x \in X$ and $d(x, x_0) < \delta \Rightarrow d_1(f(x), f(x_0)) < \varepsilon$. □

Exercises 6.2

1. Let $C[0, 1]$ and d be as in Example 6.1.5. Define a sequence of functions $f_1, f_2, \dots, f_n, \dots$ in $(C[0, 1], d)$ by

$$f_n(x) = \frac{\sin(nx)}{n}, \quad n = 1, 2, \dots, \quad x \in [0, 1].$$

Verify that $f_n \rightarrow f_0$, where $f_0(x) = 0$, for all $x \in [0, 1]$.

2. Let (X, d) be a metric space and $x_1, x_2, \dots, x_n, \dots$ a sequence such that $x_n \rightarrow x$ and $x_n \rightarrow y$. Prove that $x = y$.
3. (i) Let (X, d) be a metric space, \mathcal{T} the induced topology on X , and $x_1, x_2, \dots, x_n, \dots$ a sequence of points in X . Prove that $x_n \rightarrow x$ if and only if for every open set $U \ni x$, there exists a positive integer n_0 such that $x_n \in U$ for all $n \geq n_0$.
- (ii) Let X be a set and d and d_1 equivalent metrics on X . Deduce from (i) that if $x_n \rightarrow x$ in (X, d) , then $x_n \rightarrow x$ in (X, d_1) .
4. Write a proof of Corollary 6.2.5.
5. Let (X, \mathcal{T}) be a topological space and let $x_1, x_2, \dots, x_n, \dots$ be a sequence of points in X . We say that $x_n \rightarrow x$ if for each open set $U \ni x$ there exists a positive integer n_0 , such that $x_n \in U$ for all $n \geq n_0$. Find an example of a topological space and a sequence such that $x_n \rightarrow x$ and $x_n \rightarrow y$ but $x \neq y$.
6. (i) Let (X, d) be a metric space and $x_n \rightarrow x$ where each $x_n \in X$ and $x \in X$. Let A be the subset of X which consists of x and all of the points x_n . Prove that A is closed in (X, d) .
- (ii) Deduce from (i) that the set $\{2\} \cup \{2 - \frac{1}{n} : n = 1, 2, \dots\}$ is closed in \mathbb{R} .
- (iii) Verify that the set $\{2 - \frac{1}{n} : n = 1, 2, \dots\}$ is not closed in \mathbb{R} .

7. (i) Let d_1, d_2, \dots, d_m be metrics on a set X and a_1, a_2, \dots, a_m positive real numbers. Prove that d is a metric on X , where d is defined by

$$d(x, y) = \sum_{i=1}^m a_i d_i(x, y), \text{ for all } x, y \in X.$$

- (ii) If $x \in X$ and $x_1, x_2, \dots, x_n, \dots$ is a sequence of points in X such that $x_n \rightarrow x$ in each metric space (X, d_i) prove that $x_n \rightarrow x$ in the metric space (X, d) .

8. Let X, Y, d_1, d_2 and d be as in Exercises 6.1 #4. If $x_n \rightarrow x$ in (X, d_1) and $y_n \rightarrow y$ in (Y, d_2) , prove that

$$\langle x_n, y_n \rangle \rightarrow \langle x, y \rangle \text{ in } (X \times Y, d).$$

9. Let A and B be non-empty sets in a metric space (X, d) . Define

$$\rho(A, B) = \inf\{d(a, b) : a \in A, b \in B\}.$$

$[\rho(A, B)$ is referred to as the **distance between the sets A and B .**]

- (i) If S is any non-empty subset of (X, d) , prove that $\bar{S} = \{x : x \in X \text{ and } \rho(\{x\}, S) = 0\}$.
(ii) If S is any non-empty subset of (X, d) then the function $f : (X, d) \rightarrow \mathbb{R}$ defined by

$$f(x) = \rho(\{x\}, S), \quad x \in X$$

is continuous.

10. (i) For each positive integer n let f_n be a continuous function of $[0, 1]$ into itself and let $a \in [0, 1]$ be such that $f_n(a) = a$, for all n . Further let f be a continuous function of $[0, 1]$ into itself. If $f_n \rightarrow f$ in $(C[0, 1], d^*)$ where d^* is the metric of Example 6.1.6, prove that a is also a fixed point of f .
(ii) Show that (i) would be false if d^* were replaced by the metric d , of Example 6.1.5.

6.3 Completeness

6.3.1 Definition. A sequence $x_1, x_2, \dots, x_n, \dots$ of points in a metric space (X, d) is said to be a **Cauchy sequence** if given any real number $\varepsilon > 0$, there exists a positive integer n_0 , such that for all integers $m \geq n_0$ and $n \geq n_0$, $d(x_m, x_n) < \varepsilon$.

6.3.2 Proposition. Let (X, d) be a metric space and $x_1, x_2, \dots, x_n, \dots$ a sequence of points in (X, d) . If there exists a point $a \in X$, such that the sequence converges to a , that is, $x_n \rightarrow a$, then the sequence is a Cauchy sequence.

Proof. Let ε be any positive real number. Put $\delta = \varepsilon/2$. As $x_n \rightarrow a$, there exists a positive integer n_0 , such that for all $n > n_0$, $d(x_n, a) < \delta$.

So let $m > n_0$ and $n > n_0$. Then $d(x_n, a) < \delta$ and $d(x_m, a) < \delta$.

By the triangle inequality for metrics,

$$\begin{aligned} d(x_m, x_n) &\leq d(x_m, a) + d(x_n, a) \\ &< \delta + \delta \\ &= \varepsilon \end{aligned}$$

and so the sequence is indeed a Cauchy sequence. \square

This naturally leads us to think about the converse statement and to ask if every Cauchy sequence is a convergent sequence. The following example shows that this is not true.

6.3.3 Example. Consider the open interval $(0, 1)$ with the euclidean metric d . It is clear that the sequence $0.1, 0.01, 0.001, 0.0001, \dots$ is a Cauchy sequence but it does not converge to any point in $(0, 1)$. \square

6.3.4 Definition. A metric space (X, d) is said to be **complete** if every Cauchy sequence in (X, d) converges to a point in (X, d) .

We immediately see from Example 6.3.3 that the unit interval $(0, 1)$ with the euclidean metric is not a complete metric space. On the other hand, if X is any finite set and d is the discrete metric on X , then obviously (X, d) is a complete metric space.

We shall show that \mathbb{R} with the euclidean metric is a complete metric space. First we need to do some preparation.

As a shorthand, we shall denote the sequence $x_1, x_2, \dots, x_n, \dots$, by $\{x_n\}$.

6.3.5 Definition. If $\{x_n\}$ is any sequence, then the sequence x_{n_1}, x_{n_2}, \dots is said to be a **subsequence** if $n_1 < n_2 < n_3 < \dots$.

6.3.6 Definitions. Let $\{x_n\}$ be a sequence in \mathbb{R} . Then it is said to be an **increasing sequence** if $x_n \leq x_{n+1}$, for all $n \in \mathbb{N}$. It is said to be a **decreasing sequence** if $x_n \geq x_{n+1}$, for all $n \in \mathbb{N}$. A sequence which is either increasing or decreasing is said to be **monotonic**.

Most sequences are of course neither increasing nor decreasing.

6.3.7 Definition. Let $\{x_n\}$ be a sequence in \mathbb{R} . Then $n_0 \in \mathbb{N}$ is said to be a **peak point** if $x_n \leq x_{n_0}$, for every $n \geq n_0$.

6.3.8 Lemma. Let $\{x_n\}$ be any sequence in \mathbb{R} . Then $\{x_n\}$ has a monotonic subsequence.

Proof. Assume firstly that the sequence $\{x_n\}$ has an infinite number of peak points. Then choose a subsequence $\{x_{n_k}\}$, where each n_k is a peak point. This implies, in particular, that $x_{n_k} \geq x_{n_{k+1}}$, for each $k \in \mathbb{N}$; that is, $\{x_{n_k}\}$ is a decreasing subsequence of $\{x_n\}$; so it is a monotonic subsequence.

Assume then that there are only a finite number of peak points. So there exists an integer N , such that there are no peak points $n > N$. Choose any $n_1 > N$. Then n_1 is not a peak point. So there is an $n_2 > n_1$ with $x_{n_2} > x_{n_1}$. Now $n_2 > N$ and so it too is not a peak point. Hence there is an $n_3 > n_2$, with $x_{n_3} > x_{n_2}$. Continuing in this way (by mathematical induction), we produce a subsequence $\{x_{n_k}\}$ of $\{x_n\}$ with $x_{n_k} < x_{n_{k+1}}$, for all $k \in \mathbb{N}$; that is, $\{x_{n_k}\}$ is an increasing subsequence of $\{x_n\}$. This completes the proof of the Lemma. \square

6.3.9 Proposition. Let $\{x_n\}$ be a monotonic sequence in \mathbb{R} with the euclidean metric. Then $\{x_n\}$ converges to a point in \mathbb{R} if and only if $\{x_n\}$ is bounded.

Proof. Recall that “bounded” was defined in Remark 3.3.1.

Clearly if $\{x_n\}$ is unbounded, then it does not converge.

Assume then that $\{x_n\}$ is an increasing sequence which is bounded. By the Least Upper Bound Axiom, there is a least upper bound L of the set $\{x_n : n \in \mathbb{N}\}$. If ε is any positive real number, then there exists a positive integer N such that $d(x_N, L) < \varepsilon$; indeed, $x_N > L - \varepsilon$.

But as $\{x_n\}$ is an increasing sequence and L is an upper bound, we have

$$L - \varepsilon < x_n < L, \quad \text{for all } n > N.$$

That is $x_n \rightarrow L$.

The case that $\{x_n\}$ is a decreasing sequence which is bounded is proved in an analogous fashion, which completes the proof. \square

As a corollary to Lemma 6.3.8 and Proposition 6.3.9, we obtain immediately the following:

6.3.10 Theorem. (Bolzano-Weierstrass Theorem) Every bounded sequence in \mathbb{R} with the euclidean metric has a convergent subsequence. \square

At long last we are able to prove that \mathbb{R} with the euclidean metric is a complete metric space.

6.3.11 Corollary. The metric space \mathbb{R} with the euclidean metric is a complete metric space.

Proof. Let $\{x_n\}$ be any Cauchy sequence in (\mathbb{R}, d) .

If we show that this arbitrary Cauchy sequence converges in \mathbb{R} , we shall have shown that the metric space is complete. The first step will be to show that this sequence is bounded.

As $\{x_n\}$ is a Cauchy sequence, there exists a positive integer N , such that for any $n \geq N$ and $m \geq N$, $d(x_n, x_m) < 1$; that is, $|x_n - x_m| < 1$. Put $M = |x_1| + |x_2| + \cdots + |x_N| + 1$. Then $|x_n| < M$, for all $n \in \mathbb{N}$; that is, the sequence $\{x_n\}$ is bounded.

So by the Bolzano-Weierstrass Theorem 6.3.10, this sequence has a convergent subsequence; that is, there is an $a \in \mathbb{R}$ and a subsequence $\{x_{n_k}\}$ with $x_{n_k} \rightarrow a$.

We shall show that not only does the subsequence converge to a , but also that the sequence $\{x_n\}$ itself converges to a .

Let ε be any positive real number. As $\{x_n\}$ is a Cauchy sequence, there exists a positive integer N_0 such that

$$|x_n - x_m| < \frac{\varepsilon}{2}, \quad \text{for all } m \geq N_0 \text{ and } n \geq N_0.$$

Since $x_{n_k} \rightarrow a$, there exists a positive integer N_1 , such that

$$|x_{n_k} - a| < \frac{\varepsilon}{2}, \quad \text{for all } n_k \geq N_1.$$

So if we choose $N_2 = \max\{N_0, N_1\}$, combining the above two inequalities yields

$$\begin{aligned} |x_n - a| &\leq |x_n - x_{n_k}| + |x_{n_k} - a| \\ &< \frac{\varepsilon}{2} + \frac{\varepsilon}{2}, \quad \text{for } n > N_2 \text{ and } n_k > N_2 \\ &= \varepsilon. \end{aligned}$$

Hence $x_n \rightarrow a$, which completes the proof of the Corollary. \square

6.3.12 Corollary. For each positive integer m , the metric space \mathbb{R}^m with the euclidean metric is a complete metric space.

Proof. See Exercises 6.3#4. □

6.3.13 Proposition. Let (X, d) be a metric space, Y a subset of X , and d_1 the metric induced on Y by d .

- (i) If (X, d) is a complete metric space and Y is a closed subspace of (X, d) , then (Y, d_1) is a complete metric space.
- (ii) If (Y, d_1) is a complete metric space, then Y is a closed subspace of (X, d) .

Proof. See Exercises 6.3#5. □

6.3.14 Remark. Example 6.3.3 showed that $(0, 1)$ with the euclidean metric is not a complete metric space. However, Corollary 6.3.11 showed that \mathbb{R} with the euclidean metric is a complete metric space. And we know that the topological spaces $(0, 1)$ and \mathbb{R} are homeomorphic. So completeness is not preserved by homeomorphism and so is not a topological property.

6.3.15 Definition. A topological space (X, \mathcal{T}) is said to be **completely metrizable** if there exists a metric d on X such that \mathcal{T} is the topology on X determined by d and (X, d) is a complete metric space.

6.3.16 Remark. Note that being completely metrizable is indeed a topological property. Further, it is easy to verify (see Exercises 6.3#7) that every discrete space and every interval of \mathbb{R} with the induced topology is completely metrizable. So for $a, b \in \mathbb{R}$ with $a < b$, the topological spaces \mathbb{R} , $[a, b]$, (a, b) , $[a, b)$, $(a, b]$, $(-\infty, a)$, $(-\infty, a]$, (a, ∞) , $[a, \infty)$, and $\{a\}$ with their induced topologies are all completely metrizable. Somewhat surprisingly we shall see later that even the space \mathbb{P} of all irrational numbers with its induced topology is completely metrizable. Also as $(0, 1)$ is a completely metrizable subspace of \mathbb{R} which is not a closed subset, we see that Proposition 6.3.13(ii) would not be true if complete metric were replaced by completely metrizable. \square

6.3.17 Definition. A topological space is said to be **separable** if it has a countable dense subset.

It was seen in Exercises 3.2#4 that \mathbb{R} and every countable topological space is a separable space. Other examples are given in Exercises 6.1#7.

6.3.18 Definition. A topological space (X, \mathcal{T}) is said to be a **Polish space** if it is separable and completely metrizable.

It is clear that \mathbb{R} is a Polish space. By Exercises 6.3#6, \mathbb{R}^n is a Polish space, for each positive integer n .

6.3.19 Definition. A topological space (X, \mathcal{T}) is said to be a **Souslin space** if it is Hausdorff and a continuous image of a Polish space. If A is a subset of a topological space (Y, \mathcal{T}_1) such that with the induced topology \mathcal{T}_2 , the space (A, \mathcal{T}_2) is a Souslin space, then A is said to be an **analytic set** in (Y, \mathcal{T}_1) .

Obviously every Polish space is a Souslin space. Exercises 6.1#12 and #11 show that the converse is false as a Souslin space need not be metrizable. However, we shall see that even a metrizable Souslin space is not necessarily a Polish space. To see this we note that **every countable topological space is a Souslin space** as it is a continuous image of the discrete space \mathbb{N} ; one such space is the metrizable space \mathbb{Q} which we shall in Example 6.5.8 is not a Polish space.

We know that two topological spaces are equivalent if they are homeomorphic. It is natural to ask when are two metric spaces equivalent (as metric spaces)? The relevant concept was introduced in Exercises 6.1#10, namely that of isometric.

6.3.20 Definition. Let (X, d) and (Y, d_1) be metric spaces. Then (X, d) is said to be **isometric** to (Y, d_1) if there exists a surjective mapping $f : X \rightarrow Y$ such that for all x_1 and x_2 in X , $d(x_1, x_2) = d_1(f(x_1), f(x_2))$. Such a mapping f is said to be an **isometry**.

Let d be any metric on \mathbb{R} and a any positive real number. If d_1 is defined by $d_1(x, y) = a \cdot d(x, y)$, for all $x, y \in \mathbb{R}$, then it is easily shown that (\mathbb{R}, d_1) is a metric space isometric to (\mathbb{R}, d) .

It is also easy to verify that any two isometric metric spaces have their associated topological spaces homeomorphic and every isometry is also a homeomorphism of the associated topological spaces.

6.3.21 Definition. Let (X, d) and (Y, d_1) be metric spaces and f a mapping of X into Y . Let $Z = f(X)$, and d_2 be the metric induced on Z by d_1 . If $f : (X, d) \rightarrow (Z, d_2)$ is an isometry, then f is said to be an **isometric embedding** of (X, d) in (Y, d_1) .

Of course the natural embedding of \mathbb{Q} with the euclidean metric in \mathbb{R} with the euclidean metric is an isometric embedding. It is also the case that \mathbb{N} with the euclidean metric has a natural isometric embedding into both \mathbb{R} and \mathbb{Q} with the euclidean metric.

6.3.22 Definition. Let (X, d) and (Y, d_1) be metric spaces and f a mapping of X into Y . If (Y, d_1) is a complete metric space, $f : (X, d) \rightarrow (Y, d_1)$ is an isometric embedding and $f(X)$ is a dense subset of Y in the associated topological space, then (Y, d_1) is said to be a **completion** of (X, d) .

Clearly \mathbb{R} with the euclidean metric is a completion of \mathbb{Q} , the set of rationals with the euclidean metric. Also \mathbb{R} with the euclidean metric is a completion of \mathbb{P} , the set of irrationals with the euclidean metric.

Two questions immediately jump to mind: (1) Does every metric space have a completion? (2) Is the completion of a metric space unique in some sense? We shall see that the answer to both questions is “yes”.

6.3.23 Proposition. Let (X, d) be any metric space. Then (X, d) has a completion.

Outline Proof. We begin by saying that two Cauchy sequences $\{y_n\}$ and $\{z_n\}$ in (X, d) are equivalent if $d(y_n, z_n) \rightarrow 0$ in \mathbb{R} . This is indeed an equivalence relation; that is, it is reflexive, symmetric and transitive. Now let \tilde{X} be the set of all equivalence classes of equivalent Cauchy sequences in (X, d) . We wish to put a metric on \tilde{X} .

Let \tilde{y} and \tilde{z} be any two points in \tilde{X} . Let Cauchy sequences $\{y_n\} \in \tilde{y}$ and $\{z_n\} \in \tilde{z}$. Now the sequence $\{d(y_n, z_n)\}$ is a Cauchy sequence in \mathbb{R} . (See Exercises 6.3#8.) As \mathbb{R} is a complete metric space, this Cauchy sequence in \mathbb{R} converges to some number, which we shall denote by $d_1(\tilde{y}, \tilde{z})$. It is straightforward to show that $d_1(\tilde{y}, \tilde{z})$ is not dependent on the choice of the sequence $\{y_n\}$ in \tilde{y} and $\{z_n\}$ in \tilde{z} .

For each $x \in X$, the constant sequence x, x, \dots, x, \dots is a Cauchy sequence in (X, d) converging to x . Let \tilde{x} denote the equivalence class of all Cauchy sequences converging to $x \in X$. Define the subset Y of \tilde{X} to be $\{\tilde{x} : x \in X\}$. If d_2 is the metric on Y induced by the metric d_1 on \tilde{X} , then it is clear that the mapping $f : (X, d) \rightarrow (Y, d_2)$, given by $f(x) = \tilde{x}$, is an isometry.

Now we show that Y is dense in \tilde{X} . To do this we show that for any given real number $\varepsilon > 0$, and $z \in \tilde{X}$, there is an $\tilde{x} \in Y$, such that $d_1(z, \tilde{x}) < \varepsilon$. Note that z is an equivalence class of Cauchy sequences. Let $\{x_n\}$ be a Cauchy sequence in this equivalence class z . There exists a positive integer n_0 , such that for all $n > n_0$, $d_1(x_n, x_{n_0}) < \varepsilon$. We now consider the constant sequence $x_{n_0}, x_{n_0}, \dots, x_{n_0}, \dots$. This lies in the equivalence class \tilde{x}_{n_0} , which is in Y . Further, $d_1(\tilde{x}_{n_0}, z) < \varepsilon$. So Y is indeed dense in \tilde{X} .

Finally, we show that (\tilde{X}, d_1) is a complete metric space. Let $\{z_n\}$ be a Cauchy sequence in this space. We are required to show that it converges in \tilde{X} . As Y is dense, for each positive integer n , there exists $\tilde{x}_n \in Y$, such that $d_1(\tilde{x}_n, z_n) < 1/n$. We show that $\{\tilde{x}_n\}$ is a Cauchy sequence in Y .

Consider a real number $\varepsilon > 0$. There exists a positive integer N , such that $d_1(z_n, z_m) < \varepsilon/2$ for $n, m > N$. Now take a positive integer n_1 , with $1/n_1 < \varepsilon/4$. For $n, m > n_1 + N$, we have

$$d_1(\tilde{x}_n, \tilde{x}_m) < d_1(\tilde{x}_n, z_n) + d_1(z_n, z_m) + d_1(z_m, \tilde{x}_m) < 1/n + \varepsilon/2 + 1/m < \varepsilon.$$

So $\{\tilde{x}_n\}$ is a Cauchy sequence in Y . This implies that $\{x_n\}$ is a Cauchy sequence in (X, d) . Hence $\{x_n\} \in z$, for some $z \in \tilde{X}$. It is now straightforward to show first that $\tilde{x}_n \rightarrow z$ and then that

$z_n \rightarrow z$, which completes the proof. \square

6.3.24 Proposition. Let (A, d_1) and (B, d_2) be complete metric spaces. Let X be a subset of (A, d_1) with induced metric d_3 , and Y a subset of (B, d_2) with induced metric d_4 . Further, let X be dense in (A, d_1) and Y dense in (B, d_2) . If there is an isometry $f : (X, d_3) \rightarrow (Y, d_4)$, then there exists an isometry $g : (A, d_1) \rightarrow (B, d_2)$, such that $g(x) = f(x)$, for all $x \in X$.

Outline Proof. Let $a \in A$. As X is dense in (A, d_1) , there exists a sequence $x_n \rightarrow a$, where each $x_n \in X$. So $\{x_n\}$ is a Cauchy sequence. As f is an isometry, $\{f(x_n)\}$ is a Cauchy sequence in (Y, d_4) and hence also a Cauchy sequence in (B, d_2) . Since (B, d_2) is a complete metric space, there exists a $b \in B$, such that $f(x_n) \rightarrow b$. So we define $g(a) = b$.

To show that g is a well-defined map of A into B , it is necessary to verify that if $\{z_n\}$ is any other sequence in X converging to a , then $f(z_n) \rightarrow b$. This follows from the fact that $d_1(x_n, z_n) \rightarrow 0$ and thus $d_2(f(x_n), f(z_n)) = d_4(f(x_n), f(z_n)) \rightarrow 0$.

Next we need to show that $g : A \rightarrow B$ is one-to-one and onto. This is left as an exercise as it is routine.

Finally, let $a_1, a_2 \in A$ and $x_{1n} \rightarrow a_1$ and $x_{2n} \rightarrow a_2$, where each a_{1n} and each a_{2n} is in X . Then

$$d_1(a_1, a_2) = \lim_{n \rightarrow \infty} d_3(a_{1n}, a_{2n}) = \lim_{n \rightarrow \infty} d_4(f(a_{1n}), f(a_{2n})) = d_2(g(a_1), g(a_2))$$

and so g is indeed an isometry, as required. \square

Proposition 6.3.24 says that, up to isometry, the completion of a metric spaces is unique.

We conclude this section with another concept. Recall that in Example 6.1.9 we introduced the concept of a normed vector space. We now define a very important class of normed vector spaces.

6.3.25 Definition. Let $(N, \| \cdot \|)$ be a normed vector space and d the associated metric on the set N . Then $(N, \| \cdot \|)$ is said to be a **Banach space** if (N, d) is a complete metric space.

From Proposition 6.3.23 we know that every normed vector space has a completion. However, the rather pleasant feature is that this completion is in fact also a normed vector space and so is a Banach space. (See Exercises 6.3#12.)

Exercises 6.3

1. Verify that the sequence $\{x_n = \sum_{i=0}^n \frac{1}{i!}\}$ is a Cauchy sequence in \mathbb{Q} with the euclidean metric. [This sequence does not converge in \mathbb{Q} . In \mathbb{R} it converges to the number e , which is known to be irrational. For a proof that e is irrational, indeed transcendental, see Jones et al. [128].]
2. Prove that every subsequence of a Cauchy sequence is a Cauchy sequence.
3. Give an example of a sequence in \mathbb{R} with the euclidean metric which has no subsequence which is a Cauchy sequence.
4. Using Corollary 6.3.11, prove that, for each positive integer m , the metric space \mathbb{R}^m with the euclidean metric is a complete metric space.

[Hint. Let $\{\langle x_{1n}, x_{2n}, \dots, x_{mn} \rangle : n = 1, 2, \dots\}$ be a Cauchy sequence in \mathbb{R}^m . Prove that, for each $i = 1, 2, \dots, m$, the sequence $\{x_{in} : n = 1, 2, \dots\}$ in \mathbb{R} with the euclidean metric is a Cauchy sequence and so converges to a point a_i . Then show that the sequence $\{\langle x_{1n}, x_{2n}, \dots, x_{mn} \rangle : n = 1, 2, \dots\}$ converges to the point $\langle a_1, a_2, \dots, a_m \rangle$.]
5. Prove that every closed subspace of a complete metric space is complete and that every complete metric subspace of a metric space is closed.
6. Prove that for each positive integer n , \mathbb{R}^n is a Polish space.
7. Let $a, b \in \mathbb{R}$, with $a < b$. Prove that each discrete space and each of the spaces $[a, b]$, (a, b) , $[a, b)$, $(a, b]$, $(-\infty, a)$, $(-\infty, a]$, (a, ∞) , $[a, \infty)$, and $\{a\}$, with its induced topology is a Polish Space.
8. If (X, d) is a metric space and $\{x_n\}$ and $\{y_n\}$ are Cauchy sequences, prove that $\{d(x_n, y_n)\}$ is a Cauchy sequence in \mathbb{R} .

9. Fill in the missing details in the proof of Proposition 6.3.23.
10. Fill in the missing details in the proof of Proposition 6.3.24.
- 11*. Show that each of the spaces (ℓ_1, d_1) , (ℓ_2, d_2) , (c_0, d_0) , and (ℓ_∞, d_∞) of Exercises 6.1#7 is a complete metric space. Indeed, show that each of these spaces is a Banach space in a natural way.
- 12*. Let X be any normed vector space. Prove that it is possible to put a normed vector space structure on \tilde{X} , the complete metric space constructed in Proposition 6.3.23. So **every normed vector space has a completion which is a Banach space**.
13. Let (X, d) be a metric space and S a subset of X . Then the set S is said to be **bounded** if there exists a positive integer M such that $d(x, y) < M$, for all $x, y \in S$.
- (i) Show that if S is a bounded set in (X, d) and $S = X$, then (X, d) is a bounded metric space. (See Exercises 6.1# 2.)
- (ii) Let $a_1, a_2, \dots, a_n, \dots$ be a convergent sequence in a metric space (X, d) . If the set S consists of the (distinct) points in this sequence, show that S is a bounded set.
- (iii) Let $b_1, b_2, \dots, b_n, \dots$ be a Cauchy sequence in a complete metric space (X, d) . If T is the set of points in this sequence, show that T is a bounded set.
- (iv) Is (iii) above still true if we do not insist that (X, d) is complete?
14. Prove that a metric space (X, d) is separable if and only if the associated topological space (X, \mathcal{T}) satisfies the second axiom of countability. (See Exercises 2.2 #4.)
15. Deduce from Exercise 14 above that if (X, d) is a separable metric space, and d_1 is the metric induced on a subset Y of X by d , then (Y, d_1) is separable; in other words **every subspace of a separable metric space is separable**. (It should be noted that it is not necessarily true that a subspace of a separable topological space is separable.)

6.4 Contraction Mappings

In Chapter 5 we had our first glimpse of a fixed point theorem. In this section we shall meet another type of fixed point theorem. This section is very much part of metric space theory rather than general topology. Nevertheless the topic is important for applications.

6.4.1 Definition. Let f be a mapping of a set X into itself. Then a point $x \in X$ is said to be a **fixed point** of f if $f(x) = x$.

6.4.2 Definition. Let (X, d) be a metric space and f a mapping of X into itself. Then f is said to be a **contraction mapping** if there exists an $r \in (0, 1)$, such that

$$d(f(x_1), f(x_2)) \leq r \cdot d(x_1, x_2), \quad \text{for all } x_1, x_2 \in X.$$

6.4.3 Proposition. Let f be a contraction mapping of the metric space (X, d) . Then f is a continuous mapping.

Proof. See Exercises 6.4#1.

□

6.4.4 Theorem. (Contraction Mapping Theorem or Banach Fixed Point Theorem) Let (X, d) be a complete metric space and f a contraction mapping of (X, d) into itself. Then f has precisely one fixed point.

Proof. Let x be any point in X and consider the sequence

$$x, f(x), f^2(x) = f(f(x)), f^3(x) = f(f(f(x))), \dots, f^n(x), \dots$$

We shall show this is a Cauchy sequence. Put $a = d(x, f(x))$. As f is a contraction mapping, there exists $r \in (0, 1)$, such that $d(f(x_1), f(x_2)) \leq r.d(x_1, x_2)$, for all $x_1, x_2 \in X$.

Clearly $d(f(x), f^2(x)) \leq r.d(x, f(x)) = r.a$, $d(f^2(x), f^3(x)) \leq r^2.d(x, f(x)) = r^2.a$, and by induction we obtain that, for each $k \in \mathbb{N}$, $d(f^k(x), f^{k+1}(x)) \leq r^k.d(x, f(x)) = r^k.a$.

Let m and n be any positive integers, with $n > m$. Then

$$\begin{aligned} d(f^m(x), f^n(x)) &= d(f^m(x), f^m(f^{n-m}(x))) \\ &\leq r^m.d(x, f^{n-m}(x)) \\ &\leq r^m.[d(x, f(x)) + d(f(x), f^2(x)) + \dots + d(f^{n-m-1}(x), f^{n-m}(x))] \\ &\leq r^m.d(x, f(x))[1 + r + r^2 + \dots + r^{n-m-1}] \\ &\leq \frac{r^m.a}{1-r}. \end{aligned}$$

As $r < 1$, it is clear that $\{f^n(x)\}$ is a Cauchy sequence. Since (X, d) is complete, there is a $z \in X$, such that $f^n(x) \rightarrow z$.

By Proposition 6.4.3, f is continuous and so

$$f(z) = f\left(\lim_{n \rightarrow \infty} f^n(x)\right) = \lim_{n \rightarrow \infty} f^{n+1}(x) = z \quad (6.1)$$

and so z is indeed a fixed point of f .

Finally, let t be any fixed point of f . Then

$$d(t, z) = d(f(t), f(z)) \leq r.d(t, z). \quad (6.2)$$

As $r < 1$, this implies $d(t, z) = 0$ and thus $t = z$ and f has only one fixed point. \square

It is worth mentioning that the Contraction Mapping Theorem provides not only an existence proof of a fixed point but also a construction for finding it; namely, let x be any point in X and find the limit of the sequence $\{f^n(x)\}$. This method allows us to write a computer program to approximate the limit point to any desired accuracy.

Exercises 6.4

1. Prove Proposition 6.4.3.
2. Extend the Contraction Mapping Theorem by showing that if f is a mapping of a complete metric space (X, d) into itself and f^N is a contraction mapping for some positive integer N , then f has precisely one fixed point.
3. The Mean Value Theorem says: Let f be a real-valued function on a closed unit interval $[a, b]$ which is continuous on $[a, b]$ and differentiable on (a, b) . Then there exists a point $c \in [a, b]$ such that $f(b) - f(a) = f'(c)(b - a)$. (Recall that f is said to be **differentiable** at a point s if $\lim_{x \rightarrow s} \frac{f(x) - f(s)}{x - s} = f'(s)$ exists.)

Using the Mean Value Theorem prove the following:

Let $f : [a, b] \rightarrow [a, b]$ be differentiable. Then f is a contraction if and only if there exists $r \in (0, 1)$ such that $|f'(x)| \leq r$, for all $x \in [a, b]$.

4. Using Exercises 3 and 2 above, show that while $f : \mathbb{R} \rightarrow \mathbb{R}$ given by $f(x) = \cos x$ does not satisfy the conditions of the Contraction Mapping Theorem, it nevertheless has a unique fixed point.

6.5 Baire Spaces

6.5.1 Theorem. (Baire Category Theorem) Let (X, d) be a complete metric space. If $X_1, X_2, \dots, X_n, \dots$ is a sequence of open dense subsets of X , then the set $\bigcap_{n=1}^{\infty} X_n$ is also dense in X .

Proof. It suffices to show that if U is any open subset of (X, d) , then $U \cap \bigcap_{n=1}^{\infty} X_n \neq \emptyset$.

As X_1 is open and dense in X , the set $U \cap X_1$ is a non-empty open subset of (X, d) . Let U_1 be an open ball of radius at most 1, such that $\overline{U_1} \subset U \cap X_1$.

Inductively define for each positive integer $n > 1$, an open ball U_n of radius at most $1/n$ such that $\overline{U_n} \subset U_{n-1} \cap X_n$.

For each positive integer n , let x_n be any point in U_n . Clearly the sequence $\{x_n\}$ is a Cauchy sequence. As (X, d) is a complete metric space, this sequence converges to a point $x \in X$.

Observe that for every positive integer m , every member of the sequence $\{x_n\}$ is in the closed set $\overline{U_m}$, and so the limit point x is also in the set $\overline{U_m}$.

Then $x \in \overline{U_n}$, for all $n \in \mathbb{N}$. Thus $x \in \bigcap_{n=1}^{\infty} \overline{U_n}$.

But as $U \cap \bigcap_{n=1}^{\infty} X_n \supset \bigcap_{n=1}^{\infty} \overline{U_n} \ni x$, this implies that $U \cap \bigcap_{n=1}^{\infty} X_n \neq \emptyset$, which completes the proof of the theorem. \square

In Exercises 3.2 #5 we introduced the notion of interior of a subset of a topological space.

6.5.2 Definition. Let (X, \mathcal{T}) be any topological space and A any subset of X . The largest open set contained in A is called the **interior** of A and is denoted by $\text{Int}(A)$.

6.5.3 Definition. A subset A of a topological space (X, \mathcal{T}) is said to be **nowhere dense** if the set \overline{A} has empty interior.

These definitions allow us to rephrase Theorem 6.5.1.

6.5.4 Corollary. (Baire Category Theorem) Let (X, d) be a complete metric space. If $X_1, X_2, \dots, X_n, \dots$ is a sequence of subsets of X such that $X = \bigcup_{n=1}^{\infty} X_n$, then for at least one $n \in \mathbb{N}$, the set $\overline{X_n}$ has non-empty interior; that is, X_n is not nowhere dense.

Proof. Exercises 6.5 #2. □

6.5.5 Definition. A topological space (X, d) is said to be a **Baire space** if for every sequence $\{X_n\}$ of open dense subsets of X , the set $\bigcap_{n=1}^{\infty} X_n$ is also dense in X .

6.5.6 Corollary. Every complete metrizable space is a Baire space. □

6.5.7 Remarks. It is important to note that Corollary 6.5.6 is a result in topology, rather than a result in metric space theory.

Note also that there are Baire spaces which are not completely metrizable. (See Exercises 6.5 #4(iv).) □

6.5.8 Example. The topological space \mathbb{Q} is not a Baire space and so is not completely metrizable. To see this, note that the set of rational numbers is countable and let $\mathbb{Q} = \{x_1, x_2, \dots, x_n, \dots\}$. Each of the sets $X_n = \mathbb{Q} \setminus \{x_n\}$ is open and dense in \mathbb{Q} , however $\bigcap_{n=1}^{\infty} X_n = \emptyset$. Thus \mathbb{Q} does not have the Baire space property. □

6.5.9 Remark. You should note that (once we had the Baire Category Theorem) it was harder to prove that \mathbb{Q} is not completely metrizable than the more general result that \mathbb{Q} is not a Baire space.

It is a surprising and important feature not only of topology, but of mathematics generally, that [a more general result is sometimes easier to prove](#). □

6.5.10 Definitions. Let Y be a subset of a topological space (X, \mathcal{T}) . If Y is a union of a countable number of nowhere dense subsets of X , then Y is said to be a set of the **first category** or **meager** in (X, \mathcal{T}) . If Y is not first category, it is said to be a set of the **second category** in (X, \mathcal{T}) .

In Exercises 6.5#

The Baire Category Theorem has many applications in analysis, but these lie outside our study of Topology. However, we shall conclude this section with an important theorem in Banach space theory, namely the Open Mapping Theorem. This theorem is a consequence of the Baire Category Theorem.

6.5.11 Proposition. If Y is a first category subset of a Baire space (X, \mathcal{T}) , then the interior of Y is empty.

Proof. As Y is first category, $Y = \bigcup_{n=1}^{\infty} Y_n$, where each Y_n , $n \in \mathbb{N}$, is nowhere dense.

Let $U \in \mathcal{T}$ be such that $U \subseteq Y$. Then $U \subseteq \bigcup_{n=1}^{\infty} Y_n \subseteq \bigcup_{n=1}^{\infty} \overline{Y_n}$.

So $X \setminus U \supseteq \bigcap_{n=1}^{\infty} (X \setminus \overline{Y_n})$, and each of the sets $X \setminus \overline{Y_n}$ is open and dense in (X, \mathcal{T}) . As (X, \mathcal{T}) is Baire, $\bigcap_{n=1}^{\infty} (X \setminus \overline{Y_n})$ is dense in (X, \mathcal{T}) . So the closed set $X \setminus U$ is dense in (X, \mathcal{T}) . This implies $X \setminus U = X$. Hence $U = \emptyset$. This completes the proof. \square

6.5.12 Corollary. If Y is a first category subset of a Baire space (X, \mathcal{T}) , then $X \setminus Y$ is a second category set.

Proof. If this were not the case, then the Baire space (X, \mathcal{T}) would be a countable union of nowhere dense sets. \square

6.5.13 Remark. As \mathbb{Q} is a first category subset of \mathbb{R} , it follows from Corollary 6.5.12 that the set \mathbb{P} of irrationals is a second category set. \square

6.5.14 Definition. Let S be a subset of a real vector space V . The set S is said to be **convex** if for each $x, y \in S$ and every real number $0 < \lambda < 1$, the point $\lambda x + (1 - \lambda)y$ is in S .

Clearly every subspace of a vector space is convex. Also in any normed vector space, every open ball and every closed ball is convex.

6.5.15 Theorem. (Open Mapping Theorem) Let $(B, \| \cdot \|)$ and $((B_1, \| \cdot \|_1))$ be Banach spaces and $L : B \rightarrow B_1$ a continuous linear (in the vector space sense) mapping of B onto B_1 . Then L is an open mapping.

Proof. By Exercises 6.5#1(iv), it suffices to show that there exists an $N \in \mathbb{N}$ such that $L(B_N(0)) \supset B_s(0)$, for some $s > 0$.

Clearly $B = \bigcup_{n=1}^{\infty} B_n(0)$ and as L is surjective we have $B_1 = L(B) = \bigcup_{n=1}^{\infty} L(B_n(0))$.

As B_1 is a Banach space, by Corollary 6.5.4 of the Baire Category Theorem, there is an $N \in \mathbb{N}$, such that $\overline{L(B_N(0))}$ has non-empty interior.

So there is a $z \in B_1$ and $t > 0$, such that $B_t(z) \subseteq \overline{L(B_N(0))}$.

By Exercises 6.5#3 there is no loss of generality in assuming that $z \in L(B_N(0))$.

But $B_t(z) = B_t(0) + z$, and so

$$B_t(0) \subseteq \overline{L(B_N(0))} - z = \overline{L(B_N(0)) - z} \subseteq \overline{L(B_N(0)) - L(B_N(0))} \subseteq \overline{L(B_{2N}(0))}.$$

which, by the linearity of L , implies that $B_{t/2}(0) \subseteq \overline{L(B_N(0))}$.

We shall show that this implies that $B_{t/4}(0) \subseteq L(B_N(0))$.

Let $w \in B_{t/2}(0)$. Then there is an $x_1 \in B_N(0)$, such that $\|w - L(x_1)\|_1 < \frac{t}{4}$.

Note that by linearity of the mapping L , for each integer $k > 0$

$$B_{t/2}(0) \subseteq \overline{L(B_N(0))} \implies B_{t/(2k)}(0) \subseteq \overline{L(B_{N/k}(0))}.$$

So there is an $x_2 \in B_{N/2}(0)$, such that

$$\|(w - L(x_1)) - L(x_2)\|_1 = \|w - L(x_1) - L(x_2)\|_1 < \frac{t}{8}.$$

Continuing in this way, we obtain by induction a sequence $\{x_m\}$ such that $\|x_m\| < \frac{N}{2^{m-1}}$ and

$$\|w - L(x_1 + x_2 + \cdots + x_m)\|_1 = \|w - L(x_1) - L(x_2) - \cdots - L(x_m)\|_1 < \frac{t}{2^m}.$$

Since B is complete, the series $\sum_{m=1}^{\infty} x_m$ converges to a limit a .

Clearly $\|a\| < 2N$ and by continuity of L , we have $w = L(a) \in L(B_{2N}(0))$.

So $B_{t/2}(0) \subseteq L(B_{2N}(0))$ and thus $B_{t/4}(0) \subseteq L(B_N(0))$ which completes the proof. \square

The following Corollary of the Open Mapping Theorem follows immediately and is a very important special case.

6.5.16 Corollary. A one-to-one continuous linear map of one Banach space onto another Banach space is a homeomorphism. In particular, a one-to-one continuous linear map of a Banach space onto itself is a homeomorphism. □

Exercises 6.5

1. Let (X, \mathcal{T}) and (Y, \mathcal{T}_1) be topological spaces. A mapping $f : (X, \mathcal{T}) \rightarrow (Y, \mathcal{T}_1)$ is said to be an **open mapping** if for every open subset A of (X, \mathcal{T}) , the set $f(A)$ is open in (Y, \mathcal{T}_1) .
 - (i) Show that f is an open mapping if and only if for each $U \in \tau$ and each $x \in U$, the set $f(U)$ is a neighbourhood of $f(x)$.
 - (ii) Let (X, d) and (Y, d_1) be metric spaces and f a mapping of X into Y . Prove that f is an open mapping if and only if for each $n \in \mathbb{N}$ and each $x \in X$, $f(B_{1/n}(x)) \supseteq B_r(f(x))$, for some $r > 0$.
 - (iii) Let $(N, \| \cdot \|)$ and $(N_1, \| \cdot \|_1)$ be normed vector spaces and f a linear mapping of N into N_1 . Prove that f is an open mapping if and only if for each $n \in \mathbb{N}$, $f(B_{1/n}(0)) \supseteq B_r(0)$, for some $r > 0$.
 - (iv) Let $(N, \| \cdot \|)$ and $(N_1, \| \cdot \|_1)$ be normed vector spaces and f a linear mapping of N into N_1 . Prove that f is an open mapping if and only if there exists an $s > 0$ such that $f(B_s(0)) \supseteq B_r(0)$, for some $r > 0$.

2. Using the Baire Category Theorem, prove Corollary 6.5.4.

3. Let A be a subset of a Banach space B . Prove the following are equivalent:
- (i) the set \overline{A} has non-empty interior;
 - (ii) there exists a $z \in \overline{A}$ and $t > 0$ such that $B_t(z) \subseteq \overline{A}$;
 - (ii) there exists a $y \in A$ and $r > 0$ such that $B_r(y) \subseteq \overline{A}$.
4. A point x in a topological space (X, \mathcal{T}) is said to be an **isolated point** if $\{x\} \in \mathcal{T}$. Prove that if (X, \mathcal{T}) is a countable T_1 -space with no isolated points, then it is not a Baire space.
5. (i) Using the version of the Baire Category Theorem in Corollary 6.5.4, prove that \mathbb{P} is not an F_σ -set and \mathbb{Q} is not a G_δ -set in \mathbb{R} .
 [Hint. Suppose that $\mathbb{P} = \bigcup_{n=1}^{\infty} F_n$, where each F_n is a closed subset of \mathbb{R} . Then apply Corollary 6.5.4 to $\mathbb{R} = \bigcup_{n=1}^{\infty} F_n \cup \bigcup_{q \in \mathbb{Q}} \{q\}$.]
- (ii) Let $f : \mathbb{R} \rightarrow \mathbb{R}$ be a function mapping \mathbb{R} into itself. Then f is said to be **continuous at a point** $a \in \mathbb{R}$ if for each open set U containing $f(a)$, there exists an open set V containing a such that $f(V) \subseteq U$. Prove that the set of points in \mathbb{R} at which f is continuous is a G_δ -set.
- (iii) Deduce from (i) and (ii) that there is no function $f : \mathbb{R} \rightarrow \mathbb{R}$ which is continuous precisely at the set of all rational numbers.
6. (i) Let (X, \mathcal{T}) be any topological space, and Y and S dense subsets of X . If S is also open in (X, \mathcal{T}) , prove that $S \cap Y$ is dense in both X and Y .
- (ii) Let \mathcal{T}_1 be the topology induced on Y by \mathcal{T} on X . Let $\{X_n\}$ be a sequence of open dense subsets of Y . Using (i), show that $\{X_n \cap Y\}$ is a sequence of open dense subsets of (Y, \mathcal{T}_1) .
- (iii) Deduce from Definition 6.5.5 and (ii) above, that if (Y, \mathcal{T}_1) is a Baire space, then (X, \mathcal{T}) is also a Baire space. [So [the closure of a Baire space is a Baire space.](#)]
- (iv) Using (iii), show that the subspace (Z, \mathcal{T}_2) of \mathbb{R}^2 given by

$$Z = \{\langle x, y \rangle : x, y \in \mathbb{R}, y > 0\} \cup \{\langle x, 0 \rangle : x \in \mathbb{Q}\},$$

is a Baire space, but is not completely metrizable as the closed subspace $\{\langle x, 0 \rangle : x \in \mathbb{Q}\}$ is homeomorphic to \mathbb{Q} which is not completely metrizable. This also shows that [a closed subspace of a Baire space is not necessarily a Baire space.](#)

7. Let (X, \mathcal{T}) and (Y, \mathcal{T}_1) be topological spaces and $f : (X, \mathcal{T}) \rightarrow (Y, \mathcal{T}_1)$ be a continuous open mapping. If (X, \mathcal{T}) is a Baire space, prove that (X, \mathcal{T}_1) is a Baire space. [So an open continuous image of a Baire space is a Baire space.]
8. Let (Y, \mathcal{T}_1) be an open subspace of the Baire space (X, \mathcal{T}) . Prove that (Y, \mathcal{T}) is a Baire space. [So an open subspace of a Baire space is a Baire space.]
9. Let (X, \mathcal{T}) be a topological space. A function $f : (X, \mathcal{T}) \rightarrow \mathbb{R}$ is said to be **lower semicontinuous** if for each $r \in \mathbb{R}$, the set $f^{-1}((-\infty, r])$ is closed in (X, \mathcal{T}) . A function $f : (X, \mathcal{T}) \rightarrow \mathbb{R}$ is said to be **upper semicontinuous** if for each $r \in \mathbb{R}$, the set $f^{-1}((-\infty, r))$ is open in (X, \mathcal{T}) .
- (i) Prove that f is continuous if and only if it is lower semicontinuous and upper semicontinuous.
- (ii) Let (X, \mathcal{T}) be a Baire space, I an index set and for each $x \in X$, let the set $\{f_i(x) : i \in I\}$ be bounded above, where each mapping $f_i : (X, \mathcal{T}) \rightarrow \mathbb{R}$ is lower semicontinuous. Using the Baire Category Theorem prove that there exists an open subset O of (X, \mathcal{T}) such that the set $\{f_i(x) : x \in O, i \in I\}$ is bounded above.
[Hint. Let $X_n = \bigcap_{i \in I} f_i^{-1}((-\infty, n])$.]
10. Let B be a Banach space where the dimension of the underlying vector space is countable. Using the Baire Category Theorem, prove that the dimension of the underlying vector space is, in fact, finite.
11. Let $(N, \| \cdot \|)$ be a normed vector space and (X, τ) a convex subset of $(N, \| \cdot \|)$ with its induced topology. Show that (X, τ) is path-connected, and hence also connected. Deduce that every open ball in $(N, \| \cdot \|)$ is path-connected as is $(N, \| \cdot \|)$ itself.

6.6 Postscript

Metric space theory is an important topic in its own right. As well, metric spaces hold an important position in the study of topology. Indeed many books on topology begin with metric spaces, and motivate the study of topology via them.

We saw that different metrics on the same set can give rise to the same topology. Such metrics are called equivalent metrics. We were introduced to the study of function spaces, and in particular, $C[0, 1]$. En route we met normed vector spaces, a central topic in functional analysis.

Not all topological spaces arise from metric spaces. We saw this by observing that topologies induced by metrics are Hausdorff.

We saw that the topology of a metric space can be described entirely in terms of its convergent sequences and that continuous functions between metric spaces can also be so described.

Exercises 6.2 #9 introduced the interesting concept of distance between sets in a metric space.

We met the concepts of Cauchy sequence, complete metric space, completely metrizable space, Banach space, Polish space, and Souslin space. Completeness is an important topic in metric space theory because of the central role it plays in applications in analysis. Banach spaces are complete normed vector spaces and are used in many contexts in analysis and have a rich structure theory. We saw that every metric space has a completion, that is can be embedded isometrically in a complete metric space. For example every normed vector space has a completion which is a Banach space.

Contraction mappings were introduced in the concept of fixed points and we saw the proof of the Contraction Mapping Theorem which is also known as the Banach Fixed Point Theorem. This is a very useful theorem in applications for example in the proof of existence of solutions of differential equations.

Another powerful theorem proved in this chapter was the Baire Category Theorem. We introduced the topological notion of a Baire space and saw that every completely metrizable space is a Baire space. En route the notion of first category or meager was introduced. And then we proved the Open Mapping Theorem which says that a continuous linear map from a Banach space onto another Banach space must be an open mapping.

Chapter 7

Compactness

Introduction

The most important topological property is compactness. It plays a key role in many branches of mathematics. It would be fair to say that until you understand compactness you do not understand topology!

So what is compactness? It could be described as the topologists generalization of finiteness. The formal definition says that a topological space is compact if whenever it is a subset of a union of an infinite number of open sets then it is also a subset of a union of a finite number of these open sets. Obviously every finite subset of a topological space is compact. And we quickly see that in a discrete space a set is compact if and only if it is finite. When we move to topological spaces with richer topological structures, such as \mathbb{R} , we discover that infinite sets can be compact. Indeed all closed intervals $[a, b]$ in \mathbb{R} are compact. But intervals of this type are the only ones which are compact.

So we are led to ask: precisely which subsets of \mathbb{R} are compact? The Heine-Borel Theorem will tell us that the compact subsets of \mathbb{R} are precisely the sets which are both closed and bounded.

As we go farther into our study of topology, we shall see that compactness plays a crucial role. This is especially so of applications of topology to analysis.

7.1 Compact Spaces

7.1.1 Definition. Let A be a subset of a topological space (X, \mathcal{T}) . Then A is said to be **compact** if for every set I and every family of open sets, $O_i, i \in I$, such that $A \subseteq \bigcup_{i \in I} O_i$ there exists a finite subfamily $O_{i_1}, O_{i_2}, \dots, O_{i_n}$ such that $A \subseteq O_{i_1} \cup O_{i_2} \cup \dots \cup O_{i_n}$.

7.1.2 Example. If $(X, \mathcal{T}) = \mathbb{R}$ and $A = (0, \infty)$, then A is not compact.

Proof. For each positive integer i , let O_i be the open interval $(0, i)$. Then, clearly, $A \subseteq \bigcup_{i=1}^{\infty} O_i$. But there do *not* exist i_1, i_2, \dots, i_n such that $A \subseteq (0, i_1) \cup (0, i_2) \cup \dots \cup (0, i_n)$. Therefore A is not compact. \square

7.1.3 Example. Let (X, \mathcal{T}) be any topological space and $A = \{x_1, x_2, \dots, x_n\}$ any finite subset of (X, \mathcal{T}) . Then A is compact.

Proof. Let $O_i, i \in I$, be any family of open sets such that $A \subseteq \bigcup_{i \in I} O_i$. Then for each $x_j \in A$, there exists an O_{i_j} , such that $x_j \in O_{i_j}$. Thus $A \subseteq O_{i_1} \cup O_{i_2} \cup \dots \cup O_{i_n}$. So A is compact. \square

7.1.4 Remark. So we see from Example 7.1.3 that every finite set (in a topological space) is compact. Indeed “compactness” can be thought of as a topological generalization of “finiteness”. \square

7.1.5 Example. A subset A of a discrete space (X, \mathcal{T}) is compact if and only if it is finite.

Proof. If A is finite then Example 7.1.3 shows that it is compact.

Conversely, let A be compact. Then the family of singleton sets $O_x = \{x\}, x \in A$ is such that each O_x is open and $A \subseteq \bigcup_{x \in A} O_x$. As A is compact, there exist $O_{x_1}, O_{x_2}, \dots, O_{x_n}$ such that $A \subseteq O_{x_1} \cup O_{x_2} \cup \dots \cup O_{x_n}$; that is, $A \subseteq \{x_1, \dots, x_n\}$. Hence A is a finite set. \square

Of course if all compact sets were finite then the study of “compactness” would not be interesting. However we shall see shortly that, for example, every closed interval $[a, b]$ is compact. Firstly, we introduce a little terminology.

7.1.6 Definitions. Let I be a set and $O_i, i \in I$, a family of open sets in a topological space (X, \mathcal{T}) . Let A be a subset of (X, \mathcal{T}) . Then $O_i, i \in I$, is said to be an **open covering** of A if $A \subseteq \bigcup_{i \in I} O_i$. A finite subfamily, $O_{i_1}, O_{i_2}, \dots, O_{i_n}$, of $O_i, i \in I$ is called a **finite subcovering** (of A) if $A \subseteq O_{i_1} \cup O_{i_2} \cup \dots \cup O_{i_n}$.

So we can rephrase the definition of compactness as follows:

7.1.7 Definitions. A subset A of a topological space (X, \mathcal{T}) is said to be **compact** if every open covering of A has a finite subcovering. If the compact subset A equals X , then (X, \mathcal{T}) is said to be a **compact space**.

7.1.8 Remark. We leave as an exercise the verification of the following statement:

Let A be a subset of (X, \mathcal{T}) and \mathcal{T}_1 the topology induced on A by \mathcal{T} . Then A is a compact subset of (X, \mathcal{T}) if and only if (A, \mathcal{T}_1) is a compact space.

[This statement is not as trivial as it may appear at first sight.] □

7.1.9 Proposition. The closed interval $[0, 1]$ is compact.

Proof. Let $O_i, i \in I$ be any open covering of $[0, 1]$. Then for each $x \in [0, 1]$, there is an O_i such that $x \in O_i$. As O_i is open about x , there exists an interval U_x , open in $[0, 1]$ such that $x \in U_x \subseteq O_i$.

Now define a subset S of $[0, 1]$ as follows:

$$S = \{z : [0, z] \text{ can be covered by a finite number of the sets } U_x\}.$$

[So $z \in S \Rightarrow [0, z] \subseteq U_{x_1} \cup U_{x_2} \cup \dots \cup U_{x_n}$, for some x_1, x_2, \dots, x_n .]

Now let $x \in S$ and $y \in U_x$. Then as U_x is an interval containing x and y , $[x, y] \subseteq U_x$. (Here we are assuming, without loss of generality that $x \leq y$.) So

$$[0, y] \subseteq U_{x_1} \cup U_{x_2} \cup \dots \cup U_{x_n} \cup U_x$$

and hence $y \in S$.

So for each $x \in [0, 1]$, $U_x \cap S = U_x$ or \emptyset .

This implies that

$$S = \bigcup_{x \in S} U_x$$

and

$$[0, 1] \setminus S = \bigcup_{x \notin S} U_x.$$

Thus we have that S is open in $[0, 1]$ and S is closed in $[0, 1]$. But $[0, 1]$ is connected. Therefore $S = [0, 1]$ or \emptyset .

However $0 \in S$ and so $S = [0, 1]$; that is, $[0, 1]$ can be covered by a finite number of U_x . So $[0, 1] \subseteq U_{x_1} \cup U_{x_2} \cup \dots \cup U_{x_m}$. But each U_{x_i} is contained in an $O_i, i \in I$. Hence $[0, 1] \subseteq O_{i_1} \cup O_{i_2} \cup \dots \cup O_{i_m}$ and we have shown that $[0, 1]$ is compact. \square

Exercises 7.1

1. Let (X, \mathcal{T}) be an indiscrete space. Prove that every subset of X is compact.
2. Let \mathcal{T} be the finite-closed topology on any set X . Prove that every subset of (X, \mathcal{T}) is compact.
3. Prove that each of the following spaces is *not* compact.
 - (i) $(0, 1)$;
 - (ii) $[0, 1)$;
 - (iii) \mathbb{Q} ;
 - (iv) \mathbb{P} ;
 - (v) \mathbb{R}^2 ;
 - (vi) the open disc $D = \{(x, y) : x^2 + y^2 < 1\}$ considered as a subspace of \mathbb{R}^2 ;
 - (vii) the Sorgenfrey line;
 - (viii) $C[0, 1]$ with the topology induced by the metric d of Example 6.1.5;
 - (ix) $\ell_1, \ell_2, \ell_\infty, c_0$ with the topologies induced respectively by the metrics d_1, d_2, d_∞ , and d_0 of Exercises 6.1 #7.
4. Is $[0, 1]$ a compact subset of the Sorgenfrey line?
5. Is $[0, 1] \cap \mathbb{Q}$ a compact subset of \mathbb{Q} ?
6. Verify that $S = \{0\} \cup \bigcup_{n=1}^{\infty} \{\frac{1}{n}\}$ is a compact subset of \mathbb{R} while $\bigcup_{n=1}^{\infty} \{\frac{1}{n}\}$ is not.

7.2 The Heine-Borel Theorem

The next proposition says that “a continuous image of a compact space is compact”.

7.2.1 Proposition. Let $f : (X, \mathcal{T}) \rightarrow (Y, \mathcal{T}_1)$ be a continuous surjective map. If (X, \mathcal{T}) is compact, then (Y, \mathcal{T}_1) is compact.

Proof. Let $O_i, i \in I$, be any open covering of Y ; that is $Y \subseteq \bigcup_{i \in I} O_i$.

Then $f^{-1}(Y) \subseteq f^{-1}(\bigcup_{i \in I} O_i)$; that is, $X \subseteq \bigcup_{i \in I} f^{-1}(O_i)$.

So $f^{-1}(O_i), i \in I$, is an open covering of X .

As X is compact, there exist i_1, i_2, \dots, i_n in I such that

$$X \subseteq f^{-1}(O_{i_1}) \cup f^{-1}(O_{i_2}) \cup \dots \cup f^{-1}(O_{i_n}).$$

$$\begin{aligned} \text{So } Y &= f(X) \\ &\subseteq f(f^{-1}(O_{i_1}) \cup f^{-1}(O_{i_2}) \cup \dots \cup f^{-1}(O_{i_n})) \\ &= f(f^{-1}(O_{i_1})) \cup f(f^{-1}(O_{i_2})) \cup \dots \cup f(f^{-1}(O_{i_n})) \\ &= O_{i_1} \cup O_{i_2} \cup \dots \cup O_{i_n}, \quad \text{since } f \text{ is surjective.} \end{aligned}$$

So we have $Y \subseteq O_{i_1} \cup O_{i_2} \cup \dots \cup O_{i_n}$; that is, Y is covered by a finite number of O_i .

Hence Y is compact. □

7.2.2 Corollary. Let (X, \mathcal{T}) and (Y, \mathcal{T}_1) be homeomorphic topological spaces. If (X, \mathcal{T}) is compact, then (Y, \mathcal{T}_1) is compact. □

7.2.3 Corollary. For a and b in \mathbb{R} with $a < b$, $[a, b]$ is compact while (a, b) is not compact.

Proof. The space $[a, b]$ is homeomorphic to the compact space $[0, 1]$ and so, by Proposition 7.2.1, is compact.

The space (a, b) is homeomorphic to $(0, \infty)$. If (a, b) were compact, then $(0, \infty)$ would be compact, but we saw in Example 7.1.2 that $(0, \infty)$ is not compact. Hence (a, b) is not compact. □

7.2.4 Proposition. Every closed subset of a compact space is compact.

Proof. Let A be a closed subset of a compact space (X, \mathcal{T}) . Let $U_i \in \mathcal{T}$, $i \in I$, be any open covering of A . Then

$$X \subseteq \left(\bigcup_{i \in I} U_i \right) \cup (X \setminus A);$$

that is, U_i , $i \in I$, together with the open set $X \setminus A$ is an open covering of X . Therefore there exists a finite subcovering $U_{i_1}, U_{i_2}, \dots, U_{i_k}, X \setminus A$. [If $X \setminus A$ is not in the finite subcovering then we can include it and still have a finite subcovering of X .]

So

$$X \subseteq U_{i_1} \cup U_{i_2} \cup \dots \cup U_{i_k} \cup (X \setminus A).$$

Therefore,

$$A \subseteq U_{i_1} \cup U_{i_2} \cup \dots \cup U_{i_k} \cup (X \setminus A)$$

which clearly implies

$$A \subseteq U_{i_1} \cup U_{i_2} \cup \dots \cup U_{i_k}$$

since $A \cap (X \setminus A) = \emptyset$. Hence A has a finite subcovering and so is compact. \square

7.2.5 Proposition. A compact subset of a Hausdorff topological space is closed.

Proof. Let A be a compact subset of the Hausdorff space (X, \mathcal{T}) . We shall show that A contains all its limit points and hence is closed. Let $p \in X \setminus A$. Then for each $a \in A$, there exist open sets U_a and V_a such that $a \in U_a$, $p \in V_a$ and $U_a \cap V_a = \emptyset$.

Then $A \subseteq \bigcup_{a \in A} U_a$. As A is compact, there exist a_1, a_2, \dots, a_n in A such that

$$A \subseteq U_{a_1} \cup U_{a_2} \cup \dots \cup U_{a_n}.$$

Put $U = U_{a_1} \cup U_{a_2} \cup \dots \cup U_{a_n}$ and $V = V_{a_1} \cap V_{a_2} \cap \dots \cap V_{a_n}$. Then $p \in V$ and $V \cap U = \emptyset$ implies $V \cap A = \emptyset$ which in turn implies $V \cap A = \emptyset$. So p is not a limit point of A , and V is an open set containing p which does not intersect A .

Hence A contains all of its limit points and is therefore closed. \square

7.2.6 Corollary. A compact subset of a metrizable space is closed. \square

7.2.7 Example. For a and b in \mathbb{R} with $a < b$, the intervals $[a, b)$ and $(a, b]$ are not compact as they are not closed subsets of the metrizable space \mathbb{R} . \square

7.2.8 Proposition. A compact subset of \mathbb{R} is bounded.

Proof. Let $A \subseteq \mathbb{R}$ be unbounded. Then $A \subseteq \bigcup_{n=1}^{\infty} (-n, n)$, but $\{(-n, n) : n = 1, 2, 3, \dots\}$ does not have any finite subcovering of A as A is unbounded. Therefore A is not compact. Hence all compact subsets of \mathbb{R} are bounded. \square

7.2.9 Theorem. (Heine-Borel Theorem) Every closed bounded subset of \mathbb{R} is compact.

Proof. If A is a closed bounded subset of \mathbb{R} , then $A \subseteq [a, b]$, for some a and b in \mathbb{R} . As $[a, b]$ is compact and A is a closed subset, A is compact. \square

The Heine-Borel Theorem is an important result. The proof above is short only because we extracted and proved Proposition 7.1.9 first.

7.2.10 Proposition. (Converse of Heine-Borel Theorem) Every compact subset of \mathbb{R} is closed and bounded.

Proof. This follows immediately from Propositions 7.2.8 and 7.2.5. \square

7.2.11 Definition. A subset A of a metric space (X, d) is said to be **bounded** if there exists a real number r such that $d(a_1, a_2) \leq r$, for all a_1 and a_2 in A .

7.2.12 Proposition. Let A be a compact subset of a metric space (X, d) . Then A is closed and bounded.

Proof. By Corollary 7.2.6, A is a closed set. Now fix $x_0 \in X$ and define the mapping $f : (A, \mathcal{T}) \rightarrow \mathbb{R}$ by

$$f(a) = d(a, x_0), \text{ for every } a \in A,$$

where \mathcal{T} is the induced topology on A . Then f is continuous and so, by Proposition 7.2.1, $f(A)$ is compact. Thus, by Proposition 7.2.10, $f(A)$ is bounded; that is, there exists a real number M such that

$$f(a) \leq M, \text{ for all } a \in A.$$

Thus $d(a, x_0) \leq M$, for all $a \in A$. Putting $r = 2M$, we see by the triangle inequality that $d(a_1, a_2) \leq r$, for all a_1 and a_2 in A . \square

Recalling that \mathbb{R}^n denotes the n -dimensional euclidean space with the topology induced by the euclidean metric, it is possible to generalize the Heine-Borel Theorem and its converse from \mathbb{R} to \mathbb{R}^n , $n > 1$. We state the result here but delay its proof until the next chapter.

7.2.13 Theorem. (Generalized Heine-Borel Theorem) A subset of \mathbb{R}^n , $n \geq 1$, is compact if and only if it is closed and bounded.

Warning. Although Theorem 7.2.13 says that every closed bounded subset of \mathbb{R}^n is compact, closed bounded subsets of other metric spaces need not be compact. (See Exercises 7.2 #9.)

7.2.14 Proposition. Let (X, \mathcal{T}) be a compact space and f a continuous mapping from (X, \mathcal{T}) into \mathbb{R} . Then the set $f(X)$ has a greatest element and a least element.

Proof. As f is continuous, $f(X)$ is compact. Therefore $f(X)$ is a closed bounded subset of \mathbb{R} . As $f(X)$ is bounded, it has a supremum. Since $f(X)$ is closed, Lemma 3.3.2 implies that the supremum is in $f(X)$. Thus $f(X)$ has a greatest element – namely its supremum. Similarly it can be shown that $f(X)$ has a least element. \square

7.2.15 Proposition. Let a and b be in \mathbb{R} and f a continuous function from $[a, b]$ into \mathbb{R} . Then $f([a, b]) = [c, d]$, for some c and d in \mathbb{R} .

Proof. As $[a, b]$ is connected, $f([a, b])$ is a connected subset of \mathbb{R} and hence is an interval. As $[a, b]$ is compact, $f([a, b])$ is compact. So $f([a, b])$ is a closed bounded interval. Hence

$$f([a, b]) = [c, d]$$

for some c and d in \mathbb{R} . □

Exercises 7.2

1. Which of the following subsets of \mathbb{R} are compact? (Justify your answers.)
 - (i) \mathbb{Z} ;
 - (ii) $\{\frac{\sqrt{2}}{n} : n = 1, 2, 3, \dots\}$;
 - (iii) $\{x : x = \cos y, y \in [0, 1]\}$;
 - (iv) $\{x : x = \tan y, y \in [0, \pi/2)\}$.

2. Which of the following subsets of \mathbb{R}^2 are compact? (Justify your answers.)
 - (i) $\{(x, y) : x^2 + y^2 = 4\}$
 - (ii) $\{(x, y) : x \geq y + 1\}$
 - (iii) $\{(x, y) : 0 \leq x \leq 2, 0 \leq y \leq 4\}$
 - (iv) $\{(x, y) : 0 < x < 2, 0 \leq y \leq 4\}$

3. Let (X, \mathcal{T}) be a compact space. If $\{F_i : i \in I\}$ is a family of closed subsets of X such that $\bigcap_{i \in I} F_i = \emptyset$, prove that there is a finite subfamily

$$F_{i_1}, F_{i_2}, \dots, F_{i_m} \text{ such that } F_{i_1} \cap F_{i_2} \cap \dots \cap F_{i_m} = \emptyset.$$

4. Corollary 4.3.7 says that for real numbers a, b, c and d with $a < b$ and $c < d$,

(i) $(a, b) \not\cong [c, d]$

(ii) $[a, b] \not\cong [c, d]$.

Prove each of these using a compactness argument (rather than a connectedness argument as was done in Corollary 4.3.7).

5. Let (X, \mathcal{T}) and (Y, \mathcal{T}_1) be topological spaces. A mapping $f : (X, \mathcal{T}) \rightarrow (Y, \mathcal{T}_1)$ is said to be a **closed mapping** if for every closed subset A of (X, \mathcal{T}) , $f(A)$ is closed in (Y, \mathcal{T}_1) . A function $f : (X, \mathcal{T}) \rightarrow (Y, \mathcal{T}_1)$ is said to be an **open mapping** if for every open subset A of (X, \mathcal{T}) , $f(A)$ is open in (Y, \mathcal{T}_1) .

(a) Find examples of mappings f which are

(i) open but not closed

(ii) closed but not open

(iii) open but not continuous

(iv) closed but not continuous

(v) continuous but not open

(vi) continuous but not closed.

(b) If (X, \mathcal{T}) and (Y, \mathcal{T}_1) are compact Hausdorff spaces and $f : (X, \mathcal{T}) \rightarrow (Y, \mathcal{T}_1)$ is a continuous mapping, prove that f is a closed mapping.

6. Let $f : (X, \mathcal{T}) \rightarrow (Y, \mathcal{T}_1)$ be a continuous bijection. If (X, \mathcal{T}) is compact and (Y, \mathcal{T}_1) is Hausdorff, prove that f is a homeomorphism.

7. Let $\{C_j : j \in J\}$ be a family of closed compact subsets of a topological space (X, \mathcal{T}) . Prove that $\bigcap_{j \in J} C_j$ is compact.

8. Let n be a positive integer, d the euclidean metric on \mathbb{R}^n , and X a subset of \mathbb{R}^n . Prove that X is bounded in (\mathbb{R}^n, d) if and only if there exists a positive real number M such that for all $\langle x_1, x_2, \dots, x_n \rangle \in X$, $-M \leq x_i \leq M$, $i = 1, 2, \dots, n$.

9. Let $(C[0, 1], d^*)$ be the metric space defined in Example 6.1.6. Let $B = \{f : f \in C[0, 1] \text{ and } d^*(f, 0) \leq 1\}$ where 0 denotes the constant function from $[0, 1]$ into \mathbb{R} which maps every element to zero. (The set B is called the **closed unit ball**.)
- (i) Verify that B is closed and bounded in $(C[0, 1], d^*)$.
- (ii) Prove that B is not compact. [Hint: Let $\{B_i : i \in I\}$ be the family of all open balls of radius $\frac{1}{2}$ in $(C[0, 1], d^*)$. Then $\{B_i : i \in I\}$ is an open covering of B . Suppose there exists a finite subcovering B_1, B_2, \dots, B_N . Consider the $(N + 1)$ functions $f_\alpha : [0, 1] \rightarrow \mathbb{R}$ given by $f_\alpha(x) = \sin(2^{N-\alpha} \cdot \pi \cdot x)$, $\alpha = 1, 2, \dots, N + 1$.
- (a) Verify that each $f_\alpha \in B$.
- (b) Observing that $f_{N+1}(1) = 1$ and $f_m(1) = 0$, for all $m \leq N$, deduce that if $f_{N+1} \in B_1$ then $f_m \notin B_1$, $m = 1, \dots, N$.
- (c) Observing that $f_N(\frac{1}{2}) = 1$ and $f_m(\frac{1}{2}) = 0$, for all $m \leq N - 1$, deduce that if $f_N \in B_2$ then $f_m \notin B_2$, $m = 1, \dots, N - 1$.
- (d) Continuing this process, show that f_1, f_2, \dots, f_{N+1} lie in distinct B_i – a contradiction.]
10. Prove that every compact Hausdorff space is a normal space.
- 11.* Let A and B be disjoint compact subsets of a Hausdorff space (X, \mathcal{T}) . Prove that there exist disjoint open sets G and H such that $A \subseteq G$ and $B \subseteq H$.
12. Let (X, \mathcal{T}) be an infinite topological space with the property that every subspace is compact. Prove that (X, \mathcal{T}) is not a Hausdorff space.
13. Prove that every uncountable topological space which is not compact has an uncountable number of subsets which are compact and an uncountable number which are not compact.
14. If (X, \mathcal{T}) is a Hausdorff space such that every proper closed subspace is compact, prove that (X, \mathcal{T}) is compact.

7.3 Postscript

Compactness plays a key role in applications of topology to all branches of analysis. As noted in Remark 7.1.4 it can be thought as a topological generalization of finiteness.

The Generalized Heine-Borel Theorem characterizes the compact subsets of \mathbb{R}^n as those which are closed and bounded.

Compactness is a topological property. Indeed any continuous image of a compact space is compact.

Closed subsets of compact spaces are compact and compact subspaces of Hausdorff spaces are closed.

Exercises 7.2 # 5 introduces the notions of open mappings and closed mappings. Exercises 7.2 #10 notes that a compact Hausdorff space is a normal space (indeed a T_4 -space). That the closed unit ball in each \mathbb{R}^n is compact contrasts with Exercises 7.2 #9. This exercise points out that the closed unit ball in the metric space $(C[0, 1], d^*)$ is not compact. Though we shall not prove it here, it can be shown that a normed vector space is finite-dimensional if and only if its closed unit ball is compact.

Warning. It is unfortunate that “compact” is defined in different ways in different books and some of these are not equivalent to the definition presented here. Firstly some books include Hausdorff in the definition of compact. Some books, particularly older ones, use “compact” to mean a weaker property than ours—what is often called sequentially compact. Finally the term “bikompakt” is often used to mean compact or compact Hausdorff in our sense.

Chapter 8

Finite Products

Introduction

There are three important ways of creating new topological spaces from old ones. They are by forming “subspaces”, “quotient spaces”, and “product spaces”. The next three chapters are devoted to the study of product spaces. In this chapter we investigate finite products and prove Tychonoff’s Theorem. This seemingly innocuous theorem says that any product of compact spaces is compact. So we are led to ask: precisely which subsets of \mathbb{R} are compact? The Heine-Borel Theorem will tell us that the compact subsets of \mathbb{R} are precisely the sets which are both closed and bounded.

As we go farther into our study of topology, we shall see that compactness plays a crucial role. This is especially so of applications of topology to analysis.

8.1 The Product Topology

If X_1, X_2, \dots, X_n are sets then the **product** $X_1 \times X_2 \times \dots \times X_n$ is the set consisting of all the ordered n -tuples $\langle x_1, x_2, \dots, x_n \rangle$, where $x_i \in X_i$, $i = 1, \dots, n$.

The problem we now discuss is:

Given topological spaces $(X_1, \mathcal{T}_1), (X_2, \mathcal{T}_2), \dots, (X_n, \mathcal{T}_n)$ how do we define a reasonable topology \mathcal{T} on the product set $X_1 \times X_2 \times \dots \times X_n$?

An obvious (but incorrect!) candidate for \mathcal{T} is the set of all sets $O_1 \times O_2 \times \dots \times O_n$, where $O_i \in \mathcal{T}_i$, $i = 1, \dots, n$. Unfortunately this is not a topology.

For example, if $n = 2$ and $(X, \mathcal{T}_1) = (X, \mathcal{T}_2) = \mathbb{R}$ then \mathcal{T} would contain the rectangles $(0, 1) \times (0, 1)$ and $(2, 3) \times (2, 3)$ but not the set $[(0, 1) \times (0, 1)] \cup [(2, 3) \times (2, 3)]$, since this is not $O_1 \times O_2$ for any choice of O_1 and O_2 .

[If it were $O_1 \times O_2$ for some O_1 and O_2 , then $\frac{1}{2} \in (0, 1) \subseteq O_1$ and $2\frac{1}{2} \in (2, 3) \subseteq O_2$ and so the ordered pair $\langle \frac{1}{2}, 2\frac{1}{2} \rangle \in O_1 \times O_2$ but $\langle \frac{1}{2}, 2\frac{1}{2} \rangle \notin [(0, 1) \times (0, 1)] \cup [(2, 3) \times (2, 3)]$.] Thus \mathcal{T} is not closed under unions and so is not a topology.

However we have already seen how to put a topology (the euclidean topology) on $\mathbb{R}^2 = \mathbb{R} \times \mathbb{R}$. This was done in Example 2.2.9. Indeed this example suggests how to define the product topology in general.

8.1.1 Definitions. Let $(X_1, \mathcal{T}_1), (X_2, \mathcal{T}_2), \dots, (X_n, \mathcal{T}_n)$ be topological spaces. Then the **product topology** \mathcal{T} on the set $X_1 \times X_2 \times \dots \times X_n$ is the topology having the family $\{O_1 \times O_2 \times \dots \times O_n, O_i \in \mathcal{T}_i, i = 1, \dots, n\}$ as a basis. The set $X_1 \times X_2 \times \dots \times X_n$ with the topology \mathcal{T} is said to be the **product of the spaces** $(X_1, \mathcal{T}_1), (X_2, \mathcal{T}_2), \dots, (X_n, \mathcal{T}_n)$ and is denoted by $(X_1 \times X_2 \times \dots \times X_n, \mathcal{T})$ or $(X_1, \mathcal{T}_1) \times (X_2, \mathcal{T}_2) \times \dots \times (X_n, \mathcal{T}_n)$.

Of course it must be verified that the family $\{O_1 \times O_2 \times \dots \times O_n : O_i \in \mathcal{T}_i, i = 1, \dots, n\}$ is a basis for a topology; that is, it satisfies the conditions of Proposition 2.2.8. (This is left as an exercise for you.)

8.1.2 Proposition. Let $\mathcal{B}_1, \mathcal{B}_2, \dots, \mathcal{B}_n$ be bases for topological spaces $(X_1, \mathcal{T}_1), (X_2, \mathcal{T}_2), \dots, (X_n, \mathcal{T}_n)$, respectively. Then the family $\{O_1 \times O_2 \times \dots \times O_n : O_i \in \mathcal{B}_i, i = 1, \dots, n\}$ is a basis for the product topology on $X_1 \times X_2 \times \dots \times X_n$.

The proof of Proposition 8.1.2 is straightforward and is also left as an exercise for you.

8.1.3 Observations (i) We now see that the euclidean topology on \mathbb{R}^n , $n \geq 2$, is just the product topology on the set $\mathbb{R} \times \mathbb{R} \times \dots \times \mathbb{R} = \mathbb{R}^n$. (See Example 2.2.9 and Remark 2.2.10.)

(ii) It is clear from Definitions 8.1.1 that any product of open sets is an open set or more precisely: if O_1, O_2, \dots, O_n are open subsets of topological spaces $(X_1, \mathcal{T}_1), (X_2, \mathcal{T}_2), \dots, (X_n, \mathcal{T}_n)$, respectively, then $O_1 \times O_2 \times \dots \times O_n$ is an open subset of $(X_1, \mathcal{T}_1) \times (X_2, \mathcal{T}_2) \times \dots \times (X_n, \mathcal{T}_n)$. The next proposition says that any product of closed sets is a closed set.

8.1.4 Proposition. Let C_1, C_2, \dots, C_n be closed subsets of the topological spaces $(X_1, \mathcal{T}_1), (X_2, \mathcal{T}_2), \dots, (X_n, \mathcal{T}_n)$, respectively. Then $C_1 \times C_2 \times \dots \times C_n$ is a closed subset of the product space $(X_1 \times X_2 \times \dots \times X_n, \mathcal{T})$.

Proof. Observe that

$$\begin{aligned} & (X_1 \times X_2 \times \dots \times X_n) \setminus (C_1 \times C_2 \times \dots \times C_n) \\ = & [(X_1 \setminus C_1) \times X_2 \times \dots \times X_n] \cup [X_1 \times (X_2 \setminus C_2) \times X_3 \times \dots \times X_n] \cup \\ & \dots \cup [X_1 \times X_2 \times \dots \times X_{n-1} \times (X_n \setminus C_n)] \end{aligned}$$

which is a union of open sets (as a product of open sets is open) and so is an open set in $(X_1, \mathcal{T}_1) \times (X_2, \mathcal{T}_2) \times \dots \times (X_n, \mathcal{T}_n)$. Therefore its complement, $C_1 \times C_2 \times \dots \times C_n$, is a closed set, as required. \square

Exercises 8.1

1. Prove Proposition 8.1.2.
2. If $(X_1, \mathcal{T}_1), (X_2, \mathcal{T}_2), \dots, (X_n, \mathcal{T}_n)$ are discrete spaces, prove that the product space $(X_1, \mathcal{T}_1) \times (X_2, \mathcal{T}_2) \times \cdots \times (X_n, \mathcal{T}_n)$ is also a discrete space.
3. Let X_1 and X_2 be infinite sets and \mathcal{T}_1 and \mathcal{T}_2 the finite-closed topology on X_1 and X_2 , respectively. Show that the product topology, \mathcal{T} , on $X_1 \times X_2$ is not the finite-closed topology.
4. Prove that the product of any finite number of indiscrete spaces is an indiscrete space.
5. Prove that the product of any finite number of Hausdorff spaces is Hausdorff.
6. Let (X, \mathcal{T}) be a topological space and $D = \{(x, x) : x \in X\}$ the diagonal in the product space $(X, \mathcal{T}) \times (X, \mathcal{T}) = (X \times X, \mathcal{T}_1)$. Prove that (X, \mathcal{T}) is a Hausdorff space if and only if D is closed in $(X \times X, \mathcal{T}_1)$.
7. Let $(X_1, \mathcal{T}_1), (X_2, \mathcal{T}_2)$ and (X_3, \mathcal{T}_3) be topological spaces. Prove that
$$[(X_1, \mathcal{T}_1) \times (X_2, \mathcal{T}_2)] \times (X_3, \mathcal{T}_3) \cong (X_1, \mathcal{T}_1) \times (X_2, \mathcal{T}_2) \times (X_3, \mathcal{T}_3).$$
8. (i) Let (X_1, \mathcal{T}_1) and (X_2, \mathcal{T}_2) be topological spaces. Prove that
$$(X_1, \mathcal{T}_1) \times (X_2, \mathcal{T}_2) \cong (X_2, \mathcal{T}_2) \times (X_1, \mathcal{T}_1).$$
(ii) Generalize the above result to products of any finite number of topological spaces.

9. Let C_1, C_2, \dots, C_n be subsets of the topological spaces $(X_1, \mathcal{T}_1), (X_2, \mathcal{T}_2), \dots, (X_n, \mathcal{T}_n)$, respectively, so that $C_1 \times C_2 \times \dots \times C_n$ is a subset of $(X_1, \mathcal{T}_1) \times (X_2, \mathcal{T}_2) \times \dots \times (X_n, \mathcal{T}_n)$. Prove each of the following statements.

(i) $(C_1 \times C_2 \times \dots \times C_n)' \supseteq C_1' \times C_2' \times \dots \times C_n'$;

(ii) $\overline{C_1 \times C_2 \times \dots \times C_n} = \overline{C_1} \times \overline{C_2} \times \dots \times \overline{C_n}$;

- (iii) if C_1, C_2, \dots, C_n are dense in $(X_1, \mathcal{T}_1), (X_2, \mathcal{T}_2), \dots, (X_n, \mathcal{T}_n)$, respectively, then $C_1 \times C_2 \times \dots \times C_n$ is dense in the product space $(X_1, \mathcal{T}_1) \times (X_2, \mathcal{T}_2) \times \dots \times (X_n, \mathcal{T}_n)$;

- (iv) if $(X_1, \mathcal{T}_1), (X_2, \mathcal{T}_2), \dots, (X_n, \mathcal{T}_n)$ are separable spaces, then $(X_1, \mathcal{T}_1) \times (X_2, \mathcal{T}_2) \times \dots \times (X_n, \mathcal{T}_n)$ is a separable space;

- (v) for each $n \geq 1$, \mathbb{R}^n is a separable space.

10. Show that the product of a finite number of T_1 -spaces is a T_1 -space.

11. If $(X_1, \mathcal{T}_1), \dots, (X_n, \mathcal{T}_n)$ satisfy the second axiom of countability, show that $(X_1, \mathcal{T}_1) \times (X_2, \mathcal{T}_2) \times \dots \times (X_n, \mathcal{T}_n)$ satisfies the second axiom of countability also.

12. Let $(\mathbb{R}, \mathcal{T}_1)$ be the Sorgenfrey line, defined in Exercises 3.2 #11, and $(\mathbb{R}^2, \mathcal{T}_2)$ be the product space $(\mathbb{R}, \mathcal{T}_1) \times (\mathbb{R}, \mathcal{T}_1)$. Prove the following statements.

- (i) $\{\langle x, y \rangle : a \leq x < b, c \leq y < d, a, b, c, d \in \mathbb{R}\}$ is a basis for the topology \mathcal{T}_2 .

- (ii) $(\mathbb{R}^2, \mathcal{T}_2)$ is a regular separable totally disconnected Hausdorff space.

- (iii) Let $L = \{\langle x, y \rangle : x, y \in \mathbb{R} \text{ and } x + y = 0\}$. Then the line L is closed in the euclidean topology on the plane and hence also in $(\mathbb{R}^2, \mathcal{T}_2)$.

- (iv) If \mathcal{T}_3 is the subspace topology induced on the line L by \mathcal{T}_2 , then \mathcal{T}_3 is the discrete topology, and hence (L, \mathcal{T}_3) is not a separable space. [As (L, \mathcal{T}_3) is a closed subspace of the separable space $(\mathbb{R}^2, \mathcal{T}_2)$, we now know that **a closed subspace of a separable space is not necessarily separable.**]

[Hint: show that $L \cap \{\langle x, y \rangle : a \leq x < a + 1, -a \leq y < -a + 1, a \in \mathbb{R}\}$ is a singleton set.]

8.2 Projections onto Factors of a Product

Before proceeding to our next result we need a couple of definitions.

8.2.1 Definitions. Let \mathcal{T}_1 and \mathcal{T}_2 be topologies on a set X . Then \mathcal{T}_1 is said to be a **finer topology** than \mathcal{T}_2 (and \mathcal{T}_2 is said to be a **coarser topology** than \mathcal{T}_1) if $\mathcal{T}_1 \supseteq \mathcal{T}_2$.

8.2.2 Example. The discrete topology on a set X is finer than any other topology on X . The indiscrete topology on X is coarser than any other topology on X . [See also Exercises 5.1 #10.] \square

8.2.3 Definitions. Let (X, \mathcal{T}) and (Y, \mathcal{T}_1) be topological spaces and f a mapping from X into Y . Then f is said to be an **open mapping** if for every $A \in \mathcal{T}$, $f(A) \in \mathcal{T}_1$. The mapping f is said to be a **closed mapping** if for every closed set B in (X, \mathcal{T}) , $f(B)$ is closed in (Y, \mathcal{T}_1) .

8.2.4 Remark. In Exercises 7.2 #5, you were asked to show that none of the conditions “continuous mapping”, “open mapping”, “closed mapping”, implies either of the other two conditions. Indeed no two of these conditions taken together implies the third. (Find examples to verify this.) \square

8.2.5 Proposition. Let $(X, \mathcal{T}_1), (X_2, \mathcal{T}_2), \dots, (X_n, \mathcal{T}_n)$ be topological spaces and $(X_1 \times X_2 \times \cdots \times X_n, \mathcal{T})$ their product space.

For each $i \in \{1, \dots, n\}$, let $p_i : X_1 \times X_2 \times \cdots \times X_n \rightarrow X_i$ be the projection mapping; that is, $p_i(\langle x_1, x_2, \dots, x_i, \dots, x_n \rangle) = x_i$, for each $\langle x_1, x_2, \dots, x_i, \dots, x_n \rangle \in X_1 \times X_2 \times \cdots \times X_n$. Then

- (i) each p_i is a continuous surjective open mapping, and
- (ii) \mathcal{T} is the coarsest topology on the set $X_1 \times X_2 \times \cdots \times X_n$ such that each p_i is continuous.

Proof. Clearly each p_i is surjective. To see that each p_i is continuous, let U be any open set in (X_i, \mathcal{T}_i) . Then

$$p_i^{-1}(U) = X_1 \times X_2 \times \cdots \times X_{i-1} \times U \times X_{i+1} \times \cdots \times X_n$$

which is a product of open sets and so is open in $(X_1 \times X_2 \times \cdots \times X_n, \mathcal{T})$. Hence each p_i is continuous.

To show that p_i is an open mapping it suffices to verify that for each basic open set $U_1 \times U_2 \times \cdots \times U_n$, where U_j is open in (X_j, \mathcal{T}_j) , for $j = 1, \dots, n$, the set $p_i(U_1 \times U_2 \times \cdots \times U_n)$ is open in (X_i, \mathcal{T}_i) . But $p_i(U_1 \times U_2 \times \cdots \times U_n) = U_i$ which is, of course, open in (X_i, \mathcal{T}_i) . So each p_i is an open mapping. We have now verified part (i) of the proposition.

Now let \mathcal{T}' be any topology on the set $X_1 \times X_2 \times \cdots \times X_n$ such that each projection mapping $p_i : (X_1 \times X_2 \times \cdots \times X_n, \mathcal{T}') \rightarrow (X_i, \mathcal{T}_i)$ is continuous. We have to show that $\mathcal{T}' \supseteq \mathcal{T}$.

Recalling the definition of the basis for the topology \mathcal{T} (given in Definition 8.1.1) it suffices to show that if O_1, O_2, \dots, O_n are open sets in $(X_1, \mathcal{T}_1), (X_2, \mathcal{T}_2), \dots, (X_n, \mathcal{T}_n)$ respectively, then $O_1 \times O_2 \times \cdots \times O_n \in \mathcal{T}'$. To show this, observe that as p_i is continuous, $p_i^{-1}(O_i) \in \mathcal{T}'$, for each $i = 1, \dots, n$. Now

$$p_i^{-1}(O_i) = X_1 \times X_2 \times \cdots \times X_{i-1} \times O_i \times X_{i+1} \times \cdots \times X_n,$$

so that

$$\bigcap_{i=1}^n p_i^{-1}(O_i) = O_1 \times O_2 \times \cdots \times O_n.$$

Then $p_i^{-1}(O_i) \in \mathcal{T}'$ for $i = 1, \dots, n$, implies $\bigcap_{i=1}^n p_i^{-1}(O_i) \in \mathcal{T}'$; that is, $O_1 \times O_2 \times \cdots \times O_n \in \mathcal{T}'$, as required. \square

8.2.6 Remark. Proposition 8.2.5 (ii) gives us another way of defining the product topology. Given topological spaces $(X_1, \mathcal{T}_1), (X_2, \mathcal{T}_2), \dots, (X_n, \mathcal{T}_n)$ the product topology can be defined as the coarsest topology on $X_1 \times X_2 \times \dots \times X_n$ such that each projection $p_i : X_1 \times X_2 \times \dots \times X_n \rightarrow X_i$ is continuous. This observation will be of greater significance in the next section when we proceed to a discussion of products of an infinite number of topological spaces. \square

8.2.7 Corollary. For $n \geq 2$, the projection mappings of \mathbb{R}^n onto \mathbb{R} are continuous open mappings. \square

8.2.8 Proposition. Let $(X_1, \mathcal{T}_1), (X_2, \mathcal{T}_2), \dots, (X_n, \mathcal{T}_n)$ be topological spaces and $(X_1 \times X_2 \times \dots \times X_n, \mathcal{T})$ the product space. Then each (X_i, \mathcal{T}_i) is homeomorphic to a subspace of $(X_1 \times X_2 \times \dots \times X_n, \mathcal{T})$.

Proof. For each j , let a_j be any (fixed) element in X_j . For each i , define a mapping $f_i: (X_i, \mathcal{T}_i) \rightarrow (X_1 \times X_2 \times \dots \times X_n, \mathcal{T})$ by

$$f_i(x) = \langle a_1, a_2, \dots, a_{i-1}, x, a_{i+1}, \dots, a_n \rangle.$$

We claim that $f_i: (X_i, \mathcal{T}_i) \rightarrow (f_i(X_i), \mathcal{T}')$ is a homeomorphism, where \mathcal{T}' is the topology induced on $f_i(X_i)$ by \mathcal{T} . Clearly this mapping is one-to-one and onto. Let $U \in \mathcal{T}_i$. Then

$$\begin{aligned} f_i(U) &= \{a_1\} \times \{a_2\} \times \dots \times \{a_{i-1}\} \times U \times \{a_{i+1}\} \times \dots \times \{a_n\} \\ &= (X_1 \times X_2 \times \dots \times X_{i-1} \times U \times X_{i+1} \times \dots \times X_n) \cap \\ &\quad (\{a_1\} \times \{a_2\} \times \dots \times \{a_{i-1}\} \times X_i \times \{a_{i+1}\} \times \dots \times \{a_n\}) \\ &= (X_1 \times X_2 \times \dots \times X_{i-1} \times U \times X_{i+1} \times \dots \times X_n) \cap f_i(X_i) \\ &\in \mathcal{T}' \end{aligned}$$

since $X_1 \times X_2 \times \dots \times X_{i-1} \times U \times X_{i+1} \times \dots \times X_n \in \mathcal{T}$. So $U \in \mathcal{T}_i$ implies that $f_i(U) \in \mathcal{T}'$.

Finally, observe that the family

$$\{(U_1 \times U_2 \times \dots \times U_n) \cap f_i(X_i) : U_i \in \mathcal{T}_i, i = 1, \dots, n\}$$

is a basis for \mathcal{T}' , so to prove that f_i is continuous it suffices to verify that the inverse image under f_i of every member of this family is open in (X_i, \mathcal{T}_i) . But

$$\begin{aligned} f_i^{-1}[(U_1 \times U_2 \times \dots \times U_n) \cap f_i(X_i)] &= f_i^{-1}(U_1 \times U_2 \times \dots \times U_n) \cap f_i^{-1}(f_i(X_i)) \\ &= \begin{cases} U_i \cap X_i, & \text{if } a_j \in U_j, j \neq i \\ \emptyset, & \text{if } a_j \notin U_j, \text{ for some } j \neq i. \end{cases} \end{aligned}$$

As $U_i \cap X_i = U_i \in \mathcal{T}_i$ and $\emptyset \in \mathcal{T}_i$ we infer that f_i is continuous, and so we have the required result. \square

Notation. If X_1, X_2, \dots, X_n are sets then the product $X_1 \times X_2 \times \dots \times X_n$ is denoted by $\prod_{i=1}^n X_i$. If $(X_1, \mathcal{T}_1), (X_2, \mathcal{T}_2), \dots, (X_n, \mathcal{T}_n)$ are topological spaces, then the product space $(X_1, \mathcal{T}_1) \times (X_2, \mathcal{T}_2) \times \dots \times (X_n, \mathcal{T}_n)$ is denoted by $\prod_{i=1}^n (X_i, \mathcal{T}_i)$. \square

 Exercises 8.2

1. Prove that the euclidean topology on \mathbb{R} is finer than the finite-closed topology.
2. Let (X_i, \mathcal{T}_i) be a topological space, for $i = 1, \dots, n$. Prove that
 - (i) if $\prod_{i=1}^n (X_i, \mathcal{T}_i)$ is connected, then each (X_i, \mathcal{T}_i) is connected;
 - (ii) if $\prod_{i=1}^n (X_i, \mathcal{T}_i)$ is compact, then each (X_i, \mathcal{T}_i) is compact;
 - (iii) if $\prod_{i=1}^n (X_i, \mathcal{T}_i)$ is path-connected, then each (X_i, \mathcal{T}_i) is path-connected;
 - (iv) if $\prod_{i=1}^n (X_i, \mathcal{T}_i)$ is Hausdorff, then each (X_i, \mathcal{T}_i) is Hausdorff;
 - (v) if $\prod_{i=1}^n (X_i, \mathcal{T}_i)$ is a T_1 -space, then each (X_i, \mathcal{T}_i) is a T_1 -space.

3. Let (Y, \mathcal{T}) and (X_i, \mathcal{T}_i) , $i = 1, 2, \dots, n$ be topological spaces. Further for each i , let f_i be a mapping of (Y, \mathcal{T}) into (X_i, \mathcal{T}_i) . Prove that the mapping $f: (Y, \mathcal{T}) \rightarrow \prod_{i=1}^n (X_i, \mathcal{T}_i)$, given by

$$f(y) = \langle f_1(y), f_2(y), \dots, f_n(y) \rangle,$$

is continuous if and only if every f_i is continuous.

[Hint: Observe that $f_i = p_i \circ f$, where p_i is the projection mapping of $\prod_{j=1}^n (X_j, \mathcal{T}_j)$ onto (X_i, \mathcal{T}_i) .]

4. Let (X, d_1) and (Y, d_2) be metric spaces. Further let e be the metric on $X \times Y$ defined in Exercises 6.1 #4. Also let \mathcal{T} be the topology induced on $X \times Y$ by e . If d_1 and d_2 induce the topologies \mathcal{T}_1 and \mathcal{T}_2 on X and Y , respectively, and \mathcal{T}_3 is the product topology of $(X, \mathcal{T}_1) \times (Y, \mathcal{T}_2)$, prove that $\mathcal{T} = \mathcal{T}_3$. [This shows that [the product of any two metrizable spaces is metrizable](#).]
5. Let $(X_1, \mathcal{T}_1), (X_2, \mathcal{T}_2), \dots, (X_n, \mathcal{T}_n)$ be topological spaces. Prove that $\prod_{i=1}^n (X_i, \mathcal{T}_i)$ is a metrizable space if and only if each (X_i, \mathcal{T}_i) is metrizable.

[Hint: Use Exercises 6.1 #6, which says that every subspace of a metrizable space is metrizable, and Exercise 4 above.]

8.3 Tychonoff's Theorem for Finite Products

8.3.1 Theorem. (Tychonoff's Theorem for Finite Products) If $(X_1, \mathcal{T}_1), (X_2, \mathcal{T}_2), \dots, (X_n, \mathcal{T}_n)$ are compact spaces, then $\prod_{i=1}^n (X_i, \mathcal{T}_i)$ is a compact space.

Proof. Consider first the product of two compact spaces (X, \mathcal{T}_1) and (Y, \mathcal{T}_2) . Let $U_i, i \in I$ be any open covering of $X \times Y$. Then for each $x \in X$ and $y \in Y$, there exists an $i \in I$ such that $\langle x, y \rangle \in U_i$. So there is a basic open set $V(x, y) \times W(x, y)$, such that $V(x, y) \in \mathcal{T}_1, W(x, y) \in \mathcal{T}_2$ and $\langle x, y \rangle \in V(x, y) \times W(x, y) \subseteq U_i$.

As $\langle x, y \rangle$ ranges over all points of $X \times Y$ we obtain an open covering $V(x, y) \times W(x, y), x \in X, y \in Y$, of $X \times Y$ such that each $V(x, y) \times W(x, y)$ is a subset of some $U_i, i \in I$. Thus to prove $(X, \mathcal{T}_1) \times (Y, \mathcal{T}_2)$ is compact it suffices to find a finite subcovering of the open covering $V(x, y) \times W(x, y), x \in X, y \in Y$.

Now fix $x_0 \in X$ and consider the subspace $\{x_0\} \times Y$ of $X \times Y$. As seen in Proposition 8.2.8 this subspace is homeomorphic to (Y, \mathcal{T}_2) and so is compact. As $V(x_0, y) \times W(x_0, y), y \in Y$, is an open covering of $\{x_0\} \times Y$ it has a finite subcovering:

$$V(x_0, y_1) \times W(x_0, y_1), V(x_0, y_2) \times W(x_0, y_2), \dots, V(x_0, y_m) \times W(x_0, y_m).$$

Put $V(x_0) = V(x_0, y_1) \cap V(x_0, y_2) \cap \dots \cap V(x_0, y_m)$. Then we see that the set $V(x_0) \times Y$ is contained in the union of a finite number of sets of the form $V(x_0, y) \times W(x_0, y), y \in Y$.

Thus to prove $X \times Y$ is compact it suffices to show that $X \times Y$ is contained in a finite union of sets of the form $V(x) \times Y$. As each $V(x)$ is an open set containing $x \in X$, the family $V(x), x \in X$, is an open covering of the compact space (X, \mathcal{T}_1) . Therefore there exist x_1, x_2, \dots, x_k such that $X \subseteq V(x_1) \cup V(x_2) \cup \dots \cup V(x_k)$. Thus $X \times Y \subseteq (V(x_1) \times Y) \cup (V(x_2) \times Y) \cup \dots \cup (V(x_k) \times Y)$, as required. Hence $(X, \mathcal{T}_1) \times (Y, \mathcal{T}_2)$ is compact.

The proof is completed by induction. Suppose that the product of any N compact spaces is compact. Consider the product $(X_1, \mathcal{T}_1) \times (X_2, \mathcal{T}_2) \times \dots \times (X_{N+1}, \mathcal{T}_{N+1})$ of compact spaces $(X_i, \mathcal{T}_i), i = 1, \dots, N + 1$. Then

$$(X_1, \mathcal{T}_1) \times (X_2, \mathcal{T}_2) \times \dots \times (X_{N+1}, \mathcal{T}_{N+1}) \cong [(X_1, \mathcal{T}_1) \times \dots \times (X_N, \mathcal{T}_N)] \times (X_{N+1}, \mathcal{T}_{N+1}).$$

By our inductive hypothesis $(X_1, \mathcal{T}_1) \times \dots \times (X_N, \mathcal{T}_N)$ is compact, so the right-hand side is the product of two compact spaces and thus is compact. Therefore the left-hand side is also compact. This completes the induction and the proof of the theorem. \square

Using Proposition 7.2.1 and 8.2.5 (i) we immediately obtain:

8.3.2 Proposition. (Converse of Tychonoff's Theorem) Let $(X_1, \mathcal{T}_1), (X_2, \mathcal{T}_2), \dots, (X_n, \mathcal{T}_n)$ be topological spaces. If $\prod_{i=1}^n (X_i, \mathcal{T}_i)$ is compact, then each (X_i, \mathcal{T}_i) is compact. \square

We can now prove the previously stated Theorem 7.2.13.

8.3.3 Theorem. (Generalized Heine-Borel Theorem) A subset of \mathbb{R}^n , $n \geq 1$ is compact if and only if it is closed and bounded.

Proof. That any compact subset of \mathbb{R}^n is bounded can be proved in an analogous fashion to Proposition 7.2.8. Thus by Proposition 7.2.5 any compact subset of \mathbb{R}^n is closed and bounded.

Conversely let S be any closed bounded subset of \mathbb{R}^n . Then, by Exercises 7.2 #8, S is a closed subset of the product

$$\overbrace{[-M, M] \times [-M, M] \times \cdots \times [-M, M]}^{n \text{ terms}}$$

for some positive real number M . As each closed interval $[-M, M]$ is compact, by Corollary 7.2.3, Tychonoff's Theorem implies that the product space

$$[-M, M] \times [-M, M] \times \cdots \times [-M, M]$$

is also compact. As S is a closed subset of a compact set, it too is compact. \square

8.3.4 Example. Define the subspace \mathbb{S}^1 of \mathbb{R}^2 by

$$\mathbb{S}^1 = \{(x, y) : x^2 + y^2 = 1\}.$$

Then \mathbb{S}^1 is a closed bounded subset of \mathbb{R}^2 and thus is compact.

Similarly we define the **n-sphere** \mathbb{S}^n as the subspace of \mathbb{R}^{n+1} given by

$$\mathbb{S}^n = \{(x_1, x_2, \dots, x_{n+1}) : x_1^2 + x_2^2 + \cdots + x_{n+1}^2 = 1\}.$$

Then \mathbb{S}^n is a closed bounded subset of \mathbb{R}^{n+1} and so is compact. \square

8.3.5 Example. The subspace $\mathbb{S}^1 \times [0, 1]$ of \mathbb{R}^3 is the product of two compact spaces and so is compact. (Convince yourself that $\mathbb{S}^1 \times [0, 1]$ is the surface of a cylinder.) \square

Exercises 8.3

1. A topological space (X, \mathcal{T}) is said to be **locally compact** if each point $x \in X$ has at least one neighbourhood which is compact. Prove that
 - (i) Every compact space is locally compact.
 - (ii) \mathbb{R} and \mathbb{Z} are locally compact (but not compact).
 - (iii) Every discrete space is locally compact.
 - (iv) If $(X_1, \mathcal{T}_1), (X_2, \mathcal{T}_2), \dots, (X_n, \mathcal{T}_n)$ are locally compact spaces, then $\prod_{i=1}^n (X_i, \mathcal{T}_i)$ is locally compact.
 - (v) Every closed subspace of a locally compact space is locally compact.
 - (vi) A continuous image of a locally compact space is not necessarily locally compact.
 - (vii) If f is a continuous open mapping of a locally compact space (X, \mathcal{T}) onto a topological space (Y, \mathcal{T}_1) , then (Y, \mathcal{T}_1) is locally compact.
 - (viii) If $(X_1, \mathcal{T}_1), (X_2, \mathcal{T}_2), \dots, (X_n, \mathcal{T}_n)$ are topological spaces such that $\prod_{i=1}^n (X_i, \mathcal{T}_i)$ is locally compact, then each (X_i, \mathcal{T}_i) is locally compact.

- 2.* Let (Y, \mathcal{T}_1) be a locally compact subspace of the Hausdorff space (X, \mathcal{T}) . If Y is dense in (X, \mathcal{T}) , prove that Y is open in (X, \mathcal{T}) .
 [Hint: Use Exercises 3.2 #9]

8.4 Products and Connectedness

8.4.1 Definition. Let (X, \mathcal{T}) be a topological space and let x be any point in X . The **component in X of x** , $C_X(x)$, is defined to be the union of all connected subsets of X which contain x .

8.4.2 Proposition. Let x be any point in a topological space (X, \mathcal{T}) . Then $C_X(x)$ is connected.

Proof. Let $\{C_i : i \in I\}$ be the family of all connected subsets of (X, \mathcal{T}) which contain x . (Observe that $\{x\} \in \{C_i : i \in I\}$.) Then $C_X(x) = \bigcup_{i \in I} C_i$.

Let O be a subset of $C_X(x)$ which is clopen in the topology induced on $C_X(x)$ by \mathcal{T} . Then $O \cap C_i$ is clopen in the induced topology on C_i , for each i .

But as each C_i is connected, $O \cap C_i = C_i$ or \emptyset , for each i . If $O \cap C_j = C_j$ for some $j \in I$, then $x \in O$. So, in this case, $O \cap C_i \neq \emptyset$, for all $i \in I$ as each C_i contains x . Therefore $O \cap C_i = C_i$, for all $i \in I$ or $O \cap C_i = \emptyset$, for all $i \in I$; that is, $O = C_X(x)$ or $O = \emptyset$.

So $C_X(x)$ has no proper non-empty clopen subset and hence is connected. \square

8.4.3 Remark. We see from Definition 8.4.1 and Proposition 8.4.2 that $C_X(x)$ is the largest connected subset of X which contains x . \square

8.4.4 Lemma. Let a and b be points in a topological space (X, \mathcal{T}) . If there exists a connected set C containing both a and b then $C_X(a) = C_X(b)$.

Proof. By Definition 8.4.1, $C_X(a) \supseteq C$ and $C_X(b) \supseteq C$. Therefore $a \in C_X(b)$.

By Proposition 8.4.2, $C_X(b)$ is connected and so is a connected set containing a . Thus, by Definition 8.4.1, $C_X(a) \supseteq C_X(b)$.

Similarly $C_X(b) \supseteq C_X(a)$, and we have shown that $C_X(a) = C_X(b)$. \square

8.4.5 Proposition. Let $(X_1, \mathcal{T}_1), (X_2, \mathcal{T}_2), \dots, (X_n, \mathcal{T}_n)$ be topological spaces. Then $\prod_{i=1}^n (X_i, \mathcal{T}_i)$ is connected if and only if each (X_i, \mathcal{T}_i) is connected.

Proof. To show that the product of a finite number of connected spaces is connected, it suffices to prove that the product of any two connected spaces is connected, as the result then follows by induction.

So let (X, \mathcal{T}) and (Y, \mathcal{T}_1) be connected spaces and $\langle x_0, y_0 \rangle$ any point in the product space $(X \times Y, \mathcal{T}_2)$. Let $\langle x_1, y_1 \rangle$ be any other point in $X \times Y$. Then the subspace $\{x_0\} \times Y$ of $(X \times Y, \mathcal{T})$ is homeomorphic to the connected space (Y, \mathcal{T}_1) and so is connected.

Similarly the subspace $X \times \{y_1\}$ is connected. Furthermore, $\langle x_0, y_1 \rangle$ lies in the connected space $\{x_0\} \times Y$, so $C_{X \times Y}(\langle x_0, y_1 \rangle) \supseteq \{x_0\} \times Y \ni \langle x_0, y_0 \rangle$, while $\langle x_0, y_1 \rangle \in X \times \{y_1\}$, and so $C_{X \times Y}(\langle x_0, y_1 \rangle) \supseteq X \times \{y_1\} \ni \langle x_1, y_1 \rangle$.

Thus $\langle x_0, y_0 \rangle$ and $\langle x_1, y_1 \rangle$ lie in the connected set $C_{X \times Y}(\langle x_0, y_1 \rangle)$, and so by Lemma 8.4.4, $C_{X \times Y}(\langle x_0, y_0 \rangle) = C_{X \times Y}(\langle x_1, y_1 \rangle)$. In particular, $\langle x_1, y_1 \rangle \in C_{X \times Y}(\langle x_0, y_0 \rangle)$. As $\langle x_1, y_1 \rangle$ was an arbitrary point in $X \times Y$, we have that $C_{X \times Y}(\langle x_0, y_0 \rangle) = X \times Y$. Hence $(X \times Y, \mathcal{T}_2)$ is connected.

Conversely if $\prod_{i=1}^n (X_i, \mathcal{T}_i)$ is connected then Propositions 8.2.5 and 5.2.1 imply that each (X_i, \mathcal{T}_i) is connected. \square

8.4.6 Remark. In Exercises 5.2 #9 the following result appears: For any point x in any topological space (X, \mathcal{T}) , the component $C_X(x)$ is a closed set. \square

8.4.7 Definition. A topological space is said to be a **continuum** if it is compact and connected.

As an immediate consequence of Theorem 8.3.1 and Propositions 8.4.5 and 8.3.2 we have the following proposition.

8.4.8 Proposition. Let $(X_1, \mathcal{T}_1), (X_2, \mathcal{T}_2), \dots, (X_n, \mathcal{T}_n)$ be topological spaces. Then $\prod_{i=1}^n (X_i, \mathcal{T}_i)$ is a continuum if and only if each (X_i, \mathcal{T}_i) is a continuum. \square

Exercises 8.4

1. A topological space (X, \mathcal{T}) is said to be a **compactum** if it is compact and metrizable. Let $(X_1, \mathcal{T}_1), (X_2, \mathcal{T}_2), \dots, (X_n, \mathcal{T}_n)$ be topological spaces. Using Exercises 8.2#5, prove that $\prod_{i=1}^n (X_i, \mathcal{T}_i)$ is a compactum if and only if each (X_i, \mathcal{T}_i) is a compactum.
2. Let (X, d) be a metric space and \mathcal{T} the topology induced on X by d .
 - (i) Prove that the function d from the product space $(X, \mathcal{T}) \times (X, \mathcal{T})$ into \mathbb{R} is continuous.
 - (ii) Using (i) show that if the metrizable space (X, \mathcal{T}) is connected and X has at least 2 points, then X has the uncountable number of points.
3. If (X, \mathcal{T}) and (Y, \mathcal{T}_1) are path-connected spaces, prove that the product space $(X, \mathcal{T}) \times (Y, \mathcal{T}_1)$ is path-connected.
4. (i) Let $x = (x_1, x_2, \dots, x_n)$ be any point in the product space $(Y, \mathcal{T}) = \prod_{i=1}^n (X_i, \mathcal{T}_i)$. Prove that $C_Y(x) = C_{X_1}(x_1) \times C_{X_2}(x_2) \times \dots \times C_{X_n}(x_n)$.
 - (ii) Deduce from (i) and Exercises 5.2 #10 that $\prod_{i=1}^n (X_i, \mathcal{T}_i)$ is totally disconnected if and only if each (X_i, \mathcal{T}_i) is totally disconnected.

5. A topological space (X, \mathcal{T}) is said to be **locally connected** if it has a basis B consisting of connected (open) sets.
- (i) Verify that \mathbb{Z} is a locally connected space which is not connected.
 - (ii) Show that \mathbb{R}^n and \mathbb{S}^n are locally connected, for all $n \geq 1$.
 - (iii) Let (X, \mathcal{T}) be the subspace of \mathbb{R}^2 consisting of the points in the line segments joining $\langle 0, 1 \rangle$ to $\langle 0, 0 \rangle$ and to all the points $\langle \frac{1}{n}, 0 \rangle$, $n = 1, 2, 3, \dots$. Show that (X, \mathcal{T}) is connected but not locally connected.
 - (iv) Prove that every open subset of a locally connected space is locally connected.
 - (v) Let $(X_1, \mathcal{T}_1), (X_2, \mathcal{T}_2), \dots, (X_n, \mathcal{T}_n)$ be topological spaces. Prove that $\prod_{i=1}^n (X_i, \mathcal{T}_i)$ is locally connected if and only if each (X_i, \mathcal{T}_i) is locally connected.

8.5 Fundamental Theorem of Algebra

In this section we give an application of topology to another branch of mathematics. We show how to use compactness and the Generalized Heine-Borel Theorem to prove the Fundamental Theorem of Algebra.

8.5.1 Theorem. (The Fundamental Theorem of Algebra) Every polynomial $f(z) = a_n z^n + a_{n-1} z^{n-1} + \dots + a_1 z + a_0$, where each a_i is a complex number, $a_n \neq 0$, and $n \geq 1$, has a root; that is, there exists a complex number z_0 s.t. $f(z_0) = 0$.

Proof.

$$\begin{aligned}
 |f(z)| &= |a_n z^n + a_{n-1} z^{n-1} + \dots + a_0| \\
 &\geq |a_n| |z|^n - |z|^{n-1} \left[|a_{n-1}| + \frac{|a_{n-2}|}{|z|} + \dots + \frac{|a_0|}{|z|^{n-1}} \right] \\
 &\geq |a_n| |z|^n - |z|^{n-1} [|a_{n-1}| + |a_{n-2}| + \dots + |a_0|], \quad \text{for } |z| \geq 1 \\
 &= |z|^{n-1} [|a_n| |z| - R], \quad \text{for } |z| \geq 1 \text{ and } R = |a_{n-1}| + \dots + |a_0| \\
 &\geq |z|^{n-1}, \quad \text{for } |z| \geq \max \left\{ 1, \frac{R+1}{|a_n|} \right\}. \tag{1}
 \end{aligned}$$

If we put $p_0 = |f(0)| = |a_0|$ then, by inequality (1), there exists a $T > 0$ such that

$$|f(z)| > p_0, \quad \text{for all } |z| > T \tag{2}$$

Consider the set $D = \{z : z \in \text{complex plane and } |z| \leq T\}$. This is a closed bounded subset of the complex plane $\mathbb{C} = \mathbb{R}^2$ and so, by the Generalized Heine-Borel Theorem, is compact. Therefore, by Proposition 7.2.14, the continuous function $|f| : D \rightarrow \mathbb{R}$ has a least value at some point z_0 . So

$$|f(z_0)| \leq |f(z)|, \quad \text{for all } z \in D.$$

By (2), for all $z \notin D$, $|f(z)| > p_0 = |f(0)| \geq |f(z_0)|$. Therefore

$$|f(z_0)| \leq |f(z)|, \quad \text{for all } z \in \mathbb{C} \quad (3)$$

So we are required to prove that $f(z_0) = 0$. To do this it is convenient to perform a 'translation'. Put $P(z) = f(z + z_0)$. Then, by (2),

$$|P(0)| \leq |P(z)|, \quad \text{for all } z \in \mathbb{C} \quad (4)$$

The problem of showing that $f(z_0) = 0$ is now converted to the equivalent one of proving that $P(0) = 0$.

Now $P(z) = b_n z^n + b_{n-1} z^{n-1} \cdots + b_0$, $b_i \in \mathbb{C}$. So $P(0) = b_0$. We shall show that $b_0 = 0$.

Suppose $b_0 \neq 0$. Then

$$P(z) = b_0 + b_k z^k + z^{k+1} Q(z), \quad (5)$$

where $Q(z)$ is a polynomial and b_k is the smallest $b_i \neq 0$, $i > 0$.

e.g. if $P(z) = 10z^7 + 6z^5 + 3z^4 + 4z^3 + 2z^2 + 1$, then $b_0 = 1$, $b_k = 2$, ($b_1 = 0$), and

$$P(z) = 1 + 2z^2 + z^3 \overbrace{(4 + 3z + 6z^2 + 10z^4)}^{Q(z)}.$$

Let $w \in \mathbb{C}$ be a k^{th} root of the number $-b_0/b_k$; that is, $w^k = -b_0/b_k$.

As $Q(z)$ is a polynomial, for t a real number,

$$t|Q(tw)| \rightarrow 0, \quad \text{as } t \rightarrow 0$$

This implies that $t|w^{k+1}Q(tw)| \rightarrow 0$ as $t \rightarrow 0$.

So there exists a real number t_0 with $0 < t_0 < 1$ such that

$$t_0 |w^{k+1}Q(t_0w)| < |b_0| \quad (6)$$

$$\begin{aligned}\text{So, by (5), } P(t_0w) &= b_0 + b_k(t_0w)^k + (t_0w)^{k+1}Q(t_0w) \\ &= b_0 + b_k \left[t_0^k \left(\frac{-b_0}{b_k} \right) \right] + (t_0w)^{k+1}Q(t_0w) \\ &= b_0(1 - t_0^k) + (t_0w)^{k+1}Q(t_0w)\end{aligned}$$

$$\begin{aligned}\text{Therefore } |P(t_0w)| &\leq (1 - t_0^k)|b_0| + t_0^{k+1}|w^{k+1}Q(t_0w)| \\ &< (1 - t_0^k)|b_0| + t_0^k|b_0|, \quad \text{by (6)} \\ &= |b_0| \\ &= |P(0)|\end{aligned}\tag{7}$$

But (7) contradicts (4). Therefore the supposition that $b_0 \neq 0$ is false; that is, $P(0) = 0$, as required. \square

8.6 Postscript

As mentioned in the Introduction, this is one of three chapters devoted to product spaces. The easiest case is that of finite products. In the next chapter we study countably infinite products and in Chapter 10, the general case. The most important result proved in this section is Tychonoff's Theorem¹. In Chapter 10 this is generalized to arbitrary sized products.

The second result we called a theorem here is the Generalized Heine-Borel Theorem which characterizes the compact subsets of \mathbb{R}^n as those which are closed and bounded.

Exercises 8.3 #1 introduced the notion of locally compact topological space. Such spaces play a central role in topological group theory.

Our study of connectedness has been furthered in this section by defining the component of a point. This allows us to partition any topological space into connected sets. In a connected space like \mathbb{R}^n the component of any point is the whole space. At the other end of the scale, the components in any totally disconnected space, for example, \mathbb{Q} , are all singleton sets.

As mentioned above, compactness has a local version. So too does connectedness. Exercises 8.4 #5 defined locally connected. However, while every compact space is locally compact, not every connected space is locally connected. Indeed many properties \mathcal{P} have local versions called **locally \mathcal{P}** , and \mathcal{P} usually does not imply locally \mathcal{P} and locally \mathcal{P} usually does not imply \mathcal{P} .

Towards the end of the chapter we gave a topological proof of the Fundamental Theorem of Algebra. The fact that a theorem in one branch of mathematics can be proved using methods from another branch is but one indication of why mathematics should not be compartmentalized. While you may have separate courses on algebra, complex analysis, and number theory these topics are, in fact, interrelated.

In Appendix 5 we introduce the notion of a topological group, that is a set with the structure of both a topological space and a group, and with the two structures related in an appropriate manner. Topological group theory is a rich and interesting branch of mathematics. Appendix 5 can be studied using the prerequisite knowledge in this chapter.

For those who know some category theory, we observe that the category of topological spaces and continuous mappings has both products and coproducts. The products in the category are indeed the products of the topological spaces. You may care to identify the coproducts.

¹You should have noticed how sparingly we use the word "theorem", so when we do use that term it is because the result is important.

Chapter 9

Countable Products

Introduction

Intuition tells us that a curve has zero area. Thus you should be astonished to learn of the existence of space-filling curves. We attack this topic using the curious space known as the Cantor Space. It is surprising that an examination of this space leads us to a better understanding of the properties of the unit interval $[0, 1]$.

Previously we have studied finite products of topological spaces. In this chapter we extend our study to countably infinite products of topological spaces. This leads us into wonderfully rich territory of which space-filling curves is but one example.

9.1 The Cantor Set

9.1.1 Remark. We now construct a very curious (but useful) set known as the **Cantor Set**. Consider the closed unit interval $[0,1]$ and delete from it the open interval $(\frac{1}{2}, \frac{2}{3})$, which is the middle third, and denote the remaining closed set by G_1 . So

$$G_1 = [0, \frac{1}{3}] \cup [\frac{2}{3}, 1].$$

Next, delete from G_1 the open intervals $(\frac{1}{9}, \frac{2}{9})$ and $(\frac{7}{9}, \frac{8}{9})$ which are the middle third of its two pieces and denote the remaining closed set by G_2 . So

$$G_2 = [0, \frac{1}{9}] \cup [\frac{2}{9}, \frac{1}{3}] \cup [\frac{2}{3}, \frac{7}{9}] \cup [\frac{8}{9}, 1].$$

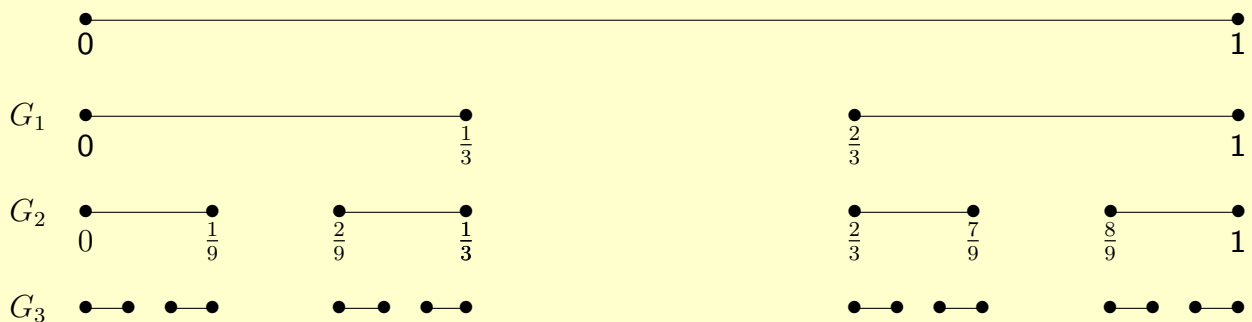

If we continue in this way, at each stage deleting the open middle third of each closed interval remaining from the previous stage we obtain a descending sequence of closed sets

$$G_1 \supset G_2 \supset G_3 \supset \dots G_n \supset \dots$$

The **Cantor Set**, G , is defined by

$$G = \bigcap_{n=1}^{\infty} G_n$$

and, being the intersection of closed sets, is a closed subset of $[0,1]$. As $[0,1]$ is compact, the **Cantor Space**, (G, \mathcal{T}) , (that is, G with the subspace topology) is compact. [The Cantor Set is named after the famous set theorist, Georg Cantor (1845–1918).]

It is useful to represent the Cantor Set in terms of real numbers written to base 3; that is, ternaries. You are familiar with the decimal expansion of real numbers which uses base 10. Today one cannot avoid computers which use base 2. But for the Cantor Set, base 3 is what is best.

In the ternary system, $76\frac{5}{81}$ would be written as 2211·0012, since this represents

$$2 \cdot 3^3 + 2 \cdot 3^2 + 1 \cdot 3^1 + 1 \cdot 3^0 + 0 \cdot 3^{-1} + 0 \cdot 3^{-2} + 1 \cdot 3^{-3} + 2 \cdot 3^{-4}.$$

So a number x in $[0, 1]$ is represented by the base 3 number $\cdot a_1 a_2 a_3 \dots a_n \dots$, where

$$x = \sum_{n=1}^{\infty} \frac{a_n}{3^n}, \quad a_n \in \{0, 1, 2\}, \quad \text{for each } n \in \mathbb{N}.$$

So as $\frac{1}{2} = \sum_{n=1}^{\infty} \frac{1}{3^n}$, $\frac{1}{3} = \sum_{n=2}^{\infty} \frac{2}{3^n}$, and $1 = \sum_{n=1}^{\infty} \frac{2}{3^n}$, we see that their ternary forms are given by

$$\frac{1}{2} = 0 \cdot 11111 \dots; \quad \frac{1}{3} = 0 \cdot 02222 \dots; \quad 1 = 0 \cdot 2222 \dots$$

(Of course another ternary expression for $\frac{1}{3}$ is $0 \cdot 10000 \dots$ and another for 1 is $1 \cdot 0000 \dots$.)

Turning again to the Cantor Set, G , it should be clear that an element of $[0, 1]$ is in G if and only if it can be written in ternary form with $a_n \neq 1$, for every $n \in \mathbb{N}$. So $\frac{1}{2} \notin G$, $\frac{5}{81} \notin G$, $\frac{1}{3} \in G$, and $1 \in G$.

Thus we have a function f from the Cantor Set into the set of all sequences of the form $\langle a_1, a_2, a_3, \dots, a_n, \dots \rangle$, where each $a_i \in \{0, 2\}$ and f is one-to-one and onto. Later on we shall make use of this function f . □

Exercises 9.1

1. (a) Write down ternary expansions for the following numbers:

(i) $21\frac{5}{243}$; (ii) $\frac{7}{9}$; (iii) $\frac{1}{13}$.

(b) Which real numbers have the following ternary expressions:

(i) $0 \cdot \overline{02} = 0 \cdot 020202 \dots$; (ii) $0 \cdot \overline{110}$; (iii) $0 \cdot \overline{012}$?

(c) Which of the numbers appearing in (a) and (b) lie in the Cantor Set?

2. Let x be a point in a topological space (X, \mathcal{T}) . Then x is said to be an **isolated point** if $x \in X \setminus X'$; that is, x is not a limit point of X . The space (X, \mathcal{T}) is said to be **perfect** if it has no isolated points. Prove that the Cantor Space is a compact totally disconnected perfect space.

[It can be shown that any non-empty compact totally disconnected metrizable perfect space is homeomorphic to the Cantor Space. See, for example, Exercise 6.2A(c) of Engelking [77].

9.2 The Product Topology

9.2.1 Definition. Let $(X_1, \mathcal{T}_1), (X_2, \mathcal{T}_2), \dots, (X_n, \mathcal{T}), \dots$ be a countably infinite family of topological spaces. Then the **product**, $\prod_{i=1}^{\infty} X_i$, of the sets $X_i, i \in \mathbb{N}$ consists of all the infinite sequences $\langle x_1, x_2, x_3, \dots, x_n, \dots \rangle$, where $x_i \in X_i$ for all i . (The infinite sequence $\langle x_1, x_2, \dots, x_n, \dots \rangle$ is sometimes written as $\prod_{i=1}^{\infty} x_i$.) The **product space**, $\prod_{i=1}^{\infty} (X_i, \mathcal{T}_i)$, consists of the product $\prod_{i=1}^{\infty} X_i$ with the topology \mathcal{T} having as its basis the family

$$B = \left\{ \prod_{i=1}^{\infty} O_i : O_i \in \mathcal{T}_i \text{ and } O_i = X_i \text{ for all but a finite number of } i. \right\}$$

The topology \mathcal{T} is called the **product topology**.

So a basic open set is of the form

$$O_1 \times O_2 \times \cdots \times O_n \times X_{n+1} \times X_{n+2} \times \cdots$$

WARNING. It should be obvious that **a product of open sets need not be open in the product topology \mathcal{T}** . In particular, if $O_1, O_2, O_3, \dots, O_n, \dots$ are such that each $O_i \in \mathcal{T}_i$, and $O_i \neq X_i$ for all i , then $\prod_{i=1}^{\infty} O_i$ cannot be expressed as a union of members of \mathcal{B} and so is not open in the product space $(\prod_{i=1}^{\infty} X_i, \mathcal{T})$.

9.2.2 Remark. Why do we choose to define the product topology as in Definition 9.2.1? The answer is that only with this definition do we obtain Tychonoff's Theorem (for infinite products), which says that any product of compact spaces is compact. And this result is extremely important for applications.

9.2.3 Example. Let $(X_1, \mathcal{T}_1), \dots, (X_n, \mathcal{T}_n), \dots$ be a countably infinite family of topological spaces. Then the **box topology** \mathcal{T}' on the product $\prod_{i=1}^{\infty} X_i$, is that topology having as its basis the family

$$B' = \left\{ \prod_{i=1}^{\infty} O_i : O_i \in \mathcal{T}_i \right\}.$$

It is readily seen that if each (X_i, \mathcal{T}_i) is a discrete space, then the box product $(\prod_{i=1}^{\infty} X_i, \mathcal{T}')$ is a discrete space. So if each (X_i, \mathcal{T}) is a finite set with the discrete topology, then $(\prod_{i=1}^{\infty} X_i, \mathcal{T}')$ is an infinite discrete space, which is certainly not compact. So we have a box product of the compact spaces (X_i, \mathcal{T}_i) being a non-compact space. \square

Another justification for our choice of definition of the product topology is the next proposition which is the analogue for countably infinite products of Proposition 8.2.5.

9.2.4 Proposition. Let $(X_1, \mathcal{T}_1), (X_2, \mathcal{T}_2), \dots, (X_n, \mathcal{T}_n), \dots$ be a countably infinite family of topological spaces and $(\prod_{i=1}^{\infty} X_i, \mathcal{T})$ their product space. For each i , let $p_i: \prod_{j=1}^{\infty} X_j \rightarrow X_i$ be the projection mapping; that is $p_i(\langle x_1, x_2, \dots, x_n, \dots \rangle) = x_i$ for each $\langle x_1, x_2, \dots, x_n, \dots \rangle \in \prod_{j=1}^{\infty} X_j$. Then

- (i) each p_i is a continuous surjective open mapping, and
- (ii) \mathcal{T} is the coarsest topology on the set $\prod_{j=1}^{\infty} X_j$ such that each p_i is continuous.

Proof. The proof is analogous to that of Proposition 8.2.5 and so left as an exercise. \square

We shall use the next proposition a little later.

9.2.5 Proposition. Let (X_i, \mathcal{T}_i) and (Y_i, \mathcal{T}'_i) , $i \in \mathbb{N}$, be countably infinite families of topological spaces having product spaces $(\prod_{i=1}^{\infty} X_i, \mathcal{T})$ and $(\prod_{i=1}^{\infty} Y_i, \mathcal{T}')$, respectively. If the mapping $h_i: (X_i, \mathcal{T}_i) \rightarrow (Y_i, \mathcal{T}'_i)$ is continuous for each $i \in \mathbb{N}$, then so is the mapping $h: (\prod_{i=1}^{\infty} X_i, \mathcal{T}) \rightarrow (\prod_{i=1}^{\infty} Y_i, \mathcal{T}')$ given by $h: (\prod_{i=1}^{\infty} x_i) = \prod_{i=1}^{\infty} h_i(x_i)$; that is, $h(\langle x_1, x_2, \dots, x_n, \dots \rangle) = \langle h_1(x_1), h_2(x_2), \dots, h_n(x_n), \dots \rangle$.

Proof. It suffices to show that if O is a basic open set in $(\prod_{i=1}^{\infty} Y_i, \mathcal{T}')$, then $h^{-1}(O)$ is open in $(\prod_{i=1}^{\infty} X_i, \mathcal{T})$. Consider the basic open set $U_1 \times U_2 \times \dots \times U_n \times Y_{n+1} \times Y_{n+2} \times \dots$ where $U_i \in \mathcal{T}'_i$, for $i = 1, \dots, n$. Then

$$h^{-1}(U_1 \times \dots \times U_n \times Y_{n+1} \times Y_{n+2} \times \dots) = h_1^{-1}(U_1) \times \dots \times h_n^{-1}(U_n) \times X_{n+1} \times X_{n+2} \times \dots$$

and the set on the right hand side is in \mathcal{T} , since the continuity of each h_i implies $h_i^{-1}(U_i) \in \mathcal{T}_i$, for $i = 1, \dots, n$. So h is continuous. \square

Exercises 9.2

1. For each $i \in \mathbb{N}$, let C_i be a closed subset of a topological space (X_i, \mathcal{T}_i) . Prove that $\prod_{i=1}^{\infty} C_i$ is a closed subset of $\prod_{i=1}^{\infty} (X_i, \mathcal{T}_i)$.

2. If in Proposition 9.2.5 each mapping h_i is also
- one-to-one,
 - onto,
 - onto and open,
 - a homeomorphism,
- prove that h is respectively
- one-to-one,
 - onto,
 - onto and open,
 - a homeomorphism.
3. Let (X_i, \mathcal{T}_i) , $i \in \mathbb{N}$, be a countably infinite family of topological spaces. Prove that each (X_i, \mathcal{T}_i) is homeomorphic to a subspace of $\prod_{i=1}^{\infty} (X_i, \mathcal{T}_i)$.
[Hint: See Proposition 8.12].
4. (a) Let (X_i, \mathcal{T}_i) , $i \in \mathbb{N}$, be topological spaces. If each (X_i, \mathcal{T}_i) is (i) a Hausdorff space, (ii) a T_1 -space, (iii) a T_0 -space, prove that $\prod_{i=1}^{\infty} (X_i, \mathcal{T}_i)$ is respectively (i) a Hausdorff space, (ii) a T_1 -space, (iii) a T_0 -space.
- (b) Using Exercise 3 above, prove the converse of the statements in (a).
5. Let (X_i, \mathcal{T}_i) , $i \in \mathbb{N}$, be a countably infinite family of topological spaces. Prove that $\prod_{i=1}^{\infty} (X_i, \mathcal{T}_i)$ is a discrete space if and only if each (X_i, \mathcal{T}_i) is discrete and all but a finite number of the X_i , $i \in \mathbb{N}$ are singleton sets.
6. For each $i \in \mathbb{N}$, let (X_i, \mathcal{T}_i) be a topological space. Prove that
- if $\prod_{i=1}^{\infty} (X_i, \mathcal{T}_i)$ is compact, then each (X_i, \mathcal{T}_i) is compact;
 - if $\prod_{i=1}^{\infty} (X_i, \mathcal{T}_i)$ is connected, then each (X_i, \mathcal{T}_i) is connected;
 - if $\prod_{i=1}^{\infty} (X_i, \mathcal{T}_i)$ is locally compact, then each (X_i, \mathcal{T}_i) is locally compact and all but a finite number of (X_i, \mathcal{T}_i) are compact.

9.3 The Cantor Space and the Hilbert Cube

9.3.1 Remark. We now return to the Cantor Space and prove that it is homeomorphic to a countably infinite product of two-point spaces.

For each $i \in \mathbb{N}$ we let (A_i, \mathcal{T}_i) be the set $\{0, 2\}$ with the discrete topology, and consider the product space $(\prod_{i=1}^{\infty} A_i, \mathcal{T}')$. We show in the next proposition that it is homeomorphic to the Cantor Space (G, \mathcal{T}) .

9.3.2 Proposition. Let (G, \mathcal{T}) be the Cantor Space and $(\prod_{i=1}^{\infty} A_i, \mathcal{T}')$ be as in Remark 9.3.1. Then the map $f: (G, \mathcal{T}) \rightarrow (\prod_{i=1}^{\infty} A_i, \mathcal{T}')$ given by $f(\sum_{n=1}^{\infty} \frac{a_n}{3^n}) = \langle a_1, a_2, \dots, a_n, \dots \rangle$ is a homeomorphism.

Proof. We have already noted in Remark 9.1.1 that f is one-to-one and onto. As (G, \mathcal{T}) is compact and $(\prod_{i=1}^{\infty} A_i, \mathcal{T}')$ is Hausdorff (Exercises 9.2 #4) Exercises 7.2 #6 says that f is a homeomorphism if it is continuous.

To prove the continuity of f it suffices to show for any basic open set $U = U_1 \times U_2 \times \dots \times U_N \times A_{N+1} \times A_{N+2} \times \dots$ and any point $a = \langle a_1, a_2, \dots, a_n, \dots \rangle \in U$ there exists an open set $W \ni \sum_{n=1}^{\infty} \frac{a_n}{3^n}$ such that $f(W) \subseteq U$.

Consider the open interval $(\sum_{n=1}^{\infty} \frac{a_n}{3^n} - \frac{1}{3^{N+2}}, \sum_{n=1}^{\infty} \frac{a_n}{3^n} + \frac{1}{3^{N+2}})$ and let W be the intersection of this open interval with G . Then W is open in (G, \mathcal{T}) and if $x = \sum_{n=1}^{\infty} \frac{x_n}{3^n} \in W$, then $x_i = a_i$, for $i = 1, 2, \dots, N$. So $f(x) \in U_1 \times U_2 \times \dots \times U_N \times A_{N+1} \times A_{N+2} \times \dots$, and thus $f(W) \subseteq U$, as required. \square

As indicated earlier, we shall in due course prove that any product of compact spaces is compact – that is, Tychonoff's Theorem. However in view of Proposition 9.3.2 we can show, trivially, that the product of a countable number of homeomorphic copies of the Cantor Space is homeomorphic to the Cantor Space, and hence is compact.

9.3.3 Proposition. Let (G_i, \mathcal{T}_i) , $i \in \mathbb{N}$, be a countably infinite family of topological spaces each of which is homeomorphic to the Cantor Space (G, \mathcal{T}) . Then

$$(G, \mathcal{T}) \cong \prod_{i=1}^{\infty} (G_i, \mathcal{T}_i) \cong \prod_{i=1}^n (G_i, \mathcal{T}_i), \quad \text{for each } n \in \mathbb{N}.$$

Proof. Firstly we verify that $(G, \mathcal{T}) \cong (G_1, \mathcal{T}_1) \times (G_2, \mathcal{T}_2)$. This is, by virtue of Proposition 9.3.2, equivalent to showing that

$$\prod_{i=1}^{\infty} (A_i, \mathcal{T}_i) \cong \prod_{i=1}^{\infty} (A_i, \mathcal{T}_i) \times \prod_{i=1}^{\infty} (A_i, \mathcal{T}_i)$$

where each (A_i, \mathcal{T}_i) is the set $\{0, 2\}$ with the discrete topology.

Now we define a function θ from the set $\prod_{i=1}^{\infty} (A_i, \mathcal{T}_i) \times \prod_{i=1}^{\infty} (A_i, \mathcal{T}_i)$ to the set $\prod_{i=1}^{\infty} (A_i, \mathcal{T}_i)$ by

$$\theta(\langle a_1, a_2, a_3, \dots \rangle, \langle b_1, b_2, b_3, \dots \rangle) \longrightarrow \langle a_1, b_1, a_2, b_2, a_3, b_3, \dots \rangle$$

It is readily verified that θ is a homeomorphism and so $(G_1, \mathcal{T}_1) \times (G_2, \mathcal{T}_2) \cong (G, \mathcal{T})$. By induction, then, $(G, \mathcal{T}) \cong \prod_{i=1}^n (G_i, \mathcal{T}_i)$, for every positive integer n .

Turning to the infinite product case, define the mapping

$$\phi : \left[\prod_{i=1}^{\infty} (A_i, \mathcal{T}_i) \times \prod_{i=1}^{\infty} (A_i, \mathcal{T}_i) \times \prod_{i=1}^{\infty} (A_i, \mathcal{T}_i) \times \dots \right] \longrightarrow \prod_{i=1}^{\infty} (A_i, \mathcal{T}_i)$$

by

$$\begin{aligned} \phi(\langle a_1, a_2, \dots \rangle, \langle b_1, b_2, \dots \rangle, \langle c_1, c_2, \dots \rangle, \langle d_1, d_2, \dots \rangle, \langle e_1, e_2, \dots \rangle, \dots) \\ = \langle a_1, a_2, b_1, a_3, b_2, c_1, a_4, b_3, c_2, d_1, a_5, b_4, c_3, d_2, e_1, \dots \rangle. \end{aligned}$$

Again it is easily verified that ϕ is a homeomorphism, and the proof is complete. \square

9.3.4 Remark. It should be observed that the statement

$$(G, \mathcal{T}) \cong \prod_{i=1}^{\infty} (G_i, \mathcal{T}_i)$$

in Proposition 9.3.3 is perhaps more transparent if we write it as

$$(A, \mathcal{T}) \times (A, \mathcal{T}) \times \dots \cong [(A, \mathcal{T}) \times (A, \mathcal{T}) \times \dots] \times [(A, \mathcal{T}) \times (A, \mathcal{T}) \times \dots] \times \dots$$

where (A, \mathcal{T}) is the set $\{0, 2\}$ with the discrete topology. \square

9.3.5 Proposition. The topological space $[0, 1]$ is a continuous image of the Cantor Space (G, \mathcal{T}) .

Proof. In view of Proposition 9.3.2 it suffices to find a continuous mapping ϕ of $\prod_{i=1}^{\infty}(A_i, \mathcal{T}_i)$ onto $[0, 1]$. Such a mapping is given by

$$\phi(\langle a_1, a_2, \dots, a_i, \dots \rangle) = \sum_{i=1}^{\infty} \frac{a_i}{2^{i+1}}.$$

Recalling that each $a_i \in \{0, 2\}$ and that each number $x \in [0, 1]$ has a dyadic expansion of the form $\sum_{j=1}^{\infty} \frac{b_j}{2^j}$, where $b_j \in \{0, 1\}$, we see that ϕ is an onto mapping. To show that ϕ is continuous it suffices, by Proposition 5.1.7, to verify that if U is the open interval

$$\left(\sum_{i=1}^{\infty} \frac{a_i}{2^{i+1}} - \varepsilon, \sum_{i=1}^{\infty} \frac{a_i}{2^{i+1}} + \varepsilon \right) \ni \sum_{i=1}^{\infty} \frac{a_i}{2^{i+1}}, \quad \text{for any } \varepsilon > 0.$$

then there exists an open set $W \ni \langle a_1, a_2, \dots, a_i, \dots \rangle$ such that $\phi(W) \subseteq U$. Choose N sufficiently large that $\sum_{i=N}^{\infty} \frac{a_i}{2^{i+1}} < \varepsilon$, and put

$$W = \{a_1\} \times \{a_2\} \times \dots \times \{a_N\} \times A_{N+1} \times A_{N+2} \times \dots$$

Then W is open in $\prod_{i=1}^{\infty}(A_i, \mathcal{T}_i)$, $W \ni \langle a_1, a_2, \dots, a_i, \dots \rangle$, and $\phi(W) \subseteq U$, as required. □

9.3.6 Remark. You should be somewhat surprised by Proposition 9.3.5 as it says that the “nice” space $[0, 1]$ is a continuous image of the very curious Cantor Space. However, we shall see in due course that every compact metric space is a continuous image of the Cantor Space. □

9.3.7 Definition. For each positive integer n , let the topological space (I_n, \mathcal{T}_n) be homeomorphic to $[0, 1]$. Then the product space $\prod_{n=1}^{\infty}(I_n, \mathcal{T}_n)$ is called the **Hilbert cube** and is denoted by I^{∞} . The product space $\prod_{i=1}^n(I_i, \mathcal{T}_i)$ is called the **n-cube** and is denoted by I^n , for each $n \in \mathbb{N}$.

We know from Tychonoff’s Theorem for finite products that I^n is compact for each n . We now prove that I^{∞} is compact. (Of course this result can also be deduced from Tychonoff’s Theorem for infinite products, which is proved in Chapter 10.)

9.3.8 Theorem. The Hilbert cube is compact.

Proof. By Proposition 9.3.5, there is a continuous mapping ϕ_n of (G_n, \mathcal{T}_n) onto (I_n, \mathcal{T}'_n) where, for each $n \in \mathbb{N}$, (G_n, \mathcal{T}_n) and (I_n, \mathcal{T}'_n) are homeomorphic to the Cantor Space and $[0,1]$, respectively. Therefore by Proposition 9.2.5 and Exercises 9.2 #2 (b), there is a continuous mapping ψ of $\prod_{n=1}^{\infty} (G_n, \mathcal{T}_n)$ onto $\prod_{n=1}^{\infty} (I_n, \mathcal{T}'_n) = I^{\infty}$. But Proposition 9.3.3 says that $\prod_{n=1}^{\infty} (G_n, \mathcal{T}_n)$ is homeomorphic to the Cantor Space (G, \mathcal{T}) . Therefore I^{∞} is a continuous image of the compact space (G, \mathcal{T}) , and hence is compact. \square

9.3.9 Proposition. Let (X_i, \mathcal{T}_i) , $i \in \mathbb{N}$, be a countably infinite family of metrizable spaces. Then $\prod_{i=1}^{\infty} (X_i, \mathcal{T}_i)$ is metrizable.

Proof. For each $i \in \mathbb{N}$, let d_i be a metric on X_i which induces the topology \mathcal{T}_i . Exercises 6.1 #2 says that if we put $e_i(a, b) = \min(1, d(a, b))$, for all a and b in X_1 , then e_i is a metric and it induces the topology \mathcal{T}_i on X_i . So we can, without loss of generality, assume that $d_i(a, b) \leq 1$, for all a and b in X_i , $i \in \mathbb{N}$.

Define $d: \prod_{i=1}^{\infty} X_i \times \prod_{i=1}^{\infty} X_i \rightarrow \mathbb{R}$ by

$$d\left(\prod_{i=1}^{\infty} a_i, \prod_{i=1}^{\infty} b_i\right) = \sum_{i=1}^{\infty} \frac{d_i(a_i, b_i)}{2^i} \text{ for all } a_i \text{ and } b_i \text{ in } X_i.$$

Observe that the series on the right hand side converges because each $d_i(a_i, b_i) \leq 1$ and so it is bounded above by $\sum_{i=1}^{\infty} \frac{1}{2^i} = 1$.

It is easily verified that d is a metric on $\prod_{i=1}^{\infty} X_i$. Observe that d'_i , defined by $d'_i(a, b) = \frac{d_i(a, b)}{2^i}$, is a metric on X_i , which induces the same topology \mathcal{T}_i as d_i . We claim that d induces the product topology on $\prod_{i=1}^{\infty} X_i$.

To see this consider the following. Since

$$d\left(\prod_{i=1}^{\infty} a_i, \prod_{i=1}^{\infty} b_i\right) \geq \frac{d_i(a_i, b_i)}{2^i} = d'_i(a_i, b_i)$$

it follows that the projection $p_i: (\prod_{i=1}^{\infty} X_i, d) \rightarrow (X_i, d'_i)$ is continuous, for each i . As d'_i induces the topology \mathcal{T}'_i , Proposition 9.2.4 (ii) implies that the topology induced on $\prod_{i=1}^{\infty} X_i$ by d is finer than the product topology.

To prove that the topology induced by d is also coarser than the product topology, let $B_{\varepsilon}(a)$ be any open ball of radius $\varepsilon > 0$ about a point $a = \prod_{i=1}^{\infty} a_i$. So $B_{\varepsilon}(a)$ is a basic open set in the topology induced by d . We have to show that there is a set $W \ni a$ such that $W \subseteq B_{\varepsilon}(a)$, and W is open in the product topology. Let N be a positive integer such that $\sum_{i=N}^{\infty} \frac{1}{2^i} < \frac{\varepsilon}{2}$. Let O_i be the open ball in (X_i, d_i) of radius $\frac{\varepsilon}{2N}$ about the point a_i , $i = 1, \dots, N$. Define

$$W = O_1 \times O_2 \times \cdots \times O_N \times X_{N+1} \times X_{N+2} \times \cdots$$

Then W is an open set in the product topology, $a \in W$, and clearly $W \subseteq B_{\varepsilon}(a)$, as required. \square

9.3.10 Corollary. The Hilbert Cube is metrizable. □

The proof of Proposition 9.3.9 can be refined to obtain the following result:

9.3.11 Proposition. Let (X_i, \mathcal{T}_i) , $i \in \mathbb{N}$, be a countably infinite family of completely metrizable spaces. Then $\prod_{i=1}^{\infty} (X_i, \mathcal{T}_i)$ is completely metrizable.

Proof. Exercises 9.3 #10. □

9.3.12 Remark. From Proposition 9.3.11 we see that a countably infinite product of discrete spaces is completely metrizable. The most interesting example of this is $\mathbb{N}^{\mathbb{N}}$, that is a countably infinite product of topological spaces each homeomorphic to the discrete space \mathbb{N} . What is much more surprising is the fact, as mentioned in Chapter 6, that \mathbb{N}^{∞} is homeomorphic to \mathbb{P} , the topological space of all irrational numbers with the euclidean topology. See Engelking [77] Exercise 4.3.G and Exercise 6.2.A.

9.3.13 Remark. Another important example of a completely metrizable countable product is \mathbb{R}^{∞} . This is the countably infinite product of topological spaces each homeomorphic to \mathbb{R} . Corollary 4.3.25 of Engelking [77] shows that: **a separable metrizable space is completely metrizable if and only if it is homeomorphic to a closed subspace of \mathbb{R}^{∞} .** In particular we see that every separable Banach space is homeomorphic to a closed subspace of \mathbb{R}^{∞} .

A beautiful and deep result says that: **every separable infinite-dimensional Banach space is homeomorphic to \mathbb{R}^{∞} ,** see Bessaga and Pelczynski [24].

Exercises 9.3

1. Let (X_i, d_i) , $i \in \mathbb{N}$, be a countably infinite family of metric spaces with the property that, for each i , $d_i(a, b) \leq 1$, for all a and b in X_i . Define $e : \prod_{i=1}^{\infty} X_i \times \prod_{i=1}^{\infty} X_i \rightarrow \mathbb{R}$ by

$$e \left(\prod_{i=1}^{\infty} a_i, \prod_{i=1}^{\infty} b_i \right) = \sup \{ d_i(a_i, b_i) : i \in \mathbb{N} \}.$$

Prove that e is a metric on $\prod_{i=1}^{\infty} X_i$ and is equivalent to the metric d in Proposition 9.3.9. (Recall that “equivalent” means “induces the same topology”.)

2. If (X_i, \mathcal{T}_i) , $i \in \mathbb{N}$, are compact subspaces of $[0, 1]$, deduce from Theorem 9.3.8 and Exercises 9.2 #1, that $\prod_{i=1}^{\infty} (X_i, \mathcal{T}_i)$ is compact.
3. Let $\prod_{i=1}^{\infty} (X_i, \mathcal{T}_i)$ be the product of a countable infinite family of topological spaces. Let (Y, \mathcal{T}) be a topological space and f a mapping of (Y, \mathcal{T}) into $\prod_{i=1}^{\infty} (X_i, \mathcal{T}_i)$. Prove that f is continuous if and only if each mapping $p_i \circ f: (Y, \mathcal{T}) \rightarrow (X_i, \mathcal{T}_i)$ is continuous, where p_i denotes the projection mapping.
4. (a) Let X be a finite set and \mathcal{T} a Hausdorff topology on X . Prove that
 - (i) \mathcal{T} is the discrete topology;
 - (ii) (X, \mathcal{T}) is homeomorphic to a subspace of $[0, 1]$.
 (b) Using (a) and Exercise 3 above, prove that if (X_i, \mathcal{T}_i) is a finite Hausdorff space for $i \in \mathbb{N}$, then $\prod_{i=1}^{\infty} (X_i, \mathcal{T}_i)$ is compact and metrizable.
 (c) Show that every finite topological space is a continuous image of a finite discrete space.
 (d) Using (b) and (c), prove that if (X_i, \mathcal{T}_i) is a finite topological space for each $i \in \mathbb{N}$, then $\prod_{i=1}^{\infty} (X_i, \mathcal{T}_i)$ is compact.
5. (i) Prove that the Sierpinski Space (Exercises 1.3 #5 (iii)) is a continuous image of $[0, 1]$.
 (ii) Using (i) and Proposition 9.2.5, show that if (X_i, \mathcal{T}_i) , for each $i \in \mathbb{N}$, is homeomorphic to the Sierpinski Space, then $\prod_{i=1}^{\infty} (X_i, \mathcal{T}_i)$ is compact.
6. (i) Let (X_i, \mathcal{T}_i) , $i \in \mathbb{N}$, be a countably infinite family of topological spaces each of which satisfies the second axiom of countability. Prove that $\prod_{i=1}^{\infty} (X_i, \mathcal{T}_i)$ satisfies the second axiom of countability.
 (ii) Using Exercises 3.2 #4 (viii) and Exercises 4.1 #14, deduce that the Hilbert cube and all of its subspaces are separable.
7. Let (X_i, \mathcal{T}_i) , $i \in \mathbb{N}$, be a countably infinite family of topological spaces. Prove that $\prod_{i=1}^{\infty} (X_i, \mathcal{T}_i)$ is a totally disconnected space if and only if each (X_i, \mathcal{T}_i) is totally disconnected. Deduce that the Cantor Space is totally disconnected.

8. Let (X, \mathcal{T}) be a topological space and $(X_{ij}, \mathcal{T}_{ij})$, $i \in \mathbb{N}$, $j \in \mathbb{N}$, a family of topological spaces each of which is homeomorphic to (X, \mathcal{T}) . Prove that

$$\prod_{j=1}^{\infty} \left(\prod_{i=1}^{\infty} (X_{ij}, \mathcal{T}_{ij}) \right) \cong \prod_{i=1}^{\infty} (X_{i1}, \mathcal{T}_{i1}).$$

[Hint: This result generalizes Proposition 9.3.3 and the proof uses a map analogous to ϕ .]

9. (i) Let (X_i, \mathcal{T}_i) , $i \in \mathbb{N}$, be a countably infinite family of topological spaces each of which is homeomorphic to the Hilbert cube. Deduce from Exercise 8 above that $\prod_{i=1}^{\infty} (X_i, \mathcal{T}_i)$ is homeomorphic to the Hilbert cube.
- (ii) Hence show that if (X_i, \mathcal{T}_i) , $i \in \mathbb{N}$, are compact subspaces of the Hilbert cube, then $\prod_{i=1}^{\infty} (X_i, \mathcal{T}_i)$ is compact.

10. Prove Proposition 9.3.11.

[Hint. In the notation of the proof of Proposition 9.3.9, show that if $a_n = \prod_{i=1}^{\infty} a_{in}$, $n \in \mathbb{N}$, is a Cauchy sequence in $(\prod_{i=1}^{\infty} X_i, d)$, then for each $i \in \mathbb{N}$, $\{a_{in} : n \in \mathbb{N}\}$ is a Cauchy sequence in X_i, d_i .]

9.4 Urysohn's Theorem

9.4.1 Definition. A topological space (X, \mathcal{T}) is said to be **separable** if it has a countable dense subset.

See Exercises 3.2 #4 and Exercises 8.1 #9 where separable spaces were introduced.

9.4.2 Example. \mathbb{Q} is dense in \mathbb{R} , and so \mathbb{R} is separable. □

9.4.3 Example. Every countable topological space is separable. □

9.4.4 Proposition. Let (X, \mathcal{T}) be a compact metrizable space. Then (X, \mathcal{T}) is separable.

Proof. Let d be a metric on X which induces the topology \mathcal{T} . For each positive integer n , let \mathcal{S}_n be the family of all open balls having centres in X and radius $\frac{1}{n}$. Then \mathcal{S}_n is an open covering of X and so there is a finite subcovering $\mathcal{U}_n = \{U_{n_1}, U_{n_2}, \dots, U_{n_k}\}$, for some $k \in \mathbb{N}$. Let y_{n_j} be the centre of U_{n_j} , $j = 1, \dots, k$, and $Y_n = \{y_{n_1}, y_{n_2}, \dots, y_{n_k}\}$. Put $Y = \bigcup_{n=1}^{\infty} Y_n$. Then Y is a countable subset of X . We now show that Y is dense in (X, \mathcal{T}) .

If V is any non-empty open set in (X, \mathcal{T}) , then for any $v \in V$, V contains an open ball, B , of radius $\frac{1}{n}$, about v , for some $n \in \mathbb{N}$. As \mathcal{U}_n is an open cover of X , $v \in U_{n_j}$, for some j . Thus $d(v, y_{n_j}) < \frac{1}{n}$ and so $y_{n_j} \in B \subseteq V$. Hence $V \cap Y \neq \emptyset$, and so Y is dense in X . \square

9.4.5 Corollary. The Hilbert cube is a separable space. \square

Shortly we shall prove the very striking Urysohn Theorem which shows that every compact metrizable space is homeomorphic to a subspace of the Hilbert cube. En route we prove the (countable version of the) Embedding Lemma.

First we record the following proposition, which is Exercises 9.3 #3 and so its proof is not included here.

9.4.6 Proposition. Let (X_i, \mathcal{T}_i) , $i \in \mathbb{N}$, be a countably infinite family of topological spaces and f a mapping of a topological space (Y, \mathcal{T}) into $\prod_{i=1}^{\infty} (X_i, \mathcal{T}_i)$. Then f is continuous if and only if each mapping $p_i \circ f: (Y, \mathcal{T}) \rightarrow (X_i, \mathcal{T}_i)$ is continuous, where p_i denotes the projection mapping of $\prod_{i=1}^{\infty} (X_i, \mathcal{T}_i)$ onto (X_i, \mathcal{T}_i) .

9.4.7 Lemma. (The Embedding Lemma) Let (Y_i, \mathcal{T}_i) , $i \in \mathbb{N}$, be a countably infinite family of topological spaces and for each i , let f_i be a mapping of a topological space (X, \mathcal{T}) into (Y_i, \mathcal{T}_i) . Further, let $e: (X, \mathcal{T}) \rightarrow \prod_{i=1}^{\infty} (Y_i, \mathcal{T}_i)$ be the **evaluation map**; that is, $e(x) = \prod_{i=1}^{\infty} f_i(x)$, for all $x \in X$. Then e is a homeomorphism of (X, \mathcal{T}) onto the space $(e(X), \mathcal{T}')$, where \mathcal{T}' is the subspace topology on $e(X)$, if

- (i) each f_i is continuous,
- (ii) the family $\{f_i : i \in \mathbb{N}\}$ **separates points** of X ; that is, if x_1 and x_2 are in X with $x_1 \neq x_2$, then for some i , $f_i(x_1) \neq f_i(x_2)$, and
- (iii) the family $\{f_i : i \in \mathbb{N}\}$ **separates points and closed sets**; that is, for $x \in X$ and A any closed subset of (X, \mathcal{T}) not containing x , $f_i(x) \notin \overline{f_i(A)}$, for some i .

Proof. That the mapping $e: (X, \mathcal{T}) \rightarrow (e(X), \mathcal{T}')$ is onto is obvious, while condition (ii) clearly implies that it is one-to-one.

As $p_i \circ e = f_i$ is a continuous mapping of (X, \mathcal{T}) into (Y_i, \mathcal{T}_i) , for each i , Proposition 9.4.6 implies that the mapping $e: (X, \mathcal{T}) \rightarrow \prod_{i=1}^{\infty} (Y_i, \mathcal{T}_i)$ is continuous. Hence $e: (X, \mathcal{T}) \rightarrow (e(X), \mathcal{T}')$ is continuous.

To prove that $e: (X, \mathcal{T}) \rightarrow (e(X), \mathcal{T}')$ is an open mapping, it suffices to verify that for each $U \in \mathcal{T}$ and $x \in U$, there exists a set $W \in \mathcal{T}'$ such that $e(x) \in W \subseteq e(U)$. As the family f_i , $i \in \mathbb{N}$, separates points and closed sets, there exists a $j \in \mathbb{N}$ such that $f_j(x) \notin \overline{f_j(X \setminus U)}$. Put

$$W = (Y_1 \times Y_2 \times \cdots \times Y_{j-1} \times [Y_j \setminus \overline{f_j(X \setminus U)}] \times Y_{j+1} \times Y_{j+2} \times \cdots) \cap e(X).$$

Then clearly $e(x) \in W$ and $W \in \mathcal{T}'$. It remains to show that $W \subseteq e(U)$. So let $e(t) \in W$. Then

$$\begin{aligned} f_j(t) &\in Y_j \setminus \overline{f_j(X \setminus U)} \\ \Rightarrow f_j(t) &\notin \overline{f_j(X \setminus U)} \\ \Rightarrow f_j(t) &\notin f_j(X \setminus U) \\ \Rightarrow t &\notin X \setminus U \\ \Rightarrow t &\in U. \end{aligned}$$

So $e(t) \in e(U)$ and hence $W \subseteq e(U)$. Therefore e is a homeomorphism. \square

9.4.8 Definition. A topological space (X, \mathcal{T}) is said to be a T_1 -space if every singleton set $\{x\}$, $x \in X$, is a closed set.

9.4.9 Remark. It is easily verified that every Hausdorff space (i.e. T_2 -space) is a T_1 -space. The converse, however, is false. (See Exercises 4.1 #13 and Exercises 1.3 #3.) In particular, every metrizable space is a T_1 -space.

9.4.10 Corollary. If (X, \mathcal{T}) in Lemma 9.4.7 is a T_1 -space, then condition (ii) is implied by condition (iii) (and so is superfluous).

Proof. Let x_1 and x_2 be any distinct points in X . Putting A equal to the closed set $\{x_2\}$, condition (iii) implies that for some i , $f_i(x_1) \notin \overline{\{f_i(x_2)\}}$. Hence $f_i(x_1) \neq f_i(x_2)$, and condition (ii) is satisfied. \square

9.4.11 Theorem. (Urysohn's Theorem) Every separable metric space (X, d) is homeomorphic to a subspace of the Hilbert cube.

Proof. By Corollary 9.4.10 this result will follow if we can find a countably infinite family of mappings $f_i: (X, d) \rightarrow [0, 1]$, which are (i) continuous, and (ii) separate points and closed sets.

Without loss of generality we can assume that $d(a, b) \leq 1$, for all a and b in X , since every metric is equivalent to such a metric.

As (X, d) is separable, there exists a countable dense subset $Y = \{y_i, i \in \mathbb{N}\}$. For each $i \in \mathbb{N}$, define $f_i: X \rightarrow [0, 1]$ by $f_i(x) = d(x, y_i)$. It is clear that each mapping f_i is continuous.

To see that the mappings $\{f_i : i \in \mathbb{N}\}$ separate points and closed sets, let $x \in X$ and A be any closed set not containing x . Now $X \setminus A$ is an open set about x and so contains an open ball B of radius ε and centre x , for some $\varepsilon > 0$.

Further, as Y is dense in X , there exists a y_n such that $d(x, y_n) < \frac{\varepsilon}{2}$. Thus $d(y_n, a) \geq \frac{\varepsilon}{2}$, for all $a \in A$.

So $[0, \frac{\varepsilon}{2})$ is an open set in $[0, 1]$ which contains $f_n(x)$, but $f_n(a) \notin [0, \frac{\varepsilon}{2})$, for all $a \in A$. This implies $f_n(A) \subseteq [\frac{\varepsilon}{2}, 1]$. As the set $[\frac{\varepsilon}{2}, 1]$ is closed, this implies $\overline{f_n(A)} \subseteq [\frac{\varepsilon}{2}, 1]$.

Hence $f_n(x) \notin \overline{f_n(A)}$ and thus the family $\{f_i : i \in \mathbb{N}\}$ separates points and closed sets. \square

9.4.12 Corollary. Every compact metrizable space is homeomorphic to a closed subspace of the Hilbert cube. \square

9.4.13 Corollary. If for each $i \in \mathbb{N}$, (X_i, \mathcal{T}_i) is a compact metrizable space, then $\prod_{i=1}^{\infty} (X_i, \mathcal{T}_i)$ is compact and metrizable.

Proof. That $\prod_{i=1}^{\infty} (X_i, \mathcal{T}_i)$ is metrizable was proved in Proposition 9.3.9. That $\prod_{i=1}^{\infty} (X_i, \mathcal{T}_i)$ is compact follows from Corollary 9.4.12 and Exercises 9.3 #9 (ii). \square

Our next task is to verify the converse of Urysohn's Theorem. To do this we introduce a new concept. (See Exercises 2.2 #4.)

9.4.14 Definition. A topological space (X, \mathcal{T}) is said to satisfy the **second axiom of countability** (or to be **second countable**) if there exists a basis \mathcal{B} for \mathcal{T} such that \mathcal{B} consists of only a countable number of sets.

9.4.15 Example. Let $\mathcal{B} = \{(q - \frac{1}{n}, q + \frac{1}{n}) : q \in \mathbb{Q}, n \in \mathbb{N}\}$. Then \mathcal{B} is a basis for the euclidean topology on \mathbb{R} . (Verify this). Therefore \mathbb{R} is second countable. \square

9.4.16 Example. Let (X, \mathcal{T}) be an uncountable set with the discrete topology. Then, as every singleton set must be in any basis for \mathcal{T} , (X, \mathcal{T}) does not have any countable basis. So (X, \mathcal{T}) is not second countable. \square

9.4.17 Proposition. Let (X, d) be a metric space and \mathcal{T} the induced topology. Then (X, \mathcal{T}) is a separable space if and only if it satisfies the second axiom of countability.

Proof. Let (X, \mathcal{T}) be separable. Then it has a countable dense subset $Y = \{y_i : i \in \mathbb{N}\}$. Let \mathcal{B} consist of all the open balls (in the metric d) with centre y_i , for some i , and radius $\frac{1}{n}$, for some positive integer n . Clearly \mathcal{B} is countable and we shall show that it is a basis for \mathcal{T} .

Let $V \in \mathcal{T}$. Then for any $v \in V$, V contains an open ball, B , of radius $\frac{1}{n}$ about v , for some n . As Y is dense in X , there exists a $y_m \in Y$, such that $d(y_m, v) < \frac{1}{2n}$. Let B' be the open ball with centre y_m and radius $\frac{1}{2n}$. Then the triangle inequality implies $B' \subseteq B \subseteq V$. Also $B' \in \mathcal{B}$. Hence \mathcal{B} is a basis for \mathcal{T} . So (X, \mathcal{T}) is second countable.

Conversely let (X, \mathcal{T}) be second countable, having a countable basis $\mathcal{B}_1 = \{B_i : i \in \mathbb{N}\}$. For each $B_i \neq \emptyset$, let b_i be any element of B_i , and put Z equal to the set of all such b_i . Then Z is a countable set. Further, if $V \in \mathcal{T}$, then $V \supseteq B_i$, for some i , and so $b_i \in V$. Thus $V \cap Z \neq \emptyset$. Hence Z is dense in X . Consequently (X, \mathcal{T}) is separable. \square

9.4.18 Remark. The above proof shows that **every second countable space is separable**, even without the assumption of metrizability. However, it is **not** true, in general, that a separable space is second countable. (See Exercises 9.4 #11.)

9.4.19 Theorem. (Urysohn's Theorem and its Converse) Let (X, \mathcal{T}) be a topological space. Then (X, \mathcal{T}) is separable and metrizable if and only if it is homeomorphic to a subspace of the Hilbert cube.

Proof. If (X, \mathcal{T}) is separable and metrizable, then Urysohn's Theorem 9.4.11 says that it is homeomorphic to a subspace of the Hilbert cube.

Conversely, let (X, \mathcal{T}) be homeomorphic to the subspace (Y, \mathcal{T}_1) of the Hilbert cube I^∞ . By Proposition 9.4.4, I^∞ is separable. So, by Proposition 9.4.17, it is second countable. It is readily verified (Exercises 4.1 #14) that any subspace of a second countable space is second countable, and hence (Y, \mathcal{T}_1) is second countable. It is also easily verified (Exercises 6.1 #6) that any subspace of a metrizable space is metrizable. As the Hilbert cube is metrizable, by Corollary 9.3.10, its subspace (Y, \mathcal{T}_1) is metrizable. So (Y, \mathcal{T}_1) is metrizable and satisfies the second axiom of countability. Therefore it is separable. Hence (X, \mathcal{T}) is also separable and metrizable. \square

Exercises 9.4

1. Prove that every continuous image of a separable space is separable.
2. If (X_i, \mathcal{T}_i) , $i \in \mathbb{N}$, are separable spaces, prove that $\prod_{i=1}^{\infty} (X_i, \mathcal{T}_i)$ is a separable space.
3. If all the spaces (Y_i, \mathcal{T}_i) in Lemma 9.4.7 are Hausdorff and (X, \mathcal{T}) is compact, show that condition (iii) of the lemma is superfluous.
4. If (X, \mathcal{T}) is a countable discrete space, prove that it is homeomorphic to a subspace of the Hilbert cube.
5. Verify that $C[0, 1]$, with the metric d described in Example 6.1.5, is homeomorphic to a subspace of the Hilbert cube.
6. If (X_i, \mathcal{T}_i) , $i \in \mathbb{N}$, are second countable spaces, prove that $\prod_{i=1}^{\infty} (X_i, \mathcal{T}_i)$ is second countable.
7. **(Lindelöf's Theorem)** Prove that every open covering of a second countable space has a countable subcovering.

8. Deduce from Theorem 9.4.19 that every subspace of a separable metrizable space is separable and metrizable.
9. (i) Prove that the set of all isolated points of a second countable space is countable.
- (ii) Hence, show that any uncountable subset A of a second countable space contains at least one point which is a limit point of A .
10. (i) Let f be a continuous mapping of a Hausdorff non-separable space (X, \mathcal{T}) onto itself. Prove that there exists a proper non-empty closed subset A of X such that $f(A) = A$. [Hint: Let $x_0 \in X$ and define a set $S = \{x_n : n \in \mathbb{Z}\}$ such that $x_{n+1} = f(x_n)$ for every integer n .]
- (ii) Is the above result true if (X, \mathcal{T}) is separable? (Justify your answer.)
11. Let \mathcal{T} be the topology defined on \mathbb{R} in Example 2.3.1. Prove that
- (i) $(\mathbb{R}, \mathcal{T})$ is separable;
- (ii) $(\mathbb{R}, \mathcal{T})$ is not second countable.
12. A topological space (X, \mathcal{T}) is said to satisfy the **countable chain condition** if every disjoint family of open sets is countable.
- (i) Prove that every separable space satisfies the countable chain condition.
- (ii) Let X be an uncountable set and \mathcal{T} the countable-closed topology on X . Show that (X, \mathcal{T}) satisfies the countable chain condition but is not separable.

13. A topological space (X, \mathcal{T}) is said to be **scattered** if every non-empty subspace of X has an isolated point (see Exercises 9.1 #2).
- (i) Verify that \mathbb{R} , \mathbb{Q} , and the Cantor Space are not scattered, while every discrete space is scattered.
 - (ii) Let $X = \mathbb{R}^2$, d the Euclidean metric on \mathbb{R}^2 and d' the metric on X given by $d'(x, y) = d(x, 0) + d(0, y)$ if $x \neq y$ and $d'(x, y) = 0$ if $x = y$. Let \mathcal{T} be the topology induced on X by the metric d' . The metric d' is called the **Post Office Metric**. A topological space is said to be **extremally disconnected** if the closure of every open set is open. A topological space (Y, \mathcal{T}_1) is said to be **collectionwise Hausdorff** if for every discrete subspace (Z, \mathcal{T}_2) of (Y, \mathcal{T}_1) and each pair of points z_1, z_2 in Z , there are disjoint open sets U_1, U_2 in (Y, \mathcal{T}_1) such that $z_1 \in U_1$ and $z_2 \in U_2$. Prove the following:
 - (a) Every point in (X, \mathcal{T}) , except $x = 0$, is an isolated point.
 - (b) 0 is not an isolated point of (X, \mathcal{T}) .
 - (c) (X, \mathcal{T}) is a scattered space.
 - (d) (X, \mathcal{T}) is totally disconnected.
 - (e) (X, \mathcal{T}) is not compact.
 - (f) (X, \mathcal{T}) is not locally compact (see Exercise 8.3 #1).
 - (g) Every separable metric space has cardinality less than or equal to \mathfrak{c} .
 - (h) (X, \mathcal{T}) is an example of a metrizable space of cardinality \mathfrak{c} which is not separable. (Note that the metric space (ℓ_∞, d_∞) of Exercises 6.1 #7 (iii) is also of cardinality \mathfrak{c} and not separable.)
 - (i) Every discrete space is extremally disconnected.
 - (j) (X, \mathcal{T}) is not extremally disconnected.
 - (k) The product of any two scattered spaces is a scattered space.
 - (l) Let (S, \mathcal{T}_3) be the subspace $\{0, 1, \frac{1}{2}, \frac{1}{3}, \dots, \frac{1}{n}, \dots\}$ of \mathbb{R} . Then S is not extremally disconnected.
 - (m)* Every extremally disconnected metrizable space is discrete.
[Hint. Show that every convergent sequence must have repeated terms.]
 - (n) A topological space is Hausdorff if and only if it is a T_1 -space and collectionwise Hausdorff.
 - (o)* Every extremally disconnected collectionwise Hausdorff space is discrete.

9.5 Peano's Theorem

9.5.1 Remark. In the proof of Theorem 9.3.8 we showed that the Hilbert cube I^∞ is a continuous image of the Cantor Space (G, \mathcal{T}) . In fact, every compact metric space is a continuous image of the Cantor Space. The next proposition is a step in this direction.

9.5.2 Proposition. Every separable metrizable space (X, \mathcal{T}_1) is a continuous image of a subspace of the Cantor Space (G, \mathcal{T}) . Further, if (X, \mathcal{T}_1) is compact, then the subspace can be chosen to be closed in (G, \mathcal{T}) .

Proof. Let ϕ be the continuous mapping of (G, \mathcal{T}) onto I^∞ shown to exist in the proof of Theorem 9.3.8. By Urysohn's Theorem, (X, \mathcal{T}_1) is homeomorphic to a subspace (Y, \mathcal{T}_2) of I^∞ . Let the homeomorphism of (Y, \mathcal{T}_2) onto (X, \mathcal{T}_1) be Θ . Let $Z = \psi^{-1}(Y)$ and \mathcal{T}_3 be the subspace topology on Z . Then $\Theta \circ \psi$ is a continuous mapping of (Z, \mathcal{T}_3) onto (X, \mathcal{T}_1) . So (X, \mathcal{T}_1) is a continuous image of the subspace (Z, \mathcal{T}_3) of (G, \mathcal{T}) .

Further if (X, \mathcal{T}_1) is compact, then (Y, \mathcal{T}_2) is compact and hence closed in I^∞ . So $Z = \psi^{-1}(Y)$ is a closed subset of (G, \mathcal{T}) , as required. □

9.5.3 Proposition. Let (Y, \mathcal{T}_1) be a (non-empty) closed subspace of the Cantor Space (G, \mathcal{T}) . Then there exists a continuous mapping of (G, \mathcal{T}) onto (Y, \mathcal{T}_1) .

Proof. Let (G', \mathcal{T}') be the set of all real numbers which can be written in the form $\sum_{i=1}^{\infty} \frac{a_i}{6^i}$, where each $a_i = 0$ or 5 , with the subspace topology induced from \mathbb{R} . The space (G', \mathcal{T}') is called the **middle two-thirds Cantor Space**. Clearly (G', \mathcal{T}') is homeomorphic to the Cantor Space (G, \mathcal{T}) .

We can regard (Y, \mathcal{T}_1) as a closed subspace of (G', \mathcal{T}') and seek a continuous mapping of (G', \mathcal{T}') onto (Y, \mathcal{T}_1) . Before proceeding, observe from the construction of the middle two thirds Cantor space that if $g_1 \in G'$ and $g_2 \in G'$, then $\frac{g_1+g_2}{2} \notin G'$.

The map $\psi : (G', \mathcal{T}')$ \longrightarrow (Y, \mathcal{T}_1) which we seek is defined as follows: for $g \in G'$, $\psi(g)$ is the unique element of Y which is closest to g in the euclidean metric on \mathbb{R} . However we have to prove that such a unique closest element exists.

Fix $g \in G'$. Then the map $d_g : (Y, \mathcal{T}_1) \longrightarrow \mathbb{R}$ given by $d_g(y) = |g - y|$ is continuous. As (Y, \mathcal{T}_1) is compact, Proposition 7.2.15 implies that $d_g(Y)$ has a least element. So there exists an element of (Y, \mathcal{T}_1) which is closest to g . Suppose there are two such elements y_1 and y_2 in Y which are equally close to g . Then $g = \frac{y_1+y_2}{2}$. But $y_1 \in G'$ and $y_2 \in G'$ and so, as observed above, $g = \frac{y_1+y_2}{2} \notin G'$, which is a contradiction. So there exists a unique element of Y which is closest to g . Call this element $\psi(g)$.

It is clear that the map $\psi : (G', \mathcal{T}')$ \longrightarrow (Y, \mathcal{T}_1) is surjective, since for each $y \in Y$, $\psi(y) = y$. To prove continuity of ψ , let $g \in G'$. Let ε be any given positive real number. Then it suffices, by Corollary 6.2.4, to find a $\delta > 0$, such that if $x \in G'$ and $|g - x| < \delta$ then $|\psi(g) - \psi(x)| < \varepsilon$.

Consider firstly the case when $g \in Y$, so $\psi(g) = g$. Put $\delta = \frac{\varepsilon}{2}$. Then for $x \in G'$ with $|g - x| < \delta$ we have

$$\begin{aligned} |\psi(g) - \psi(x)| &= |g - \psi(x)| \\ &\leq |x - \psi(x)| + |g - x| \\ &\leq |x - g| + |g - x|, \text{ by definition of } \psi \text{ since } g \in Y \\ &= 2|x - g| \\ &< 2\delta \\ &= \varepsilon, \text{ as required.} \end{aligned}$$

Now consider the case when $g \notin Y$, so $g \neq \psi(g)$.

Without loss of generality, assume $\psi(g) < g$ and put $a = g - \psi(g)$.

If the set $Y \cap [g, 1] = \emptyset$, then $\psi(x) = \psi(g)$ for all $x \in (g - \frac{a}{2}, g + \frac{a}{2})$.

Thus for $\delta < \frac{a}{2}$, we have $|\psi(x) - \psi(g)| = 0 < \varepsilon$, as required.

If $Y \cap [g, 1] \neq \emptyset$, then as $Y \cap [g, 1]$ is compact it has a least element $y > g$.

Indeed by the definition of ψ , if $b = y - g$, then $b > a$.

Now put $\delta = \frac{b-a}{2}$.

So if $x \in G'$ with $|g - x| < \delta$, then either $\psi(x) = \psi(g)$ or $\psi(x) = y$. Observe that

$$|x - \psi(g)| \leq |x - g| + |g - \psi(g)| < \delta + a = \frac{b-a}{2} + a = \frac{b}{2} + \frac{a}{2}$$

while

$$|x - y| \geq |g - y| - |g - x| \geq b - \frac{b-a}{2} = \frac{b}{2} + \frac{a}{2}.$$

So $\psi(x) = \psi(g)$.

Thus $|\psi(x) - \psi(g)| = 0 < \varepsilon$, as required. Hence ψ is continuous. \square

Thus we obtain from Propositions 9.5.2 and 9.5.3 the following theorem of Alexandroff and Urysohn:

9.5.4 Theorem. Every compact metrizable space is a continuous image of the Cantor Space. \square

9.5.5 Remark. The converse of Theorem 9.5.4 is false. It is not true that every continuous image of a Cantor Space is a compact metrizable space. (Find an example.) However, an analogous statement is true if we look only at Hausdorff spaces. Indeed we have the following proposition.

9.5.6 Proposition. Let f be a continuous mapping of a compact metric space (X, d) onto a Hausdorff space (Y, \mathcal{T}_1) . Then (Y, \mathcal{T}_1) is compact and metrizable.

Proof. Since every continuous image of a compact space is compact, the space (Y, \mathcal{T}_1) is certainly compact. As the map f is surjective, we can define a metric d_1 on Y as follows:

$$d_1(y_1, y_2) = \inf\{d(a, b) : a \in f^{-1}\{y_1\} \text{ and } b \in f^{-1}\{y_2\}\}, \text{ for all } y_1 \text{ and } y_2 \text{ in } Y.$$

We need to show that d_1 is indeed a metric. Since $\{y_1\}$ and $\{y_2\}$ are closed in the Hausdorff space (Y, \mathcal{T}_1) , $f^{-1}\{y_1\}$ and $f^{-1}\{y_2\}$ are closed in the compact space (X, d) . Hence the sets $f^{-1}\{y_1\}$ and $f^{-1}\{y_2\}$ are compact. So the product $f^{-1}\{y_1\} \times f^{-1}\{y_2\}$, which is a subspace of the product space $(X, \mathcal{T}) \times (X, \mathcal{T})$, is compact, where \mathcal{T} is the topology induced by the metric d .

Observing that $d: (X, \mathcal{T}) \times (X, \mathcal{T}) \rightarrow \mathbb{R}$ is a continuous mapping, Proposition 7.2.15 implies that $d(f^{-1}\{y_1\} \times f^{-1}\{y_2\})$, has a least element.

So there exists an element $x_1 \in f^{-1}\{y_1\}$ and an element $x_2 \in f^{-1}\{y_2\}$ such that

$$d(x_1, x_2) = \inf\{d(a, b) : a \in f^{-1}\{y_1\}, b \in f^{-1}\{y_2\}\} = d_1(y_1, y_2).$$

Clearly if $y_1 \neq y_2$, then $f^{-1}\{y_1\} \cap f^{-1}\{y_2\} = \emptyset$. Thus $x_1 \neq x_2$ and hence $d(x_1, x_2) > 0$; that is, $d_1(y_1, y_2) > 0$.

It is easily verified that d_1 has the other properties required of a metric, and so is a metric on Y .

Let \mathcal{T}_2 be the topology induced on Y by d_1 . We have to show that $\mathcal{T}_1 = \mathcal{T}_2$.

Firstly, by the definition of d_1 , $f: (X, \mathcal{T}) \rightarrow (Y, \mathcal{T}_2)$ is certainly continuous.

Observe that for a subset C of Y ,

$$\begin{aligned} & C \text{ is a closed subset of } (Y, \mathcal{T}_1) \\ \Rightarrow & f^{-1}(C) \text{ is a closed subset of } (X, \mathcal{T}) \\ \Rightarrow & f^{-1}(C) \text{ is a compact subset of } (X, \mathcal{T}) \\ \Rightarrow & f(f^{-1}(C)) \text{ is a compact subset of } (Y, \mathcal{T}_2) \\ \Rightarrow & C \text{ is a compact subset of } (Y, \mathcal{T}_2) \\ \Rightarrow & C \text{ is closed in } (Y, \mathcal{T}_2). \end{aligned}$$

So $\mathcal{T}_1 \subseteq \mathcal{T}_2$. Similarly we can prove $\mathcal{T}_2 \subseteq \mathcal{T}_1$, and thus $\mathcal{T}_1 = \mathcal{T}_2$. □

9.5.7 Corollary. Let (X, \mathcal{T}) be a Hausdorff space. Then it is a continuous image of the Cantor Space if and only if it is compact and metrizable. \square

Finally in this chapter we turn to space-filling curves.

9.5.8 Remark. Everyone thinks he or she knows what a “curve” is. Formally we can define a curve in \mathbb{R}^2 to be the set $f[0, 1]$, where f is a continuous map $f : [0, 1] \rightarrow \mathbb{R}^2$. It seems intuitively clear that a curve has no breadth and hence zero area. This is false! In fact there exist space-filling curves; that is, $f(I)$ has non-zero area. Indeed the next theorem shows that there exists a continuous mapping of $[0, 1]$ onto the product space $[0, 1] \times [0, 1]$.

9.5.9 Theorem. (Peano) For each positive integer n , there exists a continuous mapping ψ_n of $[0, 1]$ onto the n -cube I^n .

Proof. By Theorem 9.5.4, there exists a continuous mapping ϕ_n of the Cantor Space (G, \mathcal{T}) onto the n -cube I^n . As (G, \mathcal{T}) is obtained from $[0, 1]$ by successively dropping out middle thirds, we extend ϕ_n to a continuous mapping $\psi_n : [0, 1] \rightarrow I^n$ by defining ψ_n to be linear on each omitted interval; that is, if (a, b) is one of the open intervals comprising $[0, 1] \setminus G$, then ψ_n is defined on (a, b) by

$$\psi_n(\alpha a + (1 - \alpha)b) = \alpha \phi_n(a) + (1 - \alpha) \phi_n(b), \quad 0 \leq \alpha \leq 1.$$

It is easily verified that ψ_n is continuous. \square

We conclude this chapter by stating (but not proving) the Hahn-Mazurkiewicz Theorem which characterizes those Hausdorff spaces which are continuous images of $[0, 1]$. [For a proof of the theorem see Wilder [223] and p. 221 of Kuratowski [140].] But first we need a definition.

9.5.10 Definition. A topological space (X, \mathcal{T}) is said to be **locally connected** if it has a basis of connected (open) sets.

9.5.11 Remark. Every discrete space is locally connected as are \mathbb{R}^n and \mathbb{S}^n , for all $n \geq 1$. However, not every connected space is locally connected. (See Exercises 8.4 #6.)

9.5.12 Theorem. (Hahn-Mazurkiewicz Theorem) Let (X, \mathcal{T}) be a Hausdorff space. Then (X, \mathcal{T}) is a continuous image of $[0, 1]$ if and only if it is compact, connected, metrizable and locally connected.

Exercises 9.5

1. Let $S \subset \mathbb{R}^2$ be the set of points inside and on the triangle ABC , which has a right angle at A and satisfies $AC > AB$. This exercise outlines the construction of a continuous surjection $f : [0, 1] \rightarrow S$.

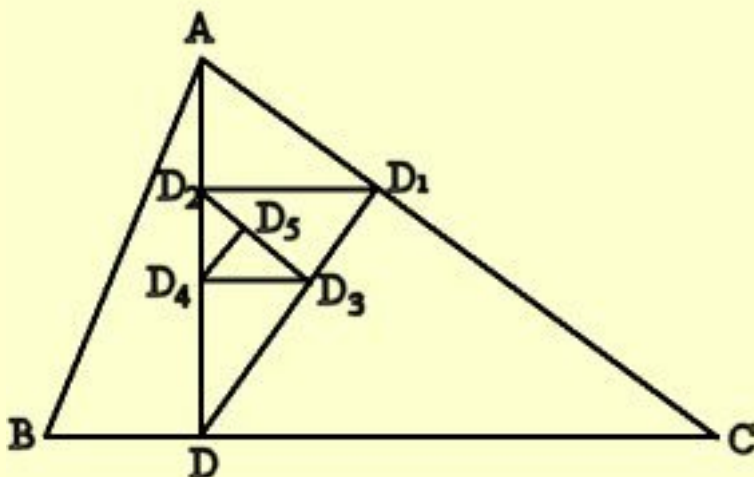

Let D on BC be such that AD is perpendicular to BC . Let $a = .a_1a_2a_3\dots$ be a binary decimal, so that each a_n is 0 or 1. Then we construct a sequence (D_n) of points of S as follows : D_1 is the foot of the perpendicular from D onto the hypotenuse of the larger or smaller of the triangles ADB, ADC according as $a_1 = 1$ or 0, respectively. This construction is now repeated using D_1 instead of D and the appropriate triangle of ADB, ADC instead of ABC . For example, the figure above illustrates the points D_1 to D_5 for the binary decimal $.1010\dots$. Give a rigorous inductive definition of the sequence (D_n) and prove

- (i) the sequence (D_n) tends to a limit $D(a)$ in S ;
- (ii) if $\lambda \in [0, 1]$ is represented by distinct binary decimals a, a' then $D(a) = D(a')$; hence, the point $D(\lambda)$ in S is uniquely defined;
- (iii) if $f : [0, 1] \rightarrow S$ is given by $f(\lambda) = D(\lambda)$ then f is surjective;
- (iv) f is continuous.

2. Let (G, \mathcal{T}) be the Cantor Space and consider the mappings

$$\phi_i : (G, \mathcal{T}) \rightarrow [0, 1], \quad i = 1, 2,$$

where

$$\phi_1 \left[\sum_{i=1}^{\infty} \frac{a_i}{3^i} \right] = \frac{a_1}{2^2} + \frac{a_3}{2^3} + \cdots + \frac{a_{2n-1}}{2^{n+1}} + \cdots$$

and

$$\phi_2 \left[\sum_{i=1}^{\infty} \frac{a_i}{3^i} \right] = \frac{a_2}{2^2} + \frac{a_4}{2^3} + \cdots + \frac{a_{2n}}{2^{n+1}} + \cdots$$

- (i) Prove that ϕ_1 and ϕ_2 are continuous.
(ii) Prove that the map $a \mapsto \langle \phi_1(a), \phi_2(a) \rangle$ is a continuous map of (G, \mathcal{T}) onto $[0, 1] \times [0, 1]$.
(iii) If a and $b \in (G, \mathcal{T})$ and $(a, b) \cap G = \emptyset$, define, for $j = 1, 2$,

$$\phi_j(x) = \frac{b-x}{b-a} \phi_j(a) + \frac{x-a}{b-a} \phi_j(b), \quad a \leq x \leq b.$$

Show that

$$x \mapsto \langle \phi_1(x), \phi_2(x) \rangle$$

is a continuous mapping of $[0, 1]$ onto $[0, 1] \times [0, 1]$ and that each point of $[0, 1] \times [0, 1]$ is the image of at most three points of $[0, 1]$.

9.6 Postscript

In this section we have extended the notion of a product of a finite number of topological spaces to that of the product of a countable number of topological spaces. While this step is a natural one, it has led us to a rich collection of results, some of which are very surprising.

We proved that a countable product of topological spaces with property \mathcal{P} has property \mathcal{P} , where \mathcal{P} is any of the following: (i) T_0 -space (ii) T_1 -space (iii) Hausdorff (iv) metrizable (v) connected (vi) totally disconnected (vii) second countable. It is also true when \mathcal{P} is compact, this result being the Tychonoff Theorem for countable products. The proof of the countable Tychonoff Theorem for metrizable spaces presented here is quite different from the standard one which appears in the next section. Our proof relies on the Cantor Space.

The Cantor Space was defined to be a certain subspace of $[0, 1]$. Later it was shown that it is homeomorphic to a countably infinite product of 2-point discrete spaces. The Cantor Space appears to be the kind of pathological example pure mathematicians are fond of producing in order to show that some general statement is false. But it turns out to be much more than this.

The Alexandroff-Urysohn Theorem says that every compact metrizable space is an image of the Cantor Space. In particular $[0, 1]$ and the Hilbert cube (a countable infinite product of copies of $[0, 1]$) is a continuous image of the Cantor Space. This leads us to the existence of space-filling curves – in particular, we show that there exists a continuous map of $[0, 1]$ onto the cube $[0, 1]^n$, for each positive integer n . We stated, but did not prove, the Hahn-Mazurkiewicz Theorem: The Hausdorff space (X, \mathcal{T}) is an image of $[0, 1]$ if and only if it is compact connected locally connected and metrizable.

Finally we mention Urysohn's Theorem, which says that a space is separable and metrizable if and only if it is homeomorphic to a subspace of the Hilbert cube. This shows that $[0, 1]$ is not just a "nice" topological space, but a "generator" of the important class of separable metrizable spaces via the formation of subspaces and countable products.

Chapter 10

Tychonoff's Theorem

Introduction

In Chapter 9 we defined the product of a countably infinite family of topological spaces. We now proceed to define the product of any family of topological spaces by replacing the set $\{1, 2, \dots, n, \dots\}$ by an arbitrary index set I . The central result will be the general Tychonoff Theorem.

10.1 The Product Topology For All Products

10.1.1 Definitions. Let I be a set, and for each $i \in I$, let (X_i, \mathcal{T}_i) be a topological space. We write the indexed family of topological spaces as $\{(X_i, \mathcal{T}_i) : i \in I\}$. Then the **product** (or **cartesian product**) of the family of sets $\{X_i : i \in I\}$ is denoted by $\prod_{i \in I} X_i$, and consists of the set of all functions $f: I \rightarrow \bigcup_{i \in I} X_i$ such that $f_i = x_i \in X_i$. We denote the element f of the product by $\prod_{i \in I} x_i$, and refer to $f(i) = x_i$ as the i^{th} coordinate.

If $I = \{1, 2\}$ then $\prod_{i \in \{1, 2\}} X_i$ is just the set of all functions $f: \{1, 2\} \rightarrow X_1 \cup X_2$ such that $f(1) \in X_1$ and $f(2) \in X_2$. A moment's thought shows that $\prod_{i \in \{1, 2\}} X_i$ is a set "isomorphic to" $X_1 \times X_2$. Similarly if $I = \{1, 2, \dots, n, \dots\}$, then $\prod_{i \in I} X_i$ is "isomorphic to" our previously defined $\prod_{i=1}^{\infty} X_i$.

The **product space**, denoted by $\prod_{i \in I} (X_i, \mathcal{T}_i)$, consists of the product set $\prod_{i \in I} X_i$ with the topology \mathcal{T} having as its basis the family

$$\mathcal{B} = \left\{ \prod_{i \in I} O_i : O_i \in \mathcal{T}_i \text{ and } O_i = X_i, \text{ for all but a finite number of } i \right\}.$$

The topology \mathcal{T} is called the **product topology** (or the **Tychonoff topology**).

10.1.2 Remark. Although we have defined $\prod_{i \in I} (X_i, \mathcal{T}_i)$ rather differently to the way we did when I was countably infinite or finite you should be able to convince yourself that when I is countably infinite or finite the new definition is equivalent to our previous ones. Once this is realized many results on countable products can be proved for uncountable products in an analogous fashion. We state them below. It is left as an exercise for the reader to prove these results for uncountable products.

10.1.3 Proposition. Let I be a set and for $i \in I$, let C_i be a closed subset of a topological space (X, \mathcal{T}_i) . Then $\prod_{i \in I} C_i$ is a closed subset of $\prod_{i \in I} (X_i, \mathcal{T}_i)$. \square

10.1.4 Proposition. Let I be a set and let $\{(X_i, \mathcal{T}_i) : i \in I\}$ be a family of topological spaces having product space $(\prod_{i \in I} X_i, \mathcal{T})$. If for each $i \in I$, B_i is a basis for \mathcal{T}_i , then

$$\mathcal{B}' = \left\{ \prod_{i \in I} O_i : O_i \in B_i \text{ and } O_i = X_i \text{ for all but a finite number of } i \right\}$$

is a basis for \mathcal{T} . □

10.1.5 Proposition. Let I be a set and let $\{(X_i, \mathcal{T}_i) : i \in I\}$ be a family of topological spaces having product space $(\prod_{i \in I} X_i, \mathcal{T})$. For each $j \in I$, let $p_j : \prod_{i \in I} X_i \rightarrow X_j$ be the projection mapping; that is, $p_j(\prod_{i \in I} x_i) = x_j$, for each $\prod_{i \in I} x_i \in \prod_{i \in I} X_i$. Then

(i) each p_j is a continuous surjective open mapping, and

(ii) \mathcal{T} is the coarsest topology on the set $\prod_{i \in I} X_i$ such that each p_j is continuous. □

10.1.6 Proposition. Let I be a set and let $\{(X_i, \mathcal{T}_i) : i \in I\}$ be a family of topological spaces with product space $\prod_{i \in I} (X_i, \mathcal{T}_i)$. Then each (X_i, \mathcal{T}_i) is homeomorphic to a subspace of $\prod_{i \in I} (X_i, \mathcal{T}_i)$. □

10.1.7 Proposition. Let I be a set and let $\{(X_i, \mathcal{T}_i) : i \in I\}$ and $\{(Y_i, \mathcal{T}'_i) : i \in I\}$ be families of topological spaces. If $h_i : (X_i, \mathcal{T}_i) \rightarrow (Y_i, \mathcal{T}'_i)$ is a continuous mapping, for each $i \in I$, then $h : \prod_{i \in I} (X_i, \mathcal{T}_i) \rightarrow \prod_{i \in I} (Y_i, \mathcal{T}'_i)$ is continuous, where $h(\prod_{i \in I} x_i) = \prod_{i \in I} h_i(x_i)$. □

10.1.8 Proposition. Let I be a set and let $\{(X_i, \mathcal{T}_i) : i \in I\}$ be a family of topological spaces and f a mapping of a topological space (Y, \mathcal{T}) into $\prod_{i \in I} (X_i, \mathcal{T}_i)$. Then f is continuous if and only if each mapping $p_i \circ f : (Y, \mathcal{T}) \rightarrow (X_i, \mathcal{T}_i)$ is continuous, where $p_i, i \in I$, denotes the projection mapping of $\prod_{i \in I} (X_i, \mathcal{T}_i)$ onto (X_i, \mathcal{T}_i) . □

10.1.9 Lemma. (The Embedding Lemma) Let I be an index set and $\{(Y_i, \mathcal{T}_i) : i \in I\}$ a family of topological spaces and for each $i \in I$, let f_i be a mapping of a topological space (X, \mathcal{T}) into (Y_i, \mathcal{T}_i) . Further let $e : (X, \mathcal{T}) \rightarrow \prod_{i \in I} (Y_i, \mathcal{T}_i)$ be the **evaluation map**; that is, $e(x) = \prod_{i \in I} f_i(x)$, for all $x \in X$. Then e is a homeomorphism of (X, \mathcal{T}) onto the space $(e(X), \mathcal{T}')$, where \mathcal{T}' is the subspace topology on $e(X)$ if

- (i) each f_i is continuous.
- (ii) the family $\{f_i : i \in I\}$ **separates points** of X ; that is, if x_1 and x_2 are in X with $x_1 \neq x_2$, then for some $i \in I$, $f_i(x_1) \neq f_i(x_2)$, and
- (iii) the family $\{f_i : i \in I\}$ **separates points and closed sets**; that is, for $x \in X$ and A any closed subset of (X, \mathcal{T}) not containing x , $f_i(x) \notin \overline{f_i(A)}$, for some $i \in I$. □

10.1.10 Corollary. If (X, \mathcal{T}) in Lemma 10.1.9 is a T_1 -space, then condition (ii) is superfluous. □

10.1.11 Definitions. Let (X, \mathcal{T}) and (Y, \mathcal{T}') be topological spaces. Then we say that (X, \mathcal{T}) can be **embedded** in (Y, \mathcal{T}') if there exists a continuous mapping $f : (X, \mathcal{T}) \rightarrow (Y, \mathcal{T}')$, such that $f : (X, \mathcal{T}) \rightarrow (f(X), \mathcal{T}'')$ is a homeomorphism, where \mathcal{T}'' is the subspace topology on $f(X)$ from (Y, \mathcal{T}') . The mapping $f : (X, \mathcal{T}) \rightarrow (Y, \mathcal{T}')$ is said to be an **embedding**.

Exercises 10.1

1. For each $i \in I$, some index set, let (A_i, \mathcal{T}'_i) be a subspace of (X_i, \mathcal{T}_i) .
 - (i) Prove that $\prod_{i \in I} (A_i, \mathcal{T}'_i)$ is a subspace of $\prod_{i \in I} (X_i, \mathcal{T}_i)$.
 - (ii) Prove that $\prod_{i \in I} \overline{A_i} = \overline{\prod_{i \in I} A_i}$.
 - (iii) Prove that $\text{Int}(\prod_{i \in I} A_i) \subseteq \prod_{i \in I} (\text{Int}(A_i))$.
 - (iv) Give an example where equality does not hold in (iii).
2. Let J be any index set, and for each $j \in J$, (G_j, \mathcal{T}_j) a topological space homeomorphic to the Cantor Space, and I_j a topological space homeomorphic to $[0, 1]$. Prove that $\prod_{j \in J} I_j$ is a continuous image of $\prod_{j \in J} (G_j, \mathcal{T}_j)$.
3. Let $\{(X_j, \mathcal{T}_j) : j \in J\}$ be any infinite family of separable metrizable spaces. Prove that $\prod_{j \in J} (X_j, \mathcal{T}_j)$ is homeomorphic to a subspace of $\prod_{j \in J} I_j^\infty$, where each I_j^∞ is homeomorphic to the Hilbert cube.

4. (i) Let J be any infinite index set and $\{(X_{i,j}, \mathcal{T}_{i,j}) : i \in \mathbb{N} \text{ and } j \in J\}$ a family of homeomorphic topological spaces. Prove that

$$\prod_{j \in J} \left(\prod_{i \in \mathbb{N}} (X_{i,j}, \mathcal{T}_{i,j}) \right) \cong \prod_{j \in J} (X_{1,j}, \mathcal{T}_{1,j}).$$

- (ii) For each $j \in J$, any infinite index set, let (A_j, \mathcal{T}'_j) be homeomorphic to the discrete space $\{0, 2\}$ and (G_j, \mathcal{T}_j) homeomorphic to the Cantor Space. Deduce from (i) that

$$\prod_{j \in J} (A_j, \mathcal{T}'_j) \cong \prod_{j \in J} (G_j, \mathcal{T}_j).$$

- (iii) For each $j \in J$, any infinite index set, let I_j be homeomorphic to $[0, 1]$, and I_j^∞ homeomorphic to the Hilbert cube I^∞ . Deduce from (i) that

$$\prod_{j \in J} I_j \cong \prod_{j \in J} I_j^\infty.$$

- (iv) Let J, I_j, I_j^∞ , and (A_j, \mathcal{T}'_j) be as in (ii) and (iii). Prove that $\prod_{j \in J} I_j$ and $\prod_{j \in J} I_j^\infty$ are continuous images of $\prod_{j \in J} (A_j, \mathcal{T}'_j)$.
- (v) Let J and I_j be as in (iii). If, for each $j \in J$, (X_j, \mathcal{T}_j) is a separable metrizable space, deduce from #3 above and (iii) above that $\prod_{j \in J} (X_j, \mathcal{T}_j)$ is homeomorphic to a subspace of $\prod_{j \in J} I_j$.

10.2 Zorn's Lemma

Our next task is to prove the general Tychonoff Theorem which says that any product of compact spaces is compact. However, to do this we need to use Zorn's Lemma which requires a little preparation.

10.2.1 Definitions. A **partial order** on a set X is a binary relation, denoted by \leq , which has the properties:

(i) $x \leq x$, for all $x \in X$ (**reflexive**)

(ii) if $x \leq y$ and $y \leq x$, then $x = y$, for $x, y \in X$ (**antisymmetric**), and

(iii) if $x \leq y$ and $y \leq z$, then $x \leq z$, for $x, y, z \in X$ (**transitive**)

The set X equipped with the partial order \leq is called a **partially ordered set** and denoted by (X, \leq) . If $x \leq y$ and $x \neq y$, then we write $x < y$.

10.2.2 Examples. The prototype of a partially ordered set is the set \mathbb{N} of all natural numbers equipped with the usual ordering of natural numbers.

Similarly the sets \mathbb{Z} , \mathbb{Q} , and \mathbb{R} with their usual orderings form partially ordered sets. \square

10.2.3 Example. Let \mathbb{N} be the set of natural numbers and let \leq be defined as follows:

$$n \leq m \quad \text{if} \quad n \text{ divides } m$$

So $3 \leq 6$ but $3 \not\leq 5$. (It is left as an exercise to verify that with this ordering \mathbb{N} is a partially ordered set.) \square

10.2.4 Example. Let X be the class of all subsets of a set U . We can define a partial ordering on X by putting

$$A \leq B \quad \text{if} \quad A \text{ is a subset of } B$$

where A and B are in X .

It is easily verified that this is a partial order. \square

10.2.5 Example. Let (X, \leq) be a partially ordered set. We can define a new partial order \leq^* on X by defining

$$x \leq^* y \quad \text{if} \quad y \leq x.$$

\square

10.2.6 Example. There is a convenient way of picturing partially ordered sets; this is by an **order diagram**.

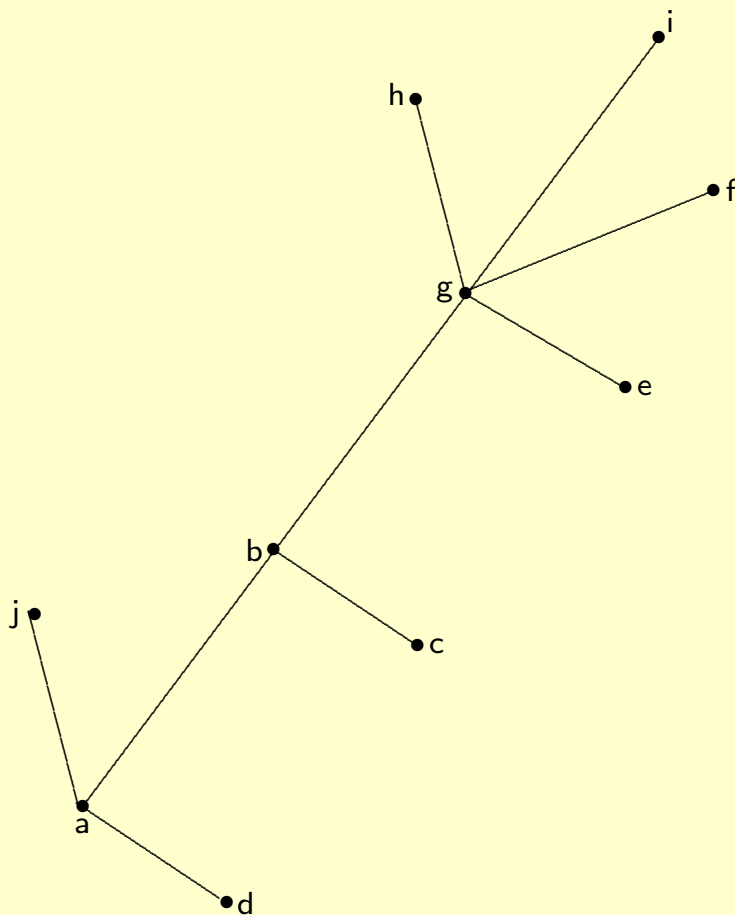

An element x is less than an element y if and only if one can go from x to y by moving upwards on line segments. So in our order diagram

$$\begin{aligned}
 &a < b, a < g, a < h, a < i, a < j, a < f, b < g, b < h, \\
 &b < i, b < f, c < b, c < f, c < g, c < h, c < i, d < a, d < b, \\
 &d < g, d < h, d < f, d < i, d < j, e < f, e < g, e < h, e < i, \\
 &f < g, f < h, g < h, g < i.
 \end{aligned}$$

However $d \not\leq c$ and $c \not\leq d$, $e \not\leq f$ and $f \not\leq e$, etc.

□

10.2.7 Definition. Two elements x and y of a partially ordered set (X, \leq) are said to be **comparable** if either $x \leq y$ or $y \leq x$.

10.2.8 Remark. We saw in the order diagram above that the elements d and c are not comparable. Also e and f are not comparable.

In \mathbb{N} , \mathbb{Q} , \mathbb{R} , and \mathbb{Z} with the usual orderings, every two elements are comparable.

In Example 10.2.4, 3 and 5 are not comparable. \square

10.2.9 Definitions. A partially ordered set (X, \leq) is said to be **linearly ordered** if every two elements are comparable. The order \leq is then said to a **linear order**.

10.2.10 Examples. The usual orders on \mathbb{R} , \mathbb{Q} , \mathbb{N} , and \mathbb{Z} are linear orders.

The partial order of Example 10.2.4 is not a linear order (if U has at least two points). \square

10.2.11 Definition. Let (X, \leq) be a partially ordered set. Then an element $s \in X$ is said to be the **greatest element** of X if $x \leq s$, for all $x \in X$.

10.2.12 Definition. Let (X, \leq) be a partially ordered set and Y a subset of X . An element $t \in X$ is said to be an **upper bound** for Y if $y \leq t$, for all $y \in Y$.

It is important to note that an upper bound for Y need not be in Y .

10.2.13 Definition. Let (X, \leq) be a partially ordered set. Then an element $w \in X$ is said to be **maximal** if $w \leq x$, with $x \in X$, implies $w = x$.

10.2.14 Remark. It is important to distinguish between maximal elements and greatest elements. Consider the order diagram in Example 10.2.6. There is no greatest element! However, j, h, i and f are all maximal elements. \square

10.2.15 Remark. We can now state Zorn's Lemma. Despite the name "Lemma", it is, in fact, an axiom and cannot be proved. It is equivalent to various other axioms of Set Theory such as the Axiom of Choice and the Well-Ordering Theorem. [See, for example, Halmos [96] or Wilder [223].] We shall take Zorn's Lemma as one of the axioms of our set theory and so use it whenever we wish.

10.2.16 Axiom. (Zorn's Lemma) Let (X, \leq) be a non-empty partially ordered set in which every subset which is linearly ordered has an upper bound. Then (X, \leq) has a maximal element.

10.2.17 Example. Let us apply Zorn's Lemma to the lattice diagram of Example 10.2.6. There are many linearly ordered subsets:

$$\begin{aligned} &\{i, g, b, a\}, \{g, b, a\}, \{b, a\}, \{g, b\}, \{i, g\}, \{a\}, \{b\}, \\ &\{g\}, \{i\}, \{i, b, a\}, \{i, g, a\}, \{i, a\}, \{g, a\}, \{h, g, e\}, \\ &\{h, e\}, \{g, e\}, \text{ etc.} \end{aligned}$$

Each of these has an upper bound — $i, i, i, i, i, i, i, i, i, i, i, i, h, h, h$, etc. Zorn's Lemma then says that there is a maximal element. In fact there are 4 maximal elements, j, h, f and i . \square

Exercises 10.2

1. Let $X = \{a, b, c, d, e, f, u, v\}$. Draw the order diagram of the partially ordered set (X, \leq) where

$$\begin{aligned} &v < a, v > b, v < c, v < d, v < e, v < f, v < u, \\ &a < c, a < d, a < e, a < f, a < u, \\ &b < c, b > d, b < e, b < f, b < u, \\ &c < d, c < e, c < f, c < u, \\ &d < e, d < f, d < u, \\ &e < u, f < u. \end{aligned}$$

2. In Example 10.2.3, state which of the following subsets of \mathbb{N} is linearly ordered:
- (a) $\{21, 3, 7\}$;
 - (b) $\{3, 6, 15\}$;
 - (c) $\{2, 6, 12, 72\}$;
 - (d) $\{1, 2, 3, 4, 5, \dots\}$;
 - (e) $\{5\}$.
3. Let (X, \leq) be a linearly ordered set. If x and y are maximal elements of X , prove that $x = y$.
4. Let (X, \leq) be a partially ordered set. If x and y are greatest elements of X , prove that $x = y$.
5. Let $X = \{2, 3, 4, 5, 6, 7, 8, 9, 10\}$ be partially ordered as follows:

$$x \leq y \quad \text{if } y \text{ is a multiple of } x.$$

Draw an order diagram and find all the maximal elements of (X, \leq) . Does (X, \leq) have a greatest element?

- 6.* Using Zorn's Lemma prove that every vector space V has a basis.
[Hints: (i) Consider first the case where $V = \{0\}$.

(ii) Assume $V \neq \{0\}$ and define

$$\mathcal{B} = \{B : B \text{ is a set of linearly independent vectors of } V.\}$$

Prove that $\mathcal{B} \neq \emptyset$.

(iii) Define a partial order \leq on \mathcal{B} by

$$B_1 \leq B_2 \text{ if } B_1 \subseteq B_2.$$

Let $\{B_i : i \in I\}$ be any linearly ordered subset of \mathcal{B} . Prove that $A = \bigcup_{i \in I} B_i$ is a linearly independent set of vectors of V .

(iv) Deduce that $A \in \mathcal{B}$ and so is an upper bound for $\{B_i : i \in I\}$.

(v) Apply Zorn's Lemma to show the existence of a maximal element of \mathcal{B} . Prove that this maximal element is a basis for V .]

10.3 Tychonoff's Theorem

10.3.1 Definition. Let X be a set and \mathcal{F} a family of subsets of X . Then \mathcal{F} is said to have the **finite intersection property** if for any finite number F_1, F_2, \dots, F_n of members of \mathcal{F} , $F_1 \cap F_2 \cap \dots \cap F_n \neq \emptyset$.

10.3.2 Proposition. Let (X, \mathcal{T}) be a topological space. Then (X, \mathcal{T}) is compact if and only if every family \mathcal{F} of closed subsets of X with the finite intersection property satisfies $\bigcap_{F \in \mathcal{F}} F \neq \emptyset$.

Proof. Assume that every family \mathcal{F} of closed subsets of X with the finite intersection property satisfies $\bigcap_{F \in \mathcal{F}} F \neq \emptyset$. Let \mathcal{U} be any open covering of X . Put \mathcal{F} equal to the family of complements of members of \mathcal{U} . So each $F \in \mathcal{F}$ is closed in (X, \mathcal{T}) . As \mathcal{U} is an open covering of X , $\bigcap_{F \in \mathcal{F}} F = \emptyset$. By our assumption, then, \mathcal{F} does not have the finite intersection property. So for some F_1, F_2, \dots, F_n in \mathcal{F} , $F_1 \cap F_2 \cap \dots \cap F_n = \emptyset$. Thus $U_1 \cup U_2 \cup \dots \cup U_n = X$, where $U_i = X \setminus F_i$, $i = 1, \dots, n$. So \mathcal{U} has a finite subcovering. Hence (X, \mathcal{T}) is compact.

The converse statement is proved similarly. □

10.3.3 Lemma. Let X be a set and \mathcal{F} a family of subsets of X with the finite intersection property. Then there is a maximal family of subsets of X that contains \mathcal{F} and has the finite intersection property.

Proof. Let Z be the collection of all families of subsets of X which contain \mathcal{F} and have the finite intersection property. Define a partial order \leq on Z as follows: if \mathcal{F}_1 and \mathcal{F}_2 are in Z then put $\mathcal{F}_1 \leq \mathcal{F}_2$ if $\mathcal{F}_1 \subseteq \mathcal{F}_2$. Let Y be any linearly ordered subset of Z . To apply Zorn's Lemma we need to verify that Y has an upper bound. We claim that $\bigcup_{\mathcal{Y} \in Y} \mathcal{Y}$ is an upper bound for Y . Clearly this contains \mathcal{F} , so we have to show only that it has the finite intersection property. So let $S_1, S_2, \dots, S_n \in \bigcup_{\mathcal{Y} \in Y} \mathcal{Y}$. Then each $S_i \in \mathcal{Y}_i$, for some $\mathcal{Y}_i \in Y$. As Y is linearly ordered, one of the \mathcal{Y}_i contains all of the others. Thus S_1, S_2, \dots, S_n all belong to that \mathcal{Y}_i . As \mathcal{Y}_i has the finite intersection property, $S_1 \cap S_2 \cap \dots \cap S_n \neq \emptyset$. Hence $\bigcup_{\mathcal{Y} \in Y} \mathcal{Y}$ has the finite intersection property and is, therefore, an upper bound in Z of Y . Thus by Zorn's Lemma, Z has a maximal element. \square

We can now prove the much heralded Tychonoff Theorem.

10.3.4 Theorem. (Tychonoff's Theorem) Let $\{(X_i, \mathcal{T}_i) : i \in I\}$ be any family of topological spaces. Then $\prod_{i \in I} (X_i, \mathcal{T}_i)$ is compact if and only if each (X_i, \mathcal{T}_i) is compact.

Proof. We shall use Proposition 10.3.2 to show that $(X, \mathcal{T}) = \prod_{i \in I} (X_i, \mathcal{T}_i)$ is compact, if each (X_i, \mathcal{T}_i) is compact. Let \mathcal{F} be any family of closed subsets of X with the finite intersection property. We have to prove that $\bigcap_{F \in \mathcal{F}} F \neq \emptyset$.

By Lemma 10.3.3 there is a maximal family \mathcal{H} of (not necessarily closed) subsets of (X, \mathcal{T}) that contains \mathcal{F} and has the finite intersection property. We shall prove that $\bigcap_{H \in \mathcal{H}} \overline{H} \neq \emptyset$, from which follows the required result $\bigcap_{F \in \mathcal{F}} F \neq \emptyset$, since each $F \in \mathcal{F}$ is closed.

As \mathcal{H} is maximal with the property that it contains \mathcal{F} and has the finite intersection property, if $H_1, H_2, \dots, H_n \in \mathcal{H}$, for any $n \in \mathbb{N}$, then the set $H' = H_1 \cap H_2 \cap \dots \cap H_n \in \mathcal{H}$. Suppose this was not the case. Then the set $\mathcal{H}' = \mathcal{H} \cup \{H'\}$ would properly contain \mathcal{H} and also have the property that it contains \mathcal{F} and has the finite intersection property. This is a contradiction to \mathcal{H} being maximal. So $\mathcal{H}' = \mathcal{H}$ and $H' = H_1 \cap H_2 \cap \dots \cap H_n \in \mathcal{H}$.

Let S be any subset of X that intersects non-trivially every member of \mathcal{H} . We claim that $\mathcal{H} \cup \{S\}$ has the finite intersection property. To see this let H'_1, H'_2, \dots, H'_m be members of \mathcal{H} . We shall show that $S \cap H'_1 \cap H'_2 \cap \dots \cap H'_m \neq \emptyset$. By the previous paragraph, $H'_1 \cap H'_2 \cap \dots \cap H'_m \in \mathcal{H}$. So by assumption $S \cap (H'_1 \cap H'_2 \cap \dots \cap H'_m) \neq \emptyset$. Hence $\mathcal{H} \cup \{S\}$ has the finite intersection property and contains \mathcal{F} . Again using the fact that \mathcal{H} is maximal with the property that it contains \mathcal{F} and has the finite intersection property, we see that $S \in \mathcal{H}$.

Fix $i \in I$ and let $p_i : \prod_{i \in I} (X_i, \mathcal{T}_i) \rightarrow (X_i, \mathcal{T}_i)$ be the projection mapping. Then the family $\{p_i(H) : H \in \mathcal{H}\}$ has the finite intersection property. Therefore the family $\{\overline{p_i(H)} : H \in \mathcal{H}\}$ has the finite intersection property. As (X_i, \mathcal{T}_i) is compact, $\bigcap_{H \in \mathcal{H}} \overline{p_i(H)} \neq \emptyset$. So let $x_i \in \bigcap_{H \in \mathcal{H}} \overline{p_i(H)}$. Then for each $i \in I$, we can find a point $x_i \in \bigcap_{H \in \mathcal{H}} \overline{p_i(H)}$. Put $x = \prod_{i \in I} x_i \in X$.

We shall prove that $x \in \bigcap_{H \in \mathcal{H}} \overline{H}$. Let O be any open set containing x . Then O contains a basic open set about x of the form $\bigcap_{i \in J} p_i^{-1}(U_i)$, where $U_i \in \mathcal{T}_i$, $x_i \in U_i$ and J is a finite subset of I . As $x_i \in \overline{p_i(H)}$, $U_i \cap p_i(H) \neq \emptyset$, for all $H \in \mathcal{H}$. Thus $p_i^{-1}(U_i) \cap H \neq \emptyset$, for all $H \in \mathcal{H}$. By the observation above, this implies that $p_i^{-1}(U_i) \in \mathcal{H}$, for all $i \in J$. As \mathcal{H} has the finite intersection property, $\bigcap_{i \in J} p_i^{-1}(U_i) \cap H \neq \emptyset$, for all $H \in \mathcal{H}$. So $O \cap H \neq \emptyset$ for all $H \in \mathcal{H}$. Hence $x \in \bigcap_{H \in \mathcal{H}} \overline{H}$, as required.

Conversely, if $\prod_{i \in I} (X_i, \mathcal{T}_i)$ is compact, then by Propositions 7.2.1 and 10.1.5 (i) each (X_i, \mathcal{T}_i) is compact. □

10.3.5 Notation. Let A be any set and for each $a \in A$ let the topological space (I_a, \mathcal{T}_a) be homeomorphic to $[0, 1]$. Then the product space $\prod_{a \in A} (I_a, \mathcal{T}_a)$ is denoted by I^A and referred to as a **cube**.

Observe that $I^{\mathbb{N}}$ is just the Hilbert cube which we also denote by I^∞ .

10.3.6 Corollary. For any set A , the cube I^A is compact.

10.3.7 Proposition. Let (X, d) be a metric space. Then it is homeomorphic to a subspace of the cube I^X .

Proof. Without loss of generality, assume $d(a, b) \leq 1$ for all a and b in X . For each $a \in X$, let f_a be the continuous mapping of (X, d) into $[0, 1]$ given by

$$f_a(x) = d(x, a).$$

That the family $\{f_a : a \in X\}$ separates points and closed sets is easily shown (cf. the proof of Theorem 9.4.11). Thus, by Corollary 10.1.10 of the Embedding Lemma, (X, d) is homeomorphic to a subspace of the cube I^X . \square

This leads us to ask: Which topological spaces are homeomorphic to subspaces of cubes? We now address this question.

10.3.8 Definitions. Let (X, \mathcal{T}) be a topological space. Then (X, \mathcal{T}) is said to be **completely regular** if for each $x \in X$ and each open set $U \ni x$, there exists a continuous function $f: (X, \mathcal{T}) \rightarrow [0, 1]$ such that $f(x) = 0$ and $f(y) = 1$ for all $y \in X \setminus U$. If (X, \mathcal{T}) is also Hausdorff, then it is said to be **Tychonoff space** (or a $T_{3\frac{1}{2}}$ -space).

10.3.9 Proposition. Let (X, d) be a metric space and \mathcal{T} the topology induced on X by d . Then (X, \mathcal{T}) is a Tychonoff space.

Proof. Let $a \in X$ and U be any open set containing a . Then U contains an open ball with centre a and radius ε , for some $\varepsilon > 0$. Define $f : (X, d) \rightarrow [0, 1]$ by

$$f(x) = \min \left\{ 1, \frac{d(x, a)}{\varepsilon} \right\}, \quad \text{for } x \in X.$$

Then f is continuous and satisfies $f(a) = 0$ and $f(y) = 1$, for all $y \in X \setminus U$. As (X, d) is also Hausdorff, it is a Tychonoff space. \square

10.3.10 Corollary. The space $[0, 1]$ is a Tychonoff space. \square

10.3.11 Proposition. If $\{(X_i, \mathcal{T}_i) : i \in I\}$ is any family of completely regular spaces, then $\prod_{i \in I} (X_i, \mathcal{T}_i)$ is completely regular.

Proof. Let $a = \prod_{i \in I} a_i \in \prod_{i \in I} X_i$ and U be any open set containing a . Then there exists a finite subset J of I and sets $U_i \in \mathcal{T}_i$ such that

$$a \in \prod_{i \in I} U_i \subseteq U$$

where $U_i = X_i$ for all $i \in I \setminus J$. As (X_j, \mathcal{T}_j) is completely regular for each $j \in J$, there exists a continuous mapping $f_j : (X_j, \mathcal{T}_j) \rightarrow [0, 1]$ such that $f_j(a_j) = 0$ and $f_j(y) = 1$, for all $y \in X_j \setminus U_j$. Then $f_j \circ p_j : \prod_{i \in I} (X_i, \mathcal{T}_i) \rightarrow [0, 1]$, where p_j denotes the projection of $\prod_{i \in I} (X_i, \mathcal{T}_i)$ onto (X_j, \mathcal{T}_j) .

If we put $f(x) = \max\{f_j \circ p_j(x) : j \in J\}$, for all $x \in \prod_{i \in I} X_i$, then $f : \prod_{i \in I} (X_i, \mathcal{T}_i) \rightarrow [0, 1]$ is continuous (as J is finite). Further, $f(a) = 0$ while $f(y) = 1$ for all $y \in X \setminus U$. So $\prod_{i \in I} (X_i, \mathcal{T}_i)$ is completely regular. \square

The next proposition is easily proved and so its proof is left as an exercise.

10.3.12 Proposition. If $\{(X_i, \mathcal{T}_i) : i \in I\}$ is any family of Hausdorff spaces, then $\prod_{i \in I} (X_i, \mathcal{T}_i)$ is Hausdorff.

Proof. Exercise. □

10.3.13 Corollary. If $\{(X_i, \mathcal{T}_i) : i \in I\}$ is any family of Tychonoff spaces, then $\prod_{i \in I} (X_i, \mathcal{T}_i)$ is a Tychonoff space. □

10.3.14 Corollary. For any set X , the cube I^X is a Tychonoff space. □

10.3.15 Proposition. Every subspace of a completely regular space is completely regular.

Proof. Exercise. □

10.3.16 Corollary. Every subspace of a Tychonoff space is a Tychonoff space.

Proof. Exercise. □

10.3.17 Proposition. If (X, \mathcal{T}) is any Tychonoff space, then it is homeomorphic to a subspace of a cube.

Proof. Let \mathcal{F} be the family of all continuous mappings $f : (X, \mathcal{T}) \rightarrow [0, 1]$. Then it follows easily from Corollary 10.1.10 of the Embedding Lemma and the definition of completely regular, that the evaluation map $e : (X, \mathcal{T}) \rightarrow I^{\mathcal{F}}$ is an embedding. □

Thus we now have a characterization of the subspaces of cubes. Putting together Proposition 10.3.17 and Corollaries 10.3.14 and 10.3.16 we obtain:

10.3.18 Proposition. A topological space (X, \mathcal{T}) can be embedded in a cube if and only if it is a Tychonoff space. \square

10.3.19 Remark. We now proceed to show that the class of Tychonoff spaces is quite large and, in particular, includes all compact Hausdorff spaces.

10.3.20 Definitions. A topological space (X, \mathcal{T}) is said to be a **normal space** if for each pair of disjoint closed sets A and B , there exist open sets U and V such that $A \subseteq U$, $B \subseteq V$ and $U \cap V = \emptyset$. A normal space which is also Hausdorff is said to be a **T_4 -space**.

10.3.21 Remark. In Exercises 6.1 #9 it is noted that every metrizable space is a normal space. A little later we shall verify that every compact Hausdorff space is normal. First we shall prove that every normal Hausdorff space is a Tychonoff space (that is, every T_4 -space is a $T_{3\frac{1}{2}}$ -space).

10.3.22 Theorem. (Urysohn's Lemma) Let (X, \mathcal{T}) be a topological space. Then (X, \mathcal{T}) is normal if and only if for each pair of disjoint closed sets A and B in (X, \mathcal{T}) there exists a continuous function $f: (X, \mathcal{T}) \rightarrow [0, 1]$ such that $f(a) = 0$ for all $a \in A$, and $f(b) = 1$ for all $b \in B$.

Proof. Assume that for each A and B an f with the property stated above exists. Then $U = f^{-1}([0, \frac{1}{2}))$ and $V = f^{-1}((\frac{1}{2}, 1])$ are open in (X, \mathcal{T}) and satisfy $A \subseteq U$, $B \subseteq V$, and $A \cap B = \emptyset$. Hence (X, \mathcal{T}) is normal.

Conversely, assume (X, \mathcal{T}) is normal. We shall construct a family $\{U_i : i \in D\}$ of open subsets of X , where the set D is given by $D = \{\frac{k}{2^n} : k = 1, 2, \dots, 2^n, n \in \mathbb{N}\}$.

So D is a set of dyadic rational numbers, such that $A \subseteq U_i$, $U_i \cap B = \emptyset$, and $d_1 \leq d_2$ implies $U_{d_1} \subseteq U_{d_2}$. As (X, \mathcal{T}) is normal, for any pair A, B of disjoint closed sets, there exist disjoint open sets $U_{\frac{1}{2}}$ and $V_{\frac{1}{2}}$ such that $A \subseteq U_{\frac{1}{2}}$ and $B \subseteq V_{\frac{1}{2}}$. So we have $A \subseteq U_{\frac{1}{2}} \subseteq V_{\frac{1}{2}}^C \subseteq B^C$ where the superscript C is used to denote complements in X (that is, $V_{\frac{1}{2}}^C = X \setminus V_{\frac{1}{2}}$ and $B^C = X \setminus B$).

Now consider the disjoint closed sets A and $U_{\frac{1}{2}}^C$. Again, by normality, there exist disjoint open sets $U_{\frac{1}{4}}$ and $V_{\frac{1}{4}}$ such that $A \subseteq U_{\frac{1}{4}}$ and $U_{\frac{1}{2}}^C \subseteq V_{\frac{1}{4}}$. Also as $V_{\frac{1}{2}}^C$ and B are disjoint closed sets there exists disjoint open sets $U_{\frac{3}{4}}$ and $V_{\frac{3}{4}}$ such that $V_{\frac{1}{2}}^C \subseteq U_{\frac{3}{4}}$ and $B \subseteq V_{\frac{3}{4}}$. So we have

$$A \subseteq U_{\frac{1}{4}} \subseteq V_{\frac{1}{4}}^C \subseteq U_{\frac{1}{2}} \subseteq V_{\frac{1}{2}}^C \subseteq U_{\frac{3}{4}} \subseteq V_{\frac{3}{4}}^C \subseteq B^C.$$

Continuing by induction we obtain open sets U_d and V_d , for each $d \in D$, such that

$$A \subseteq U_{2^{-n}} \subseteq V_{2^{-n}}^C \subseteq U_{2 \cdot 2^{-n}} \subseteq V_{2 \cdot 2^{-n}}^C \subseteq \dots \subseteq U_{(2^{n-1})2^{-n}} \subseteq V_{(2^{n-1})2^{-n}}^C \subseteq B^C.$$

So we have, in particular, that for $d_1 \leq d_2$ in D , $U_{d_1} \subseteq U_{d_2}$.

Now we define $f: (X, \mathcal{T}) \rightarrow [0, 1]$ by $f(x) = \begin{cases} \inf\{d : x \in U_d\}, & \text{if } x \in \bigcup_{d \in D} U_d \\ 1, & \text{if } x \notin \bigcup_{d \in D} U_d. \end{cases}$

Observe finally that since $A \subseteq U_d$, for all $d \in D$, $f(a) = 0$ for all $a \in A$. Also if $b \in B$, then $b \notin \bigcup_{d \in D} U_d$ and so $f(b) = 1$. So we have to show only that f is continuous.

Let $f(x) = y$, where $y \neq 0, 1$ and set $W = (y - \varepsilon, y + \varepsilon)$, for some $\varepsilon > 0$ (with $0 < y - \varepsilon < y + \varepsilon < 1$). As D is dense in $[0, 1]$, we can choose d_0 and d_1 such that $y - \varepsilon < d_0 < y < d_1 < y + \varepsilon$. Then, by the definition of f , $x \in U = U_{d_1} \setminus \overline{U_{d_0}}$ and the open set U satisfies $f(U) \subseteq W$. If $y = 1$ then we put $W = (y - \varepsilon, 1]$, choose d_0 such that $y - \varepsilon < d_0 < 1$, and set $U = X \setminus \overline{U_{d_0}}$. Again $f(U) \subseteq W$. Finally, if $y = 0$ then put $W = [0, y + \varepsilon)$, choose d_1 such that $0 < d_1 < Y + \varepsilon$ and set $U = U_{d_1}$ to again obtain $f(U) \subseteq W$. Hence f is continuous. □

10.3.23 Corollary. If (X, \mathcal{T}) is a Hausdorff normal space then it is a Tychonoff space; that is, every T_4 -space is a $T_{3\frac{1}{2}}$ -space. Consequently it is homeomorphic to a subspace of a cube.

□

10.3.24 Proposition. Every compact Hausdorff space (X, \mathcal{T}) is normal.

Proof. Let A and B be disjoint closed subsets of (X, \mathcal{T}) . Fix $b \in B$. Then, as (X, \mathcal{T}) is Hausdorff, for each $a \in A$, there exist open sets U_a and V_a such that $a \in U_a$, $b \in V_a$ and $U_a \cap V_a = \emptyset$. So $\{U_a : a \in A\}$ is an open covering of A . As A is compact, there exists a finite subcovering $U_{a_1}, U_{a_2}, \dots, U_{a_n}$. Put $U_b = U_{a_1} \cup U_{a_2} \cup \dots \cup U_{a_n}$ and $V_b = V_{a_1} \cap V_{a_2} \cap \dots \cap V_{a_n}$. Then we have $A \subseteq U_b$, $b \in V_b$, and $U_b \cap V_b = \emptyset$. Now let b vary throughout B , so we obtain an open covering $\{V_b : b \in B\}$ of B . As B is compact, there exists a finite subcovering $V_{b_1}, V_{b_2}, \dots, V_{b_m}$. Set $V = V_{b_1} \cup V_{b_2} \cup \dots \cup V_{b_m}$ and $U = U_{b_1} \cap U_{b_2} \cap \dots \cap U_{b_m}$. Then $A \subseteq U$, $B \subseteq V$, and $U \cap V = \emptyset$. Hence (X, \mathcal{T}) is normal. □

10.3.25 Corollary. Every compact Hausdorff space can be embedded in a cube. □

10.3.26 Remark. We can now prove the Urysohn metrization theorem which provides a sufficient condition for a topological space to be metrizable. It also provides a necessary and sufficient condition for a compact space to be metrizable – namely that it be Hausdorff and second countable.

10.3.27 Definitions. A topological space (X, \mathcal{T}) is said to be **regular** if for each $x \in X$ and each $U \in \mathcal{T}$ such that $x \in U$, there exists a $V \in \mathcal{T}$ with $x \in \bar{V} \subseteq U$. If (X, \mathcal{T}) is also Hausdorff it is said to be a **T_3 -space**.

10.3.28 Remark. It is readily verified that every $T_{3\frac{1}{2}}$ -space is a T_3 -space. So, from Corollary 10.3.23, every T_4 -space is a T_3 -space. Indeed we now have a hierarchy:

$$\text{compact Hausdorff} \Rightarrow T_4 \Rightarrow T_{3\frac{1}{2}} \Rightarrow T_3 \Rightarrow T_2 \Rightarrow T_1 \Rightarrow T_0$$

$$\text{metrizable} \Rightarrow T_4 \Rightarrow T_{3\frac{1}{2}} \Rightarrow T_3 \Rightarrow T_2 \Rightarrow T_1 \Rightarrow T_0$$

□

10.3.29 Proposition. Every normal second countable Hausdorff space (X, \mathcal{T}) is metrizable.

Proof. It suffices to show that (X, \mathcal{T}) can be embedded in the Hilbert cube I^∞ . By Corollary 9.4.10, to verify this it is enough to find a countable family of continuous maps of (X, \mathcal{T}) into $[0, 1]$ which separates points and closed sets.

Let \mathcal{B} be a countable basis for \mathcal{T} , and consider the set \mathcal{S} of all pairs (V, U) such that $U \in \mathcal{B}$, $V \in \mathcal{B}$ and $\overline{V} \subseteq U$. Then \mathcal{S} is countable. For each pair (V, U) in \mathcal{S} we can, by Urysohn's Lemma, find a continuous mapping $f_{VU}: (X, \mathcal{T}) \rightarrow [0, 1]$ such that $f_{VU}(\overline{V}) = 0$ and $f_{VU}(X \setminus U) = 1$. Put \mathcal{F} equal to the family of functions, f , so obtained. Then \mathcal{F} is countable.

To see that \mathcal{F} separates points and closed sets, let $x \in X$ and W any open set containing x . Then there exists a $U \in \mathcal{B}$ such that $x \in U \subseteq W$. By Remark 10.3.28, (X, \mathcal{T}) is regular and so there exists a set $P \in \mathcal{T}$ such that $x \in P \subseteq \overline{P} \subseteq U$. Therefore there exists a $V \in \mathcal{B}$ with $x \in V \subseteq P$. So $x \in \overline{V} \subseteq \overline{P} \subseteq U$. Then $(V, U) \in \mathcal{S}$ and if f_{VU} is the corresponding mapping in \mathcal{F} , then $f_{VU}(x) = 0 \notin \overline{\{1\}} = \overline{f_{VU}(X \setminus W)}$. □

10.3.30 Lemma. Every regular second countable space (X, \mathcal{T}) is normal.

Proof. Let A and B be disjoint closed subsets of (X, \mathcal{T}) and \mathcal{B} a countable basis for \mathcal{T} . As (X, \mathcal{T}) is regular and $X \setminus B$ is an open set, for each $a \in A$ there exists a $V_a \in \mathcal{B}$ such that $\bar{V}_a \subseteq X \setminus B$.

As \mathcal{B} is countable we can list the members $\{V_a : a \in A\}$ so obtained by $V_i, i \in \mathbb{N}$; that is, $A \subseteq \bigcup_{i=1}^{\infty} V_i$ and $\bar{V}_i \cap B = \emptyset$, for all $i \in \mathbb{N}$.

Similarly we can find sets U_i in \mathcal{B} , $i \in \mathbb{N}$, such that $B \subseteq \bigcup_{i=1}^{\infty} U_i$ and $\bar{U}_i \cap A = \emptyset$, for all $i \in \mathbb{N}$.

Now define $U'_1 = U_1 \setminus \bar{V}_1$ and $V'_1 = V_1 \setminus \bar{U}_1$.

So $U'_1 \cap V'_1 = \emptyset$, $U'_1 \in \mathcal{T}$, $V'_1 \in \mathcal{T}$, $U'_1 \cap B = U_1 \cap B$, and $V'_1 \cap A = V_1 \cap A$.

Then we inductively define

$$\bar{U}'_n = U_n \setminus \bigcup_{i=1}^n \bar{V}_i \quad \text{and} \quad V'_n = V_n \setminus \bigcup_{i=1}^n \bar{U}_i$$

So that $U'_n \in \mathcal{T}$, $V'_n \in \mathcal{T}$, $U'_n \cap B = U_n \cap B$, and $V'_n \cap A = V_n \cap A$.

Now put $U = \bigcup_{n=1}^{\infty} U'_n$ and $V = \bigcup_{n=1}^{\infty} V'_n$.

Then $U \cap V = \emptyset$, $U \in \mathcal{T}$, $V \in \mathcal{T}$, $A \subseteq V$, and $B \subseteq U$.

Hence (X, \mathcal{T}) is a normal space. □

We can now deduce from Proposition 10.3.29. and Lemma 10.3.30 the Urysohn Metrization Theorem, which generalizes Proposition 10.3.29.

10.3.31 Theorem. (Urysohn's Metrization Theorem) Every regular second countable Hausdorff space is metrizable. □

From Urysohn's Metrization Theorem, Proposition 9.4.4, and Proposition 9.4.17, we deduce the following characterization of metrizability for compact spaces.

10.3.32 Corollary. A compact space is metrizable if and only if it is Hausdorff and second countable. □

10.3.33 Remark. As mentioned in Remark 10.3.21, every metrizable space is normal. It then follows from Proposition 9.4.17 that every separable metric space is normal, Hausdorff, and second countable. Thus Uryshohn's Theorem 9.4.11, which says that every separable metric space is homeomorphic to a subspace of the Hilbert cube, is a consequence of (the proof of) Proposition 10.3.29.

Exercises 10.3

1. A topological space (X, \mathcal{T}) is said to be a **Lindelöf space** if every open covering of X has a countable subcovering. Prove the following statements.
 - (i) Every regular Lindelöf space is normal.
 [Hint: use a method like that in Lemma 10.3.30. Note that we saw in Exercises 9.4 #8 that every second countable space is Lindelöf.]
 - (ii) The Sorgenfrey line $(\mathbb{R}, \mathcal{T}_1)$ is a Lindelöf space.
 - (iii) If (X, \mathcal{T}) is a topological space which has a closed uncountable discrete subspace, then (X, \mathcal{T}) is not a Lindelöf space.
 - (iv) It follows from (iii) above and Exercises 8.1 #12 that the product space $(\mathbb{R}, \mathcal{T}_1) \times (\mathbb{R}, \mathcal{T}_1)$ is not a Lindelöf space.
 [Now we know from (ii) and (iv) that **a product of two Lindelöf spaces is not necessarily a Lindelöf space.**]
2. Prove that any product of regular spaces is a regular space.
3. Verify that any closed subspace of a normal space is a normal space.
4. If (X, \mathcal{T}) is an infinite connected Tychonoff space, prove that X is uncountable.

5. A Hausdorff space (X, \mathcal{T}) is said to be a k_ω -space if there is a countable collection $X_n, n \in \mathbb{N}$ of compact subsets of X , such that
- $X_n \subseteq X_{n+1}$, for all n ,
 - $X = \bigcup_{n=1}^{\infty} X_n$,
 - any subset A of X is closed if and only if $A \cap X_n$ is compact for each $n \in \mathbb{N}$.

Prove that

- every compact Hausdorff space is a k_ω -space,
 - every countable discrete space is a k_ω -space,
 - \mathbb{R} and \mathbb{R}^2 are k_ω -spaces,
 - every k_ω -space is a normal space;
 - every metrizable k_ω -space is separable;
 - every metrizable k_ω -space can be embedded in the Hilbert cube;
 - every closed subspace of a k_ω -space is a k_ω -space;
 - if (X, \mathcal{T}) and (Y, \mathcal{T}') are k_ω -spaces then $(X, \mathcal{T}) \times (Y, \mathcal{T}')$ is a k_ω -space.
6. Prove that every $T_{3\frac{1}{2}}$ -space is a T_3 -space.
7. Prove that for metrizable spaces the conditions (i) Lindelöf space, (ii) separable, and (iii) second countable, are equivalent.

8. A topological space (X, \mathcal{T}) is said to satisfy the **first axiom of countability** (or to be **first countable**) if for each $x \in X$, there exists a countable family $U_i, i \in \mathbb{N}$ of open sets containing x , such that if $V \in \mathcal{T}$ and $x \in V$, then $V \supseteq U_{n'}$ for some n .
- (i) Prove that every metrizable space is first countable.
 - (ii) Verify that every second countable space is first countable, but that the converse is false. (Hint: Consider discrete spaces.)
 - (iii) If $\{(X_i, \mathcal{T}_i) : i \in \mathbb{N}\}$, is a countable family of first countable spaces, prove that $\prod_{i=1}^{\infty} (X_i, \mathcal{T}_i)$ is first countable.
 - (iv) Verify that every subspace of a first countable space is first countable.
 - (v) Let X be any uncountable set. Prove that the cube I^X is not first countable, and hence is not metrizable.
[Note that I^X is an example of a [compact Hausdorff and hence] normal space which is not metrizable.]
 - (vi) Generalize (v) above to show that if J is any uncountable set and each (X_j, \mathcal{T}_j) is a topological space with more than one point, then $\prod_{j \in J} (X_j, \mathcal{T}_j)$ is not metrizable.
9. Prove that **the class of all Tychonoff spaces is the smallest class of topological spaces that contains $[0, 1]$ and is closed under the formation of subspaces and cartesian products.**
10. Prove that any subspace of a completely regular space is a completely regular space.
11. Using Proposition 8.6.8, prove that if (G, \mathcal{T}) is a topological group, then (G, \mathcal{T}) is a regular space.
[It is indeed true that every topological group is a completely regular space, but this is much harder to prove.]
12. If $\{(X_i, \mathcal{T}_i) : i \in I\}$ is any family of connected spaces, prove that $\prod_{i \in I} (X_i, \mathcal{T}_i)$ is connected.
[Hint: Let $x = \prod_{i \in I} x_i \in \prod_{i \in I} X_i$. Let S consists of the set of all points in $\prod_{i \in I} X_i$ which differ from $x = \prod_{i \in I} x_i$ in at most a finite number of coordinates. Prove that $C_X(x) \supseteq S$. Then show that S is dense in $\prod_{i \in I} (X_i, \mathcal{T}_i)$. Finally use the fact that $C_X(x)$ is a closed set].

13. Let $\{(X_j, \mathcal{T}_j) : j \in J\}$ be any family of topological spaces. Prove that $\prod_{j \in J} (X_j, \mathcal{T}_j)$ is locally connected if and only if each (X_j, \mathcal{T}_j) is locally connected and all but a finite number of (X_j, \mathcal{T}_j) are also connected.
14. Let $(\mathbb{R}, \mathcal{T}_1)$ be the Sorgenfrey line. Prove the following statements.
- (i) $(\mathbb{R}, \mathcal{T}_1)$ is a normal space.
 - (ii) If (X, \mathcal{T}) is a separable Hausdorff space, then there are at most \mathfrak{c} distinct continuous functions $f : (X, \mathcal{T}) \rightarrow [0, 1]$.
 - (iii) If (X, \mathcal{T}) is a normal space which has an uncountable closed discrete subspace, then there are at least $2^{\mathfrak{c}}$ distinct continuous functions $f : (X, \mathcal{T}) \rightarrow [0, 1]$. [Hint: Use Urysohn's Lemma.]
 - (iv) Deduce from (ii) and (iii) above and Exercises 8.1 #12, that $(\mathbb{R}, \mathcal{T}_1) \times (\mathbb{R}, \mathcal{T}_1)$ is not a normal space.
[We now know that [the product of two normal spaces is not necessarily a normal space.](#)]

10.4 Stone-Čech Compactification

10.4.1 Definition. Let (X, \mathcal{T}) be a topological space, $(\beta X, \mathcal{T}')$ a compact Hausdorff space and $\beta: (X, \mathcal{T}) \rightarrow (\beta X, \mathcal{T}')$ a continuous mapping, then $(\beta X, \mathcal{T}')$ together with the mapping β is said to be the **Stone-Čech compactification** of (X, \mathcal{T}) if for any compact Hausdorff space (Y, \mathcal{T}'') and any continuous mapping $\phi: (X, \mathcal{T}) \rightarrow (Y, \mathcal{T}'')$, there exists a unique continuous mapping $\Phi: (\beta X, \mathcal{T}') \rightarrow (Y, \mathcal{T}'')$ such that $\Phi \circ \beta = \phi$; that is, the diagram below commutes:

$$\begin{array}{ccc}
 (X, \mathcal{T}) & \xrightarrow{\beta} & (\beta X, \mathcal{T}') \\
 & \searrow \phi & \downarrow \Phi \\
 & & (Y, \mathcal{T}'')
 \end{array}$$

WARNING The mapping β is usually not surjective, so $\beta(X)$ is usually not equal to βX .

10.4.2 Remark. Those familiar with category theory should immediately recognize that the existence of the Stone-Čech compactification follows from the Freyd Adjoint Functor Theorem the forgetful functor from the category of compact Hausdorff spaces and continuous functions to the category of topological spaces and continuous functions.] For a discussion of this see Maclane [148].

While the Stone-Čech compactification exists for all topological spaces, it assumes more significance in the case of Tychonoff spaces. For the mapping β is an embedding if and only if the space (X, \mathcal{T}) is Tychonoff. The “only if” part of this is clear, since the compact Hausdorff space $(\beta X, \mathcal{T}')$ is a Tychonoff space and so, therefore, is any subspace of it.

We now address the task of proving the existence of the Stone-Čech compactification for Tychonoff spaces and of showing that the map β is an embedding in this case.

10.4.3 Lemma. Let (X, \mathcal{T}) and (Y, \mathcal{T}') be Tychonoff spaces and $\mathcal{F}(X)$ and $\mathcal{F}(Y)$ the family of all continuous mappings of X and Y into $[0, 1]$, respectively. Further let e_X and e_Y be the evaluation maps of X into $\prod_{f \in \mathcal{F}(X)} I_f$ and Y into $\prod_{g \in \mathcal{F}(Y)} I_g$, respectively, where $I_f \cong I_g \cong [0, 1]$, for each f and g . If ϕ is any continuous mapping of X into Y , then there exists a continuous mapping Φ of $\prod_{f \in \mathcal{F}(X)} I_f$ into $\prod_{g \in \mathcal{F}(Y)} I_g$ such that $\Phi \circ e_X = e_Y \circ \phi$; that is, the diagram below commutes.

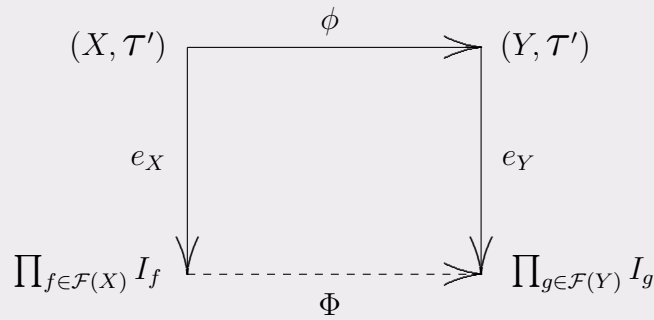

Further, $\Phi(\overline{e_X(X)}) \subseteq \overline{e_Y(Y)}$.

Proof. Let $\prod_{f \in \mathcal{F}(X)} x_f \in \prod_{f \in \mathcal{F}(X)} I_f$. Define $\Phi\left(\prod_{f \in \mathcal{F}(X)} x_f\right) = \prod_{g \in \mathcal{F}(Y)} y_g$, where y_g is defined as follows: as $g \in \mathcal{F}(Y)$, g is continuous map from (Y, \mathcal{T}') into $[0, 1]$. So $g \circ \phi$ is a continuous map from (X, \mathcal{T}) into $[0, 1]$. Thus $g \circ \phi = f$, for some $f \in \mathcal{F}(X)$. Then put $y_g = x_f$, for this f , and the mapping Φ is now defined.

To prove continuity of Φ , let $U = \prod_{g \in \mathcal{F}(Y)} U_g$ be a basic open set containing $\Phi\left(\prod_{f \in \mathcal{F}(X)} x_f\right) = \prod_{g \in \mathcal{F}(Y)} y_g$. Then $U_g = I_g$ for all $g \in \mathcal{F}(Y) \setminus \{g_{i_1}, \dots, g_{i_n}\}$, for g_{i_1}, \dots, g_{i_n} . Put $f_{i_1} = g_{i_1} \circ \phi, f_{i_2} = g_{i_2} \circ \phi, \dots, f_{i_n} = g_{i_n} \circ \phi$. Now define $V = \prod_{f \in \mathcal{F}(X)} V_f$, where $V_f = I_f$, for some $f \in \mathcal{F}(X) \setminus \{f_{i_1}, f_{i_2}, \dots, f_{i_n}\}$, and $V_{f_{i_1}} = U_{g_{i_1}}, V_{f_{i_2}} = U_{g_{i_2}}, \dots, V_{f_{i_n}} = U_{g_{i_n}}$. Clearly $\prod_{f \in \mathcal{F}(X)} x_f \in V$ and $\Phi(V) \subseteq U$. So Φ is continuous.

To see that the diagram commutes, observe that

$$\Phi(e_X(x)) = \Phi\left(\prod_{f \in \mathcal{F}(X)} f(x)\right) = \prod_{g \in \mathcal{F}(Y)} g(\phi(x)), \text{ for all } x \in X.$$

So $\Phi \circ e_X = e_Y \circ \phi$.

Finally as Φ is continuous, $\Phi(\overline{e_X(X)}) \subseteq \overline{e_Y(Y)}$, as required. □

10.4.4 Lemma. Let Φ_1 and Φ_2 be continuous mappings of a topological space (X, \mathcal{T}) into the Hausdorff space (Y, \mathcal{T}') . If Z is a dense subset of (X, \mathcal{T}) and $\Phi_1(z) = \Phi_2(z)$ for all $z \in Z$, then $\Phi_1 = \Phi_2$ on X .

Proof. Suppose $\Phi_1(x) \neq \Phi_2(x)$, for some $x \in X$. Then as (Y, \mathcal{T}') is Hausdorff, there exist open sets $U \ni \Phi_1(x)$ and $V \ni \Phi_2(x)$, with $U \cap V = \emptyset$. So $\Phi_1^{-1}(U) \cap \Phi_2^{-1}(V)$ is an open set containing x .

As Z is dense in (X, \mathcal{T}) , there exists a $z \in Z$ such that $z \in \Phi_1^{-1}(U) \cap \Phi_2^{-1}(V)$. So $\Phi_1(z) \in U$ and $\Phi_2(z) \in V$. But $\Phi_1(z) = \Phi_2(z)$. So $U \cap V \neq \emptyset$, which is a contradiction.

Hence $\Phi_1(x) = \Phi_2(x)$, for all $x \in X$. □

10.4.5 Proposition. Let (X, \mathcal{T}) be any Tychonoff space, $\mathcal{F}(X)$ the family of continuous mappings of (X, \mathcal{T}) into $[0, 1]$, and e_X the evaluation map of (X, \mathcal{T}) into $\prod_{f \in \mathcal{F}(X)} I_f$, where each $I_f \cong [0, 1]$. Put $(\beta X, \mathcal{T}')$ equal to $\overline{e_X(X)}$ with the subspace topology and $\beta : (X, \mathcal{T}) \rightarrow (\beta X, \mathcal{T}')$ equal to the mapping e_X . Then $(\beta X, \mathcal{T}')$ together with the mapping β is the Stone-Čech compactification of (X, \mathcal{T}) .

Proof. Firstly observe that $(\beta X, \mathcal{T}')$ is indeed a compact Hausdorff space, as it is a closed subspace of a compact Hausdorff space.

Let ϕ be any continuous mapping of (X, \mathcal{T}) into any compact Hausdorff space (Y, \mathcal{T}'') . We are required to find a mapping Φ as in Definition 10.4.1 so that the diagram there commutes and show that ϕ is unique.

Let $\mathcal{F}(Y)$ be the family of all continuous mappings of (Y, \mathcal{T}'') into $[0, 1]$ and e_Y the evaluation mapping of (Y, \mathcal{T}'') into $\prod_{g \in \mathcal{F}(Y)} I_g$, where each $I_g \cong [0, 1]$.

By Lemma 10.4.3, there exists a continuous mapping $\Gamma : \prod_{f \in \mathcal{F}(X)} I_f \rightarrow \prod_{g \in \mathcal{F}(Y)} I_g$, such that $e_Y \circ \phi = \Gamma \circ e_X$, and $\Gamma(\overline{e_X(X)}) \subseteq \overline{e_Y(Y)}$; that is, $\Gamma(\beta X) \subseteq \overline{e_Y(Y)}$.

As (Y, \mathcal{T}'') is a compact Hausdorff space and e_Y is one-to-one, we see that $\overline{e_Y(Y)} = e_Y(Y)$ and $e_Y : (Y, \mathcal{T}'') \rightarrow (e_Y(Y), \mathcal{T}''')$ is a homeomorphism, where \mathcal{T}''' is the subspace topology on $e_Y(Y)$. So $e_Y^{-1} : (e_Y(Y), \mathcal{T}''') \rightarrow (Y, \mathcal{T}'')$ is a homeomorphism.

Put $\Phi = e_Y^{-1} \circ \Gamma$ so that Φ is a continuous mapping of $(\beta X, \mathcal{T}')$ into (Y, \mathcal{T}'') . Further,

$$\begin{aligned} \Phi(\beta(x)) &= \Phi(e_X(x)), \quad \text{for any } x \in X \\ &= e_Y^{-1}(\Gamma(e_X(x))) \\ &= e_Y^{-1}(e_Y(\phi(x))), \quad \text{as } e_Y \circ \phi = \Gamma \circ e_X \\ &= \phi(x). \end{aligned}$$

Thus $\Phi \circ \beta = \phi$, as required.

Now suppose there exist two continuous mappings Φ_1 and Φ_2 of $(\beta X, \mathcal{T}')$ into (Y, \mathcal{T}'') with $\Phi_1 \circ \beta = \phi$ and $\Phi_2 \circ \beta = \phi$. Then $\Phi_1 = \Phi_2$ on the dense subset $\beta(X)$ of $(\beta X, \mathcal{T}')$. So by Lemma 10.4.4, $\Phi_1 = \Phi_2$. Hence the mapping Φ is unique. \square

10.4.6 Remark. In Definition 10.4.1 we have referred to the Stone-Čech compactification implying that for each (X, \mathcal{T}) there is a unique $(\beta X, \mathcal{T}')$. The next Proposition indicates in precisely what sense this is true. However we first need a lemma.

10.4.7 Lemma. Let (X, \mathcal{T}) be a topological space and let (Z, \mathcal{T}_1) together with a mapping $\beta: (X, \mathcal{T}) \rightarrow (Z, \mathcal{T}_1)$ be a Stone-Čech compactification of (X, \mathcal{T}) . Then $\beta(X)$ is dense in (Z, \mathcal{T}_1) .

Proof. Suppose $\beta(X)$ is not dense in (Z, \mathcal{T}_1) . Then there exists an element $z \in Z \setminus \overline{\beta(X)}$. As (Z, \mathcal{T}_1) is a compact Hausdorff space, by Remark 10.3.28, it is a Tychonoff space.

Observing that $Z \setminus \overline{\beta(X)}$ is an open set containing z , we deduce that there exists a continuous mapping $\Phi_1: (Z, \mathcal{T}_1) \rightarrow [0, 1]$ with $\Phi_1(z) = 1$ and $\Phi_1(\overline{\beta(X)}) = 0$. Also there exists a continuous mapping $\Phi_2: (Z, \mathcal{T}_1) \rightarrow [0, \frac{1}{2}]$ with $\Phi_2(z) = \frac{1}{2}$ and $\Phi_2(\overline{\beta(X)}) = 0$. So we have the following diagrams which commute

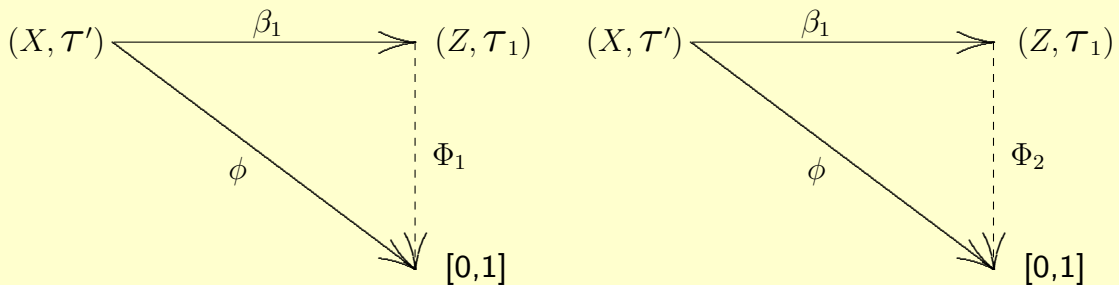

where $\phi(x) = 0$, for all $x \in X$. This contradicts the uniqueness of the mapping Φ in Definition 10.4.1. Hence $\beta(X)$ is dense in (Z, \mathcal{T}_1) . □

10.4.8 Proposition. Let (X, \mathcal{T}) be a topological space and (Z_1, \mathcal{T}_1) together with a mapping $\beta_1: (X, \mathcal{T}) \rightarrow (Z_1, \mathcal{T}_1)$ a Stone-Čech compactification of (X, \mathcal{T}) . If (Z_2, \mathcal{T}_2) together with a mapping $\beta_2: (X, \mathcal{T}) \rightarrow (Z_2, \mathcal{T}_2)$ is also a Stone-Čech compactification of (X, \mathcal{T}) then $(Z_1, \mathcal{T}_1) \cong (Z_2, \mathcal{T}_2)$. Indeed, there exists a homeomorphism $\Theta: (Z_1, \mathcal{T}_1) \rightarrow (Z_2, \mathcal{T}_2)$ such that $\Theta \circ \beta_1 = \beta_2$.

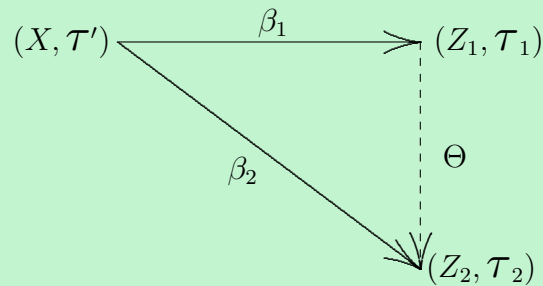

Proof. As (Z_1, \mathcal{T}_1) together with β_1 is a Stone-Čech compactification of (X, \mathcal{T}) and β_2 is a continuous mapping of (X, \mathcal{T}) into the compact Hausdorff space (Z_2, \mathcal{T}_2) , there exists a continuous mapping $\Theta: (Z_1, \mathcal{T}_1) \rightarrow (Z_2, \mathcal{T}_2)$, such that $\Theta \circ \beta_1 = \beta_2$.

Similarly there exists a continuous map $\Theta_1: (Z_2, \mathcal{T}_2) \rightarrow (Z_1, \mathcal{T}_1)$ such that $\Theta_1 \circ \beta_2 = \beta_1$. So for each $x \in X$, $\Theta_1(\Theta(\beta_1(x))) = \Theta_1(\beta_2(x)) = \beta_1(x)$; that is, if id_{Z_1} is the identity mapping on (Z_1, \mathcal{T}_1) then $\Theta_1 \circ \Theta = \text{id}_{Z_1}$ on $\beta_1(X)$, which by Lemma 10.4.7 is dense in (Z_1, \mathcal{T}_1) . So, by Lemma 10.4.4, $\Theta_1 \circ \Theta = \text{id}_{Z_1}$ on Z_1 .

Similarly $\Theta \circ \Theta_1 = \text{id}_{Z_2}$ on Z_2 . Hence $\Theta = \Theta_1^{-1}$ and as both are continuous this means that Θ is a homeomorphism. \square

10.4.9 Remark. Note that **if (X, \mathcal{T}) is any Tychonoff space** and $(\beta X, \mathcal{T}')$ together with $\beta: (X, \mathcal{T}) \rightarrow (\beta X, \mathcal{T}')$ is its Stone-Čech compactification then the proof of Proposition 10.4.5 shows that β is an embedding. Indeed **it is usual**, in this case, **to identify X with βX , and so regard (X, \mathcal{T}) as a subspace of $(\beta X, \mathcal{T}')$** . We, then, do not mention the embedding β and talk about $(\beta X, \mathcal{T}')$ as the Stone-Čech compactification.

10.4.10 Remark. For (X, \mathcal{T}) a compact Hausdorff space, the Stone-Čech compactification of (X, \mathcal{T}) is (X, \mathcal{T}) itself. Obviously (X, \mathcal{T}) together with the identity mapping into itself has the required property of a Stone-Čech compactification. By uniqueness, it is the Stone-Čech compactification. This could also be seen from the proof of Proposition 10.4.5 where we saw that for the compact Hausdorff space (Y, \mathcal{T}'') the mapping $e_Y: (Y, \mathcal{T}'') \rightarrow (e_Y(Y), \mathcal{T}''')$ is a homeomorphism.

10.4.11 Remark. Stone-Čech compactifications of even nice spaces are usually complicated. For example $[0, 1]$ is not the Stone-Čech compactification of $(0, 1]$, since the continuous mapping $\phi: (0, 1] \rightarrow [-1, 1]$ given by $\phi(x) = \sin(\frac{1}{x})$ does not extend to a continuous map $\Phi: [0, 1] \rightarrow [-1, 1]$. Indeed it can be shown that the Stone-Čech compactification of $(0, 1]$ is not metrizable.

Exercises 10.4

1. Let (X, \mathcal{T}) be a Tychonoff space and $(\beta X, \mathcal{T}')$ its Stone-Čech compactification. Prove that (X, \mathcal{T}) is connected if and only if $(\beta X, \mathcal{T}')$ is connected.

[Hint: Firstly verify that providing (X, \mathcal{T}) has at least 2 points it is connected if and only if there does not exist a continuous map of (X, \mathcal{T}) onto the discrete space $\{0, 1\}$.]

2. Let (X, \mathcal{T}) be a Tychonoff space and $(\beta X, \mathcal{T}')$ its Stone-Čech compactification. If (A, \mathcal{T}_1) is a subspace of $(\beta X, \mathcal{T}')$ and $A \supseteq X$, prove that $(\beta X, \mathcal{T}')$ is also the Stone-Čech compactification of (A, \mathcal{T}_1) .

[Hint: Verify that every continuous mapping of (X, \mathcal{T}) into $[0, 1]$ can be extended to a continuous mapping of (A, \mathcal{T}_1) into $[0, 1]$. Then use the construction of $(\beta X, \mathcal{T}')$.]

3. Let (X, \mathcal{T}) be a dense subspace of a compact Hausdorff space (Z, \mathcal{T}_1) . If every continuous mapping of (X, \mathcal{T}) into $[0, 1]$ can be extended to a continuous mapping of (Z, \mathcal{T}_1) into $[0, 1]$, prove that (Z, \mathcal{T}_1) is the Stone-Čech compactification of (X, \mathcal{T}) .

10.5 Postscript

At long last we defined the product of an arbitrary number of topological spaces and proved the general Tychonoff Theorem. We also extended the Embedding Lemma to the general case. This we used to characterize the Tychonoff spaces as those which are homeomorphic to a subspace of a cube (that is, a product of copies of $[0, 1]$).

Urysohn's Lemma allowed us to obtain the following relations between the the separation properties:

$$T_4 \Rightarrow T_{3\frac{1}{2}} \Rightarrow T_3 \Rightarrow T_2 \Rightarrow T_1 \Rightarrow T_0.$$

Further, both compact Hausdorff and metrizable imply T_4 .

We have also seen a serious metrization theorem – namely Urysohn's Metrization Theorem, which says that every regular second countable Hausdorff space is metrizable.

We concluded the chapter by introducing the Stone-Čech compactification which is a serious topic of study in its own right. (See Hindman and Strauss [104] and Walker [217].)

Appendix 1: Infinite Sets

Introduction

Once upon a time in a far-off land there were two hotels, the Hotel Finite (an ordinary hotel with a finite number of rooms) and Hilbert's Hotel Infinite (an extra-ordinary hotel with an infinite number of rooms numbered $1, 2, \dots, n, \dots$). One day a visitor arrived in town seeking a room. She went first to the Hotel Finite and was informed that all rooms were occupied and so she could not be accommodated, but she was told that the other hotel, Hilbert's Hotel Infinite, can always find an extra room. So she went to Hilbert's Hotel Infinite and was told that there too all rooms were occupied. However, the desk clerk said at this hotel an extra guest can always be accommodated without evicting anyone. He moved the guest from room 1 to room 2, the guest from room 2 to room 3, and so on. Room 1 then became vacant!

From this cute example we see that there is an intrinsic difference between infinite sets and finite sets. The aim of this Appendix is to provide a gentle but very brief introduction to the theory of Infinite Sets. This is a fascinating topic which, if you have not studied it before, will contain several surprises. We shall learn that "infinite sets were not created equal" - some are bigger than others. At first pass it is not at all clear what this statement could possibly mean. We will need to define the term "bigger". Indeed we will need to define what we mean by "two sets are the same size".

A1.1 Countable Sets

A1.1.1 Definitions. Let A and B be sets. Then A is said to be **equipotent** to B , denoted by $A \sim B$, if there exists a function $f : A \rightarrow B$ which is both one-to-one and onto (that is, f is a **bijection** or a **one-to-one correspondence**).

A1.1.2 Proposition. Let A , B , and C be sets.

- (i) Then $A \sim A$.
- (ii) If $A \sim B$ then $B \sim A$.
- (iii) If $A \sim B$ and $B \sim C$ then $A \sim C$.

Outline Proof.

- (i) The identity function f on A , given by $f(x) = x$, for all $x \in A$, is a one-to-one correspondence between A and itself.
- (ii) If f is a bijection of A onto B then it has an inverse function g from B to A and g is also a one-to-one correspondence.
- (iii) If $f : A \rightarrow B$ is a one-to-one correspondence and $g : B \rightarrow C$ is a one-to-one correspondence, then their composition $gf : A \rightarrow C$ is also a one-to-one correspondence. \square

Proposition A1.1.2 says that the relation “ \sim ” is reflexive (i), symmetric (ii), and transitive (iii); that is, “ \sim ” is an **equivalence relation**.

A1.1.3 Proposition. Let $n, m \in \mathbb{N}$. Then the sets $\{1, 2, \dots, n\}$ and $\{1, 2, \dots, m\}$ are equipotent if and only if $n = m$.

Proof. Exercise. \square

Now we explicitly define the terms “finite set” and “infinite set”.

A1.1.4 Definitions. Let S be a set.

- (i) Then S is said to be **finite** if it is the empty set, \emptyset , or it is equipotent to $\{1, 2, \dots, n\}$, for some $n \in \mathbb{N}$.
- (ii) If S is not finite, then it is said to be **infinite**.
- (iii) If $S \sim \{1, 2, \dots, n\}$ then S is said to have **cardinality** n , which is denoted by **card** $S = n$.
- (iv) If $S = \emptyset$ then the cardinality is said to be 0, which is denoted by **card** $\emptyset = 0$.

The next step is to define the “smallest” kind of infinite set. Such sets will be called countably infinite. At this stage we do not know that there is any “bigger” kind of infinite set – indeed we do not even know what “bigger” would mean in this context.

A1.1.5 Definitions. Let S be a set.

- (i) The set S is said to be **countably infinite** (or **denumerable**) if it is equipotent to \mathbb{N} .
- (ii) The set S is said to be **countable** if it is finite or countably infinite.
- (iii) If S is countably infinite then it is said to have **cardinality** \aleph_0 , denoted by **card** $S = \aleph_0$.
- (iv) A set S is said to be **uncountable** if it is not countable.

A1.1.6 Remark. We see that if the set S is countably infinite, then $S = \{s_1, s_2, \dots, s_n, \dots\}$ where $f : \mathbb{N} \rightarrow S$ is a one-to-one correspondence and $s_n = f(n)$, for all $n \in \mathbb{N}$. So we can **list** the elements of S . Of course if S is finite and non-empty, we can also list its elements by $S = \{s_1, s_2, \dots, s_n\}$. So we can list the elements of any countable set. Conversely, **if the elements of S can be listed then S is countable** as the listing defines a one-to-one correspondence with \mathbb{N} or $\{1, 2, \dots, n\}$. □

A1.1.7 Example. The set S of all even positive integers is countably infinite.

Proof. The function $f : \mathbb{N} \rightarrow S$ given by $f(n) = 2n$, for all $n \in \mathbb{N}$, is a one-to-one correspondence. □

Example A1.1.7 is worthy of a little contemplation. We think of two sets being in one-to-one correspondence if they are “the same size”. But here we have the set \mathbb{N} in one-to-one correspondence with one of its proper subsets. This does not happen with finite sets. Indeed finite sets can be characterized as those sets which are not equipotent to any of their proper subsets.

A1.1.8 Example. The set \mathbb{Z} of all integers is countably infinite.

Proof. The function $f : \mathbb{N} \rightarrow \mathbb{Z}$ given by

$$f(n) = \begin{cases} m, & \text{if } n = 2m, m \geq 1 \\ -m, & \text{if } n = 2m + 1, m \geq 1 \\ 0, & \text{if } n = 1. \end{cases}$$

is a one-to-one correspondence. □

A1.1.9 Example. The set S of all positive integers which are perfect squares is countably infinite.

Proof. The function $f : \mathbb{N} \rightarrow S$ given by $f(n) = n^2$ is a one-to-one correspondence. □

Example A1.1.9 was proved by G. Galileo about 1600. It troubled him and suggested to him that the infinite is not man’s domain.

A1.1.10 Proposition. If a set S is equipotent to a countable set then it is countable.

Proof. Exercise. □

A1.1.11 Proposition. If S is a countable set and $T \subset S$ then T is countable.

Proof. Since S is countable we can write it as a list $S = \{s_1, s_2, \dots\}$ (a finite list if S is finite, an infinite one if S is countably infinite).

Let t_1 be the first s_i in T (if $T \neq \emptyset$). Let t_2 be the second s_i in T (if $T \neq \{t_1\}$). Let t_3 be the third s_i in T (if $T \neq \{t_1, t_2\}$), \dots

This process comes to an end only if $T = \{t_1, t_2, \dots, t_n\}$ for some n , in which case T is finite. If the process does not come to an end we obtain a list $\{t_1, t_2, \dots, t_n, \dots\}$ of members of T . This list contains every member of T , because if $s_i \in T$ then we reach s_i no later than the i^{th} step in the process; so s_i occurs in the list. Hence T is countably infinite. So T is either finite or countably infinite. □

As an immediate consequence of Proposition 1.1.11 and Example 1.1.8 we have the following result.

A1.1.12 Corollary. Every subset of \mathbb{Z} is countable. □

A1.1.13 Lemma. If $S_1, S_2, \dots, S_n, \dots$ is a countably infinite family of countably infinite sets such that $S_i \cap S_j = \emptyset$ for $i \neq j$, then $\bigcup_{i=1}^{\infty} S_i$ is a countably infinite set.

Proof. As each S_i is a countably infinite set, $S_i = \{s_{i1}, s_{i2}, \dots, s_{in}, \dots\}$. Now put the s_{ij} in a square array and list them by zigzagging up and down the short diagonals.

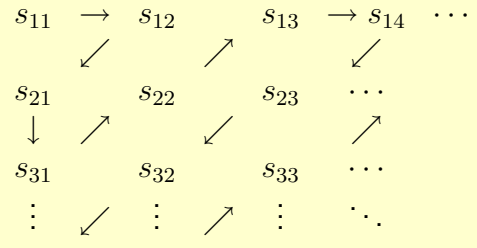

This shows that all members of $\bigcup_{i=1}^{\infty} S_i$ are listed, and the list is infinite because each S_i is infinite. So $\bigcup_{i=1}^{\infty} S_i$ is countably infinite. □

In Lemma A1.1.13 we assumed that the sets S_i were pairwise disjoint. If they are not pairwise disjoint the proof is easily modified by deleting repeated elements to obtain:

A1.1.14 Lemma. If $S_1, S_2, \dots, S_n, \dots$ is a countably infinite family of countably infinite sets, then $\bigcup_{i=1}^{\infty} S_i$ is a countably infinite set. \square

A1.1.15 Proposition. The union of any countable family of countable sets is countable.

Proof. Exercise. \square

A1.1.16 Proposition. If S and T are countably infinite sets then the product set $S \times T = \{\langle s, t \rangle : s \in S, t \in T\}$ is a countably infinite set.

Proof. Let $S = \{s_1, s_2, \dots, s_n, \dots\}$ and $T = \{t_1, t_2, \dots, t_n, \dots\}$. Then

$$S \times T = \bigcup_{i=1}^{\infty} \{\langle s_i, t_1 \rangle, \langle s_i, t_2 \rangle, \dots, \langle s_i, t_n \rangle, \dots\}.$$

So $S \times T$ is a countably infinite union of countably infinite sets and is therefore countably infinite. \square

A1.1.17 Corollary. Every finite product of countable sets is countable. \square

We are now ready for a significant application of our observations on countable sets.

A1.1.18 Lemma. The set, $\mathbb{Q}^{>0}$, of all positive rational numbers is countably infinite.

Proof. Let S_i be the set of all positive rational numbers with denominator i , for $i \in \mathbb{N}$. Then $S_i = \{\frac{1}{i}, \frac{2}{i}, \dots, \frac{n}{i}, \dots\}$ and $\mathbb{Q}^{>0} = \bigcup_{i=1}^{\infty} S_i$. As each S_i is countably infinite, Proposition A1.1.15 yields that $\mathbb{Q}^{>0}$ is countably infinite. \square

We are now ready to prove that the set, \mathbb{Q} , of all rational numbers is countably infinite; that is, there exists a one-to-one correspondence between the set \mathbb{Q} and the (seemingly) very much smaller set, \mathbb{N} , of all positive integers.

A1.1.19 Theorem. The set \mathbb{Q} of all rational numbers is countably infinite.

Proof. Clearly the set $\mathbb{Q}^{<0}$ of all negative rational numbers is equipotent to the set, $\mathbb{Q}^{>0}$, of all positive rational numbers and so using Proposition A1.1.10 and Lemma A1.1.18 we obtain that $\mathbb{Q}^{<0}$ is countably infinite.

Finally observe that \mathbb{Q} is the union of the three sets $\mathbb{Q}^{>0}$, $\mathbb{Q}^{<0}$ and $\{0\}$ and so it too is countably infinite by Proposition A1.1.15. \square

A1.1.20 Corollary. Every set of rational numbers is countable.

Proof. This is a consequence of Theorem A1.1.19 and Proposition A1.1.11. \square

A1.1.21 Definitions. A real number x is said to be an **algebraic number** if there is a natural number n and integers a_0, a_1, \dots, a_n with $a_0 \neq 0$ such that

$$a_0x^n + a_1x^{n-1} + \dots + a_{n-1}x + a_n = 0.$$

A real number which is not an algebraic number is said to be a **transcendental number**.

A1.1.22 Example. Every rational number is an algebraic number.

Proof. If $x = \frac{p}{q}$, for $p, q \in \mathbb{Z}$ and $q \neq 0$, then $qx - p = 0$; that is, x is an algebraic number with $n = 1$, $a_0 = q$, and $a_n = -p$. \square

A1.1.23 Example. The number $\sqrt{2}$ is an algebraic number which is not a rational number.

Proof. While $x = \sqrt{2}$ is irrational, it satisfies $x^2 - 2 = 0$ and so is algebraic. \square

A1.1.24 Remark. It is also easily verified that $\sqrt[4]{5} - \sqrt{3}$ is an algebraic number since it satisfies $x^8 - 12x^6 + 44x^4 - 288x^2 + 16 = 0$. Indeed any real number which can be constructed from the set of integers using only a finite number of the operations of addition, subtraction, multiplication, division and the extraction of square roots, cube roots, . . . , is algebraic. \square

A1.1.25 Remark. Remark A1.1.24 shows that “most” numbers we think of are algebraic numbers. To show that a given number is transcendental can be extremely difficult. The first such demonstration was in 1844 when Liouville proved the transcendence of the number

$$\sum_{n=1}^{\infty} \frac{1}{10^{n!}} = 0.110001000000000000000000100\dots$$

It was Charles Hermite who, in 1873, showed that e is transcendental. In 1882 Lindemann proved that the number π is transcendental thereby answering in the negative the 2,000 year old question about squaring the circle. (The question is: given a circle of radius 1, is it possible, using only a straight edge and compass, to construct a square with the same area? A full exposition of this problem and proofs that e and π are transcendental are to be found in the book, Jones, Morris & Pearson [128].) \square

We now proceed to prove that the set \mathcal{A} of all algebraic numbers is also countably infinite. This is a more powerful result than Theorem A1.1.19 which is in fact a corollary of this result.

A1.1.26 Theorem. The set \mathcal{A} of all algebraic numbers is countably infinite.

Proof. Consider the polynomial $f(x) = a_0x^n + a_1x^{n-1} + \cdots + a_{n-1}x + a_n$, where $a_0 \neq 0$ and each $a_i \in \mathbb{Z}$ and define its **height** to be $k = n + |a_0| + |a_1| + \cdots + |a_n|$.

For each positive integer k , let A_k be the set of all roots of all such polynomials of height k . Clearly $\mathcal{A} = \bigcup_{k=1}^{\infty} A_k$.

Therefore, to show that \mathcal{A} is countably infinite, it suffices by Proposition A1.1.15 to show that each A_k is finite.

If f is a polynomial of degree n , then clearly $n \leq k$ and $|a_i| \leq k$ for $i = 1, 2, \dots, n$. So the set of all polynomials of height k is certainly finite.

Further, a polynomial of degree n has at most n roots. Consequently each polynomial of height k has no more than k roots. Hence the set A_k is finite, as required. \square

A1.1.27 Corollary. Every set of algebraic numbers is countable. \square

Note that Corollary A1.1.27 has as a special case, Corollary A1.1.20.

So far we have not produced any example of an uncountable set. Before doing so we observe that certain mappings will not take us out of the collection of countable sets.

A1.1.28 Proposition. Let X and Y be sets and f a map of X into Y .

- (i) If X is countable and f is surjective (that is, an onto mapping), then Y is countable.
- (ii) If Y is countable and f is injective (that is, a one-to-one mapping), then X is countable.

Proof. Exercise. \square

A1.1.29 Proposition. Let S be a countable set. Then the set of all finite subsets of S is also countable.

Proof. Exercise. \square

A1.1.30 Definition. Let S be any set. The set of all subsets of S is said to be the **power set** of S and is denoted by $\mathcal{P}(S)$.

A1.1.31 Theorem. (Georg Cantor) For every set S , the power set, $\mathcal{P}(S)$, is not equipotent to S ; that is, $\mathcal{P}(S) \not\sim S$.

Proof. We have to prove that there is no one-to-one correspondence between S and $\mathcal{P}(S)$. We shall prove more: that there is not even any surjective function mapping S onto $\mathcal{P}(S)$.

Suppose that there exists a function $f: S \rightarrow \mathcal{P}(S)$ which is onto. For each $x \in S$, $f(x) \in \mathcal{P}(S)$, which is the same as saying that $f(x) \subseteq S$.

Let $T = \{x : x \in S \text{ and } x \notin f(x)\}$. Then $T \subseteq S$; that is, $T \in \mathcal{P}(S)$. So $T = f(y)$ for some $y \in S$, since f maps S onto $\mathcal{P}(S)$. Now $y \in T$ or $y \notin T$.

Case 1.

$$\begin{aligned} y \in T &\Rightarrow y \notin f(y) \quad (\text{by the definition of } T) \\ &\Rightarrow y \notin T \quad (\text{since } f(y) = T). \end{aligned}$$

So Case 1 is impossible.

Case 2.

$$\begin{aligned} y \notin T &\Rightarrow y \in f(y) \quad (\text{by the definition of } T) \\ &\Rightarrow y \in T \quad (\text{since } f(y) = T). \end{aligned}$$

So Case 2 is impossible.

As both cases are impossible, we have a contradiction. So our supposition is false and there does not exist any function mapping S onto $\mathcal{P}(S)$. Thus $\mathcal{P}(S)$ is not equipotent to S . \square

A1.1.32 Lemma. If S is any set, then S is equipotent to a subset of its power set, $\mathcal{P}(S)$.

Proof. Define the mapping $f: S \rightarrow \mathcal{P}(S)$ by $f(x) = \{x\}$, for each $x \in S$. Clearly f is a one-to-one correspondence between the sets S and $f(S)$. So S is equipotent to the subset $f(S)$ of $\mathcal{P}(S)$. \square

A1.1.33 Proposition. If S is any infinite set, then $\mathcal{P}(S)$ is an uncountable set.

Proof. As S is infinite, the set $\mathcal{P}(S)$ is infinite. By Theorem A1.1.31, $\mathcal{P}(S)$ is not equipotent to S .

Suppose $\mathcal{P}(S)$ is countably infinite. Then by Proposition A1.1.11, Lemma 1.1.32 and Proposition A1.1.10, S is countably infinite. So S and $\mathcal{P}(S)$ are equipotent, which is a contradiction. Hence $\mathcal{P}(S)$ is uncountable. \square

Proposition A1.1.33 demonstrates the existence of uncountable sets. However the sceptic may feel that the example is contrived. So we conclude this section by observing that important and familiar sets are uncountable.

A1.1.34 Lemma. The set of all real numbers in the half open interval $[1, 2)$ is not countable.

Proof. (Cantor's diagonal argument) We shall show that the set of all real numbers in $[1, 2)$ cannot be listed.

Let $L = \{r_1, r_2, \dots, r_n, \dots\}$ be any list of real numbers each of which lies in the set $[1, 2)$. Write down their decimal expansions:

$$\begin{aligned} r_1 &= 1.r_{11}r_{12} \dots r_{1n} \dots \\ r_2 &= 1.r_{21}r_{22} \dots r_{2n} \dots \\ &\vdots \\ r_m &= 1.r_{m1}r_{m2} \dots r_{mn} \dots \\ &\vdots \end{aligned}$$

Consider the real number a defined to be $1.a_1a_2 \dots a_n \dots$ where, for each $n \in \mathbb{N}$,

$$a_n = \begin{cases} 1 & \text{if } r_{nn} \neq 1 \\ 2 & \text{if } r_{nn} = 1. \end{cases}$$

Clearly $a_n \neq r_{nn}$ and so $a \neq r_n$, for all $n \in \mathbb{N}$. Thus a does not appear anywhere in the list L . Thus there does not exist a listing of the set of all real numbers in $[1, 2)$; that is, this set is uncountable. □

A1.1.35 Theorem. The set, \mathbb{R} , of all real numbers is uncountable.

Proof. Suppose \mathbb{R} is countable. Then by Proposition A1.1.11 the set of all real numbers in $[1, 2)$ is countable, which contradicts Lemma A1.1.34. Therefore \mathbb{R} is uncountable. □

A1.1.36 Corollary. The set, \mathbb{I} , of all irrational numbers is uncountable.

Proof. Suppose \mathbb{I} is countable. Then \mathbb{R} is the union of two countable sets: \mathbb{I} and \mathbb{Q} . By Proposition A1.1.15, \mathbb{R} is countable which is a contradiction. Hence \mathbb{I} is uncountable. \square

Using a similar proof to that in Corollary A1.1.36 we obtain the following result.

A1.1.37 Corollary. The set of all transcendental numbers is uncountable. \square

A1.2 Cardinal Numbers

In the previous section we defined countably infinite and uncountable and suggested, without explaining what it might mean, that uncountable sets are “bigger” than countably infinite sets. To explain what we mean by “bigger” we will need the next theorem.

Our exposition is based on that in the book, Halmos [96]

A1.2.1 Theorem. (Cantor-Schröder-Bernstein) Let S and T be sets. If S is equipotent to a subset of T and T is equipotent to a subset of S , then S is equipotent to T .

Proof. Without loss of generality we can assume S and T are disjoint. Let $f : S \rightarrow T$ and $g : T \rightarrow S$ be one-to-one maps. We are required to find a bijection of S onto T .

We say that an element s is a **parent** of an element $f(s)$ and $f(s)$ is a **descendant** of s . Also t is a parent of $g(t)$ and $g(t)$ is a descendant of t . Each $s \in S$ has an infinite sequence of descendants: $f(s), g(f(s)), f(g(f(s)))$, and so on. We say that each term in such a sequence is an **ancestor** of all the terms that follow it in the sequence.

Now let $s \in S$. If we trace its ancestry back as far as possible one of three things must happen:

- (i) the list of ancestors is finite, and stops at an element of S which has no ancestor;
- (ii) the list of ancestors is finite, and stops at an element of T which has no ancestor;
- (iii) the list of ancestors is infinite.

Let S_S be the set of those elements in S which originate in S ; that is, S_S is the set $S \setminus g(T)$ plus all of its descendants in S . Let S_T be the set of those elements which originate in T ; that is, S_T is the set of descendants in S of $T \setminus f(S)$. Let S_∞ be the set of all elements in S with no parentless ancestors. Then S is the union of the three disjoint sets S_S, S_T and S_∞ . Similarly T is the disjoint union of the three similarly defined sets: T_T, T_S , and T_∞ .

Clearly the restriction of f to S_S is a bijection of S_S onto T_S .

Now let g^{-1} be the inverse function of the bijection g of T onto $g(T)$. Clearly the restriction of g^{-1} to S_T is a bijection of S_T onto T_T .

Finally, the restriction of f to S_∞ is a bijection of S_∞ onto T_∞ .

Define $h : S \rightarrow T$ by

$$h(s) = \begin{cases} f(s) & \text{if } s \in S_S \\ g^{-1}(s) & \text{if } s \in S_T \\ f(s) & \text{if } s \in S_\infty. \end{cases}$$

Then h is a bijection of S onto T . So S is equipotent to T . □

Our next task is to define what we mean by “cardinal number”.

A1.2.2 Definitions. A collection, \aleph , of sets is said to be a **cardinal number** if it satisfies the conditions:

- (i) Let S and T be sets. If S and T are in \aleph , then $S \sim T$;
- (ii) Let A and B be sets. If A is in \aleph and $B \sim A$, then B is in \aleph .

If \aleph is a cardinal number and A is a set in \aleph , then we write **card** $A = \aleph$.

Definitions A1.2.2 may, at first sight, seem strange. A cardinal number is defined as a collection of sets. So let us look at a couple of special cases:

If a set A has two elements we write $\text{card } A = 2$; the cardinal number 2 is the collection of all sets equipotent to the set $\{1, 2\}$, that is the collection of all sets with 2 elements.

If a set S is countable infinite, then we write $\text{card } S = \aleph_0$; in this case the cardinal number \aleph_0 is the collection of all sets equipotent to \mathbb{N} .

Let S and T be sets. Then S is equipotent to T if and only if $\text{card } S = \text{card } T$.

A1.2.3 Definitions. The cardinality of \mathbb{R} is denoted by **c**; that is, $\text{card } \mathbb{R} = \mathfrak{c}$. The cardinality of \mathbb{N} is denoted by \aleph_0 .

The symbol \mathfrak{c} is used in Definitions A1.2.3 as we think of \mathbb{R} as the “continuum”.

We now define an ordering of the cardinal numbers.

A1.2.4 Definitions. Let m and n be cardinal numbers. Then the cardinal m is said to be less than or equal to n , that is $m \leq n$, if there are sets S and T such that $\text{card } m = S$, $\text{card } T = n$, and S is equipotent to a subset of T . Further, the cardinal m is said to be strictly less than n , that is $m < n$, if $m \leq n$ and $m \neq n$.

As \mathbb{R} has \mathbb{N} as a subset, $\text{card } \mathbb{R} = \mathfrak{c}$ and $\text{card } \mathbb{N} = \aleph_0$, and \mathbb{R} is not equipotent to \mathbb{N} , we immediately deduce the following result.

A1.2.5 Proposition. $\aleph_0 < \mathfrak{c}$. □

We also know that for any set S , S is equipotent to a subset of $\mathcal{P}(S)$, and S is not equipotent to $\mathcal{P}(S)$, from which we deduce the next result.

A1.2.6 Theorem. For any set S , $\text{card } S < \text{card } \mathcal{P}(S)$. □

The following is a restatement of the Cantor-Schröder-Bernstein Theorem.

A1.2.7 Theorem. Let m and n be cardinal numbers. If $m \leq n$ and $n \leq m$, then $m = n$. □

A1.2.8 Remark. We observe that [there are an infinite number of infinite cardinal numbers](#). This is clear from the fact that:

$$(*) \quad \aleph_0 = \text{card } \mathbb{N} < \text{card } \mathcal{P}(\mathbb{N}) < \text{card } \mathcal{P}(\mathcal{P}(\mathbb{N})) < \dots \quad \square$$

The next result is an immediate consequence of Theorem A1.2.6.

A1.2.9 Corollary. There is no largest cardinal number. □

Noting that if a finite set S has n elements, then its power set $\mathcal{P}(S)$ has 2^n elements, it is natural to introduce the following notation.

A1.2.10 Definition. If a set S has cardinality \aleph , then the cardinality of $\mathcal{P}(S)$ is denoted by 2^\aleph .

Thus we can rewrite (*) above as:

$$(**) \quad \aleph_0 < 2^{\aleph_0} < 2^{2^{\aleph_0}} < 2^{2^{2^{\aleph_0}}} < \dots$$

When we look at this sequence of cardinal numbers there are a number of questions which should come to mind including:

- (1) Is \aleph_0 the smallest infinite cardinal number?

- (2) Is \mathfrak{c} equal to one of the cardinal numbers on this list?
 (3) Are there any cardinal numbers strictly between \aleph_0 and 2^{\aleph_0} ?

These questions, especially (1) and (3), are not easily answered. Indeed they require a careful look at the axioms of set theory. It is not possible in this Appendix to discuss seriously the axioms of set theory. Nevertheless we will touch upon the above questions later in the appendix.

We conclude this section by identifying the cardinalities of a few more familiar sets.

A1.2.11 Lemma. Let a and b be real numbers with $a < b$. Then

- (i) $[0, 1] \sim [a, b]$;
- (ii) $(0, 1) \sim (a, b)$;
- (iii) $(0, 1) \sim (1, \infty)$;
- (iv) $(-\infty, -1) \sim (-2, -1)$;
- (v) $(1, \infty) \sim (1, 2)$;
- (vi) $\mathbb{R} \sim (-2, 2)$;
- (vii) $\mathbb{R} \sim (a, b)$.

Outline Proof. (i) is proved by observing that $f(x) = a + bx$ defines a one-to-one function of $[0, 1]$ onto $[a, b]$. (ii) and (iii) are similarly proved by finding suitable functions. (iv) is proved using (iii) and (ii). (v) follows from (iv). (vi) follows from (iv) and (v) by observing that \mathbb{R} is the union of the pairwise disjoint sets $(-\infty, -1)$, $[-1, 1]$ and $(1, \infty)$. (vii) follows from (vi) and (ii). \square .

A1.2.12 Proposition. Let a and b be real numbers with $a < b$. If S is any subset of \mathbb{R} such that $(a, b) \subseteq S$, then $\text{card } S = \mathfrak{c}$. In particular, $\text{card } (a, b) = \text{card } [a, b] = \mathfrak{c}$.

Proof. Using Lemma A1.2.11 observe that

$$\text{card } \mathbb{R} = \text{card } (a, b) \leq \text{card } [a, b] \leq \text{card } \mathbb{R}.$$

So $\text{card } (a, b) = \text{card } [a, b] = \text{card } \mathbb{R} = \mathfrak{c}$. □

A1.2.13 Proposition. If \mathbb{R}^2 is the set of points in the Euclidean plane, then $\text{card } (\mathbb{R}^2) = \mathfrak{c}$.

Outline Proof. By Proposition A1.2.12, \mathbb{R} is equipotent to the half-open interval $[0, 1)$ and it is easily shown that it suffices to prove that $[0, 1) \times [0, 1) \sim [0, 1)$.

Define $f : [0, 1) \rightarrow [0, 1) \times [0, 1)$ by $f(x)$ is the point $\langle x, 0 \rangle$. Then f is a one-to-one mapping of $[0, 1)$ into $[0, 1) \times [0, 1)$ and so $\mathfrak{c} = \text{card } [0, 1) \leq \text{card } [0, 1) \times [0, 1)$.

By the Cantor-Schröder-Bernstein Theorem, it suffices then to find a one-to-one function g of $[0, 1) \times [0, 1)$ into $[0, 1)$. Define

$$g(\langle 0.a_1a_2 \dots a_n \dots, 0.b_1b_2 \dots b_n \dots \rangle) = 0.a_1b_1a_2b_2 \dots a_nb_n \dots$$

Clearly g is well-defined (as each real number in $[0, 1)$ has a unique decimal representation that does not end in $99 \dots 9 \dots$) and is one-to-one, which completes the proof. □

A1.3 Cardinal Arithmetic

We begin with a definition of addition of cardinal numbers. Of course, when the cardinal numbers are finite, this definition must agree with addition of finite numbers.

A1.3.1 Definition. Let α and β be any cardinal numbers and select disjoint sets A and B such that $\text{card } A = \alpha$ and $\text{card } B = \beta$. Then the **sum of the cardinal numbers α and β** is denoted by $\alpha + \beta$ and is equal to $\text{card } (A \cup B)$.

A1.3.2 Remark. Before knowing that the above definition makes sense and in particular does not depend on the choice of the sets A and B , it is necessary to verify that if A_1 and B_1 are disjoint sets and A and B are disjoint sets such that $\text{card } A = \text{card } A_1$ and $\text{card } B = \text{card } B_1$, then $A \cup B \sim A_1 \cup B_1$; that is, $\text{card}(A \cup B) = \text{card}(A_1 \cup B_1)$. This is a straightforward task and so is left as an exercise. \square

A1.3.3 Proposition. For any cardinal numbers α , β and γ :

- (i) $\alpha + \beta = \beta + \alpha$;
- (ii) $\alpha + (\beta + \gamma) = (\alpha + \beta) + \gamma$;
- (iii) $\alpha + 0 = \alpha$;
- (iv) If $\alpha \leq \beta$ then $\alpha + \gamma \leq \beta + \gamma$.

Proof. Exercise \square

A1.3.4 Proposition.

- (i) $\aleph_0 + \aleph_0 = \aleph_0$;
- (ii) $\mathfrak{c} + \aleph_0 = \mathfrak{c}$;
- (iii) $\mathfrak{c} + \mathfrak{c} = \mathfrak{c}$;
- (iv) For any finite cardinal n , $n + \aleph_0 = \aleph_0$ and $n + \mathfrak{c} = \mathfrak{c}$.

Proof.

- (i) The listing $1, -1, 2, -2, \dots, n, -n, \dots$ shows that the union of the two countably infinite sets \mathbb{N} and the set of negative integers is a countably infinite set.
- (ii) Noting that $[-2, -1] \cup \mathbb{N} \subset \mathbb{R}$, we see that $\text{card}[-2, -1] + \text{card } \mathbb{N} \leq \text{card } \mathbb{R} = \mathfrak{c}$. So $\mathfrak{c} = \text{card}[-2, -1] \leq \text{card}([-2, -1] \cup \mathbb{N}) = \text{card}[-2, -1] + \text{card } \mathbb{N} = \mathfrak{c} + \aleph_0 \leq \mathfrak{c}$.
- (iii) Note that $\mathfrak{c} \leq \mathfrak{c} + \mathfrak{c} = \text{card}((0, 1) \cup (1, 2)) \leq \text{card } \mathbb{R} = \mathfrak{c}$ from which the required result is immediate.
- (iv) Observe that $\aleph_0 \leq n + \aleph_0 \leq \aleph_0 + \aleph_0 = \aleph_0$ and $\mathfrak{c} \leq n + \mathfrak{c} \leq \mathfrak{c} + \mathfrak{c} = \mathfrak{c}$, from which the results follow. \square

Next we define multiplication of cardinal numbers.

A1.3.5 Definition. Let α and β be any cardinal numbers and select disjoint sets A and B such that $\text{card } A = \alpha$ and $\text{card } B = \beta$. Then the **product of the cardinal numbers α and β** is denoted by $\alpha\beta$ and is equal to $\text{card}(A \times B)$.

As in the case of addition of cardinal numbers, it is necessary, but routine, to check in Definition A1.3.5 that $\alpha\beta$ does not depend on the specific choice of the sets A and B .

A1.3.6 Proposition. For any cardinal numbers α , β and γ

- (i) $\alpha\beta = \beta\alpha$;
- (ii) $\alpha(\beta\gamma) = (\alpha\beta)\gamma$;
- (iii) $1.\alpha = \alpha$;
- (iv) $0.\alpha = 0$;
- (v) $\alpha(\beta + \gamma) = \alpha\beta + \alpha\gamma$;
- (vi) For any finite cardinal n , $n\alpha = \alpha + \alpha + \dots + \alpha$ (n -terms);
- (v1i) If $\alpha \leq \beta$ then $\alpha\gamma \leq \beta\gamma$.

Proof. Exercise □

A1.3.7 Proposition.

- (i) $\aleph_0 \aleph_0 = \aleph_0$;
- (ii) $\mathfrak{c} \mathfrak{c} = \mathfrak{c}$;
- (iii) $\mathfrak{c} \aleph_0 = \mathfrak{c}$;
- (iv) For any finite cardinal n , $n \aleph_0 = \aleph_0$ and $n \mathfrak{c} = \mathfrak{c}$.

Outline Proof. (i) follows from Proposition 1.1.16, while (ii) follows from Proposition A1.2.13. To see (iii), observe that $\mathfrak{c} = \mathfrak{c}.1 \leq \mathfrak{c} \aleph_0 \leq \mathfrak{c} \mathfrak{c} = \mathfrak{c}$. The proof of (iv) is also straightforward. □

The next step in the arithmetic of cardinal numbers is to define exponentiation of cardinal numbers; that is, if α and β are cardinal numbers then we wish to define α^β .

A1.3.8 Definitions. Let α and β be cardinal numbers and A and B sets such that $\text{card } A = \alpha$ and $\text{card } B = \beta$. The set of all functions f of B into A is denoted by A^B . Further, α^β is defined to be $\text{card } A^B$.

Once again we need to check that the definition makes sense, that is that α^β does not depend on the choice of the sets A and B . We also check that if n and m are finite cardinal numbers, A is a set with n elements and B is a set with m elements, then there are precisely n^m distinct functions from B into A .

We also need to address one more concern: If α is a cardinal number and A is a set such that $\text{card } A = \alpha$, then we have two different definitions of 2^α . The above definition has 2^α as the cardinality of the set of all functions of A into the two point set $\{0, 1\}$. On the other hand, Definition A1.2.10 defines 2^α to be $\text{card } (\mathcal{P}(A))$. It suffices to find a bijection θ of $\{0, 1\}^A$ onto $\mathcal{P}(A)$. Let $f \in \{0, 1\}^A$. Then $f: A \rightarrow \{0, 1\}$. Define $\theta(f) = f^{-1}(1)$. The task of verifying that θ is a bijection is left as an exercise.

A1.3.9 Proposition. For any cardinal numbers α , β and γ :

- (i) $\alpha^{\beta+\gamma} = \alpha^\beta \alpha^\gamma$;
- (ii) $(\alpha\beta)^\gamma = \alpha^\gamma \beta^\gamma$;
- (iii) $(\alpha^\beta)^\gamma = \alpha^{(\beta\gamma)}$;
- (iv) $\alpha \leq \beta$ implies $\alpha^\gamma \leq \beta^\gamma$;
- (v) $\alpha \leq \beta$ implies $\gamma^\alpha \leq \gamma^\beta$.

Proof. Exercise □

After Definition A1.2.10 we asked three questions. We are now in a position to answer the second of these questions.

A1.3.10 Lemma. $\aleph_0^{\aleph_0} = \mathfrak{c}$.

Proof. Observe that $\text{card } \mathbb{N}^{\mathbb{N}} = \aleph_0^{\aleph_0}$ and $\text{card } (0, 1) = \mathfrak{c}$. As the function $f: (0, 1) \rightarrow \mathbb{N}^{\mathbb{N}}$ given by $f(0.a_1a_2 \dots a_n \dots) = \langle a_1, a_2, \dots, a_n, \dots \rangle$ is an injection, it follows that $\mathfrak{c} \leq \aleph_0^{\aleph_0}$.

By the Cantor-Schröder-Bernstein Theorem, to conclude the proof it suffices to find an injective map g of $\mathbb{N}^{\mathbb{N}}$ into $(0, 1)$. If $\langle a_1, a_2, \dots, a_n, \dots \rangle$ is any element of $\mathbb{N}^{\mathbb{N}}$, then each $a_i \in \mathbb{N}$ and so we can write

$a_i = \dots a_{in} a_{i(n-1)} \dots a_{i2} a_{i1}$, where for some $M_i \in \mathbb{N}$, $a_{in} = 0$, for all $n > M_i$ [For example $187 = \dots 00 \dots 0187$ and so if $a_i = 187$ then $a_{i1} = 7$, $a_{i2} = 8$, $a_{i3} = 1$ and $a_{in} = 0$, for $n > M_i = 3$.]

Then define the map g by

$$g(\langle a_1, a_2, \dots, a_n, \dots \rangle) = 0.a_{11}a_{12}a_{21}a_{13}a_{22}a_{31}a_{14}a_{23}a_{32}a_{41}a_{15}a_{24}a_{33}a_{42}a_{51}a_{16} \dots$$

(Compare this with the proof of Lemma A1.1.13.)

Clearly g is an injection, which completes the proof. □

We now state a beautiful result, first proved by Georg Cantor.

A1.3.11 Theorem. $2^{\aleph_0} = \mathfrak{c}$.

Proof. Firstly observe that $2^{\aleph_0} \leq \aleph_0^{\aleph_0} = \mathfrak{c}$, by Lemma A1.3.10. So we have to verify that $\mathfrak{c} \leq 2^{\aleph_0}$. To do this it suffices to find an injective map f of the set $[0, 1)$ into $\{0, 1\}^{\mathbb{N}}$. Each element x of $[0, 1)$ has a binary representation $x = 0.x_1x_2 \dots x_n \dots$, with each x_i equal to 0 or 1. The binary representation is unique except for representations ending in a string of 1s; for example,

$$1/4 = 0.0100 \dots 0 \dots = 0.0011 \dots 1 \dots$$

Providing that in all such cases we choose the representation with a string of zeros rather than a string of 1s, the representation of numbers in $[0, 1)$ is unique. We define the function $f: [0, 1) \rightarrow \{0, 1\}^{\mathbb{N}}$ which maps $x \in [0, 1)$ to the function $f(x): \mathbb{N} \rightarrow \{0, 1\}$ given by $f(x)(n) = x_n$, $n \in \mathbb{N}$. To see that f is injective, consider any x and y in $[0, 1)$ with $x \neq y$. Then $x_m \neq y_m$, for some $m \in \mathbb{N}$. So $f(x)(m) = x_m \neq y_m = f(y)(m)$. Hence the two functions $f(x): \mathbb{N} \rightarrow \{0, 1\}$ and $f(y): \mathbb{N} \rightarrow \{0, 1\}$ are not equal. As x and y were arbitrary (unequal) elements of $[0, 1)$, it follows that f is indeed injective, as required. □

A1.3.12 Corollary. If α is a cardinal number such that $2 \leq \alpha \leq \mathfrak{c}$, then $\alpha^{\aleph_0} = \mathfrak{c}$.

Proof. Observe that $\mathfrak{c} = 2^{\aleph_0} \leq \alpha^{\aleph_0} \leq \mathfrak{c}^{\aleph_0} = (2^{\aleph_0})^{\aleph_0} = 2^{\aleph_0 \cdot \aleph_0} = 2^{\aleph_0} = \mathfrak{c}$.

□

Appendix 2: Topology Personalities

The source for material extracted in this appendix is primarily *The MacTutor History of Mathematics Archive* [206] and Bourbaki [30]. In fairness all of the material in this section should be treated as being essentially direct quotes from these sources, though I have occasionally changed the words slightly, and included here only the material that I consider pertinent to this book.

René Louis Baire

René Louis Baire was born in Paris, France in 1874. In 1905 he was appointed to the Faculty of Science at Dijon and in 1907 was promoted to Professor of Analysis. He retired in 1925 after many years of illness, and died in 1932. Reports on his teaching vary, perhaps according to his health: “Some described his lectures as very clear, but others claimed that what he taught was so difficult that it was beyond human ability to understand.”

Stefan Banach

Stefan Banach was born in Ostrowsko, Austria-Hungary – now Poland – in 1892. He lectured in mathematics at Lvov Technical University from 1920 where he completed his doctorate which is said to mark the birth of functional analysis. In his dissertation, written in 1920, he defined axiomatically what today is called a Banach space. The name ‘Banach space’ was coined by Fréchet. In 1924 Banach was promoted to full Professor. As well as continuing to produce a stream of important papers, he wrote textbooks in arithmetic, geometry and algebra for high school. Banach’s Open Mapping Theorem of 1929 uses set-theoretic concepts which were introduced by Baire in his 1899 dissertation. The Banach-Tarski paradox appeared in a joint paper of the two mathematicians (Banach and Alfred Tarski) in 1926 in *Fundamenta Mathematicae*

entitled *Sur la décomposition des ensembles de points en partiens respectivement congruent*. The puzzling paradox shows that a ball can be divided into subsets which can be fitted together to make two balls each identical to the first. The Axiom of Choice is needed to define the decomposition and the fact that it is able to give such a non-intuitive result has made some mathematicians question the use of the Axiom. The Banach-Tarski paradox was a major contribution to the work being done on axiomatic set theory around this period. In 1929, together with Hugo Dyonizy Steinhaus, he started a new journal *Studia Mathematica* and Banach and Steinhaus became the first editors. The editorial policy was . . . to focus on research in functional analysis and related topics. The way that Banach worked was unconventional. He liked to do mathematical research with his colleagues in the cafés of Lvov. Stanislaw Ulam recalls frequent sessions in the Scottish Café (cf. Mauldin [151]): “It was difficult to outlast or outdrink Banach during these sessions. We discussed problems proposed right there, often with no solution evident even after several hours of thinking. The next day Banach was likely to appear with several small sheets of paper containing outlines of proofs he had completed.” In 1939, just before the start of World War II, Banach was elected President of the Polish Mathematical Society. The Nazi occupation of Lvov in June 1941 meant that Banach lived under very difficult conditions. Towards the end of 1941 Banach worked feeding lice in a German institute dealing with infectious diseases. Feeding lice was to be his life during the remainder of the Nazi occupation of Lvov up to July 1944. Banach died in 1945.

Luitzen Egbertus Jan Brouwer

Luitzen Egbertus Jan Brouwer was born in 1881 in Rotterdam, The Netherlands. While an undergraduate at the University of Amsterdam he proved original results on continuous motions in four dimensional space. He obtained his Master’s degree in 1904. Brouwer’s doctoral dissertation, published in 1907, made a major contribution to the ongoing debate between Bertrand Russell and Jules Henri Poincaré on the logical foundations of mathematics. Brouwer quickly found that his philosophical ideas sparked controversy. Brouwer put a very large effort into studying various problems which he attacked because they appeared on David Hilbert’s list of problems proposed at the Paris International Congress of Mathematicians in 1900. In particular Brouwer attacked Hilbert’s fifth problem concerning the theory of Lie groups. He addressed the International Congress of Mathematicians in Rome in 1908 on the topological foundations of Lie groups. Brouwer was elected to the Royal Academy of Sciences in 1912 and, in the same year, was

appointed extraordinary Professor of set theory, function theory and axiomatics at the University of Amsterdam; he would hold the post until he retired in 1951. Bartel Leendert van der Waerden, who studied at Amsterdam from 1919 to 1923, wrote about Brouwer as a lecturer: *Brouwer came [to the university] to give his courses but lived in Laren. He came only once a week. In general that would have not been permitted - he should have lived in Amsterdam - but for him an exception was made. ... I once interrupted him during a lecture to ask a question. Before the next week's lesson, his assistant came to me to say that Brouwer did not want questions put to him in class. He just did not want them, he was always looking at the blackboard, never towards the students.* Even though his most important research contributions were in topology, Brouwer never gave courses on topology, but always on – and only on – the foundations of intuitionism. It seemed that he was no longer convinced of his results in topology because they were not correct from the point of view of intuitionism, and he judged everything he had done before, his greatest output, false according to his philosophy. As is mentioned in this quotation, Brouwer was a major contributor to the theory of topology and he is considered by many to be its founder. He did almost all his work in topology early in his career between 1909 and 1913. He discovered characterisations of topological mappings of the Cartesian plane and a number of fixed point theorems. His first fixed point theorem, which showed that an orientation preserving continuous one-one mapping of the sphere to itself always fixes at least one point, came out of his research on Hilbert's fifth problem. Originally proved for a 2-dimensional sphere, Brouwer later generalised the result to spheres in n dimensions. Another result of exceptional importance was proving the invariance of topological dimension. As well as proving theorems of major importance in topology, Brouwer also developed methods which have become standard tools in the subject. In particular he used simplicial approximation, which approximated continuous mappings by piecewise linear ones. He also introduced the idea of the degree of a mapping, generalised the Jordan curve theorem to n -dimensional space, and defined topological spaces in 1913. Van der Waerden, in the above quote, said that Brouwer would not lecture on his own topological results since they did not fit with mathematical intuitionism. In fact Brouwer is best known to many mathematicians as the founder of the doctrine of mathematical intuitionism, which views mathematics as the formulation of mental constructions that are governed by self-evident laws. His doctrine differed substantially from the formalism of Hilbert and the logicism of Russell. His doctoral thesis in 1907 attacked the logical foundations of mathematics and marks the beginning of the Intuitionist School. In his 1908 paper *The Unreliability of the Logical Principles* Brouwer rejected in mathematical proofs the Principle of the Excluded Middle, which states that any mathematical statement is either true

or false. In 1918 he published a set theory developed without using the Principle of the Excluded Middle. He was made Knight in the Order of the Dutch Lion in 1932. He was active setting up a new journal and he became a founding editor of *Compositio Mathematica* which began publication in 1934. During World War II Brouwer was active in helping the Dutch resistance, and in particular he supported Jewish students during this difficult period. After retiring in 1951, Brouwer lectured in South Africa in 1952, and the United States and Canada in 1953. In 1962, despite being well into his 80s, he was offered a post in Montana. He died in 1966 in Blaricum, The Netherlands as the result of a traffic accident.

Maurice Fréchet

Maurice Fréchet was born in France in 1878 and introduced the notions of metric space and compactness (see Chapter 7) in his dissertation in 1906. He held positions at a number of universities including the University of Paris from 1928–1948. His research includes important contributions to topology, probability, and statistics. He died in 1973.

Felix Hausdorff

One of the outstanding mathematicians of the first half of the twentieth century was **Felix Hausdorff**. He did groundbreaking work in topology, metric spaces, functional analysis, Lie algebras and set theory. He was born in Breslau, Germany – now Wrocław, Poland – in 1868. He graduated from, and worked at, University of Leipzig until 1910 when he accepted a Chair at the University of Bonn. In 1935, as a Jew, he was forced to leave his academic position there by the Nazi Nuremberg Laws. He continued to do research in mathematics for several years, but could publish his results only outside Germany. In 1942 he was scheduled to go to an internment camp, but instead he and his wife and sister committed suicide.

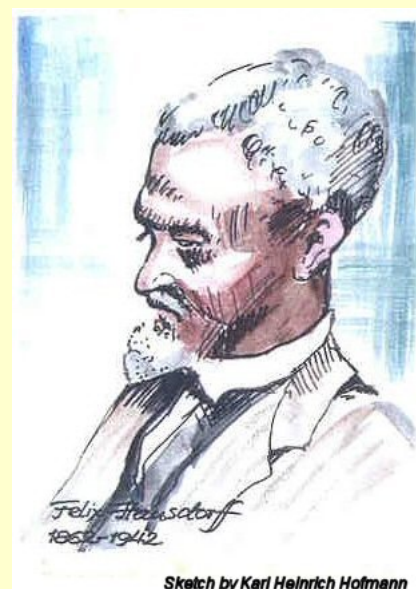

Wacław Sierpiński

Wacław Sierpiński was born in 1882 in Warsaw, Russian Empire – now Poland. Fifty years after he graduated from the University of Warsaw, Sierpiński looked back at the problems that he had as a Pole taking his degree at the time of the Russian occupation: . . . *we had to attend a yearly lecture on the Russian language. . . . Each of the students made it a point of honour to have the worst results in that subject. . . . I did not answer a single question . . . and I got an unsatisfactory mark. . . . I passed all my examinations, then the lector suggested I should take a repeat examination, otherwise I would not be able to obtain the degree of a candidate for mathematical science. . . . I refused him saying that this would be the first case at our University that someone having excellent marks in all subjects, having the dissertation accepted and a gold medal, would not obtain the degree of a candidate for mathematical science, but a lower degree, the degree of a 'real student' (strangely that was what the lower degree was called) because of one lower mark in the Russian language. Sierpiński was lucky for the lector changed the mark on his Russian language course to 'good' so that he could take his degree.* Sierpiński graduated in 1904 and worked as a school teacher of mathematics and physics in a girls' school. However when the school closed because of a strike, Sierpiński went to Kraków to study for his doctorate. At the Jagiellonian University in Kraków he received his doctorate and was appointed to the University of Lvov in 1908. In 1907 Sierpiński for the first time became interested in set theory. He happened across a theorem which stated that points in the plane could be specified with a single coordinate. He wrote to Tadeusz Banachiewicz asking him how such a result was possible. He received a one word reply (Georg) 'Cantor'. Sierpiński began to study set theory and in 1909 he gave the first ever lecture course devoted entirely to set theory. During the years 1908 to 1914, when he taught at the University of Lvov, he published three books in addition to many research papers. These books were *The theory of Irrational numbers* (1910), *Outline of Set Theory* (1912) and *The Theory of Numbers* (1912). When World War I began in 1914, Sierpiński and his family happened to be in Russia. Sierpiński was interned in Viatka. However Dimitri Feddovich Egorov and Nikolai Nikolaevich Luzin heard that he had been interned and arranged for him to be allowed to go to Moscow. Sierpiński spent the rest of the war years in Moscow working with Luzin. Together they began the study of analytic sets. When World War I ended in 1918, Sierpiński returned to Lvov. However shortly after he was accepted a post at the University of Warsaw. In 1919 he was promoted to Professor spent the rest of his life there. In 1920 Sierpiński, together with his former student Stefan Mazurkiewicz, founded the important mathematics journal *Fundamenta Mathematica*. Sierpiński

edited the journal which specialised in papers on set theory. From this period Sierpiński worked mostly in set theory but also on point set topology and functions of a real variable. In set theory he made important contributions to the axiom of choice and to the continuum hypothesis. He studied the Sierpiński curve which describes a closed path which contains every interior point of a square – a “space-filling curve”. The length of the curve is infinity, while the area enclosed by it is $5/12$ that of the square. Two fractals – Sierpiński triangle and Sierpiński carpet – are named after him. Sierpiński continued to collaborate with Luzin on investigations of analytic and projective sets. Sierpiński was also highly involved with the development of mathematics in Poland. In 1921 He had been honoured with election to the Polish Academy was made Dean of the faculty at the University of Warsaw. In 1928 he became Vice-Chairman of the Warsaw Scientific Society and, was elected Chairman of the Polish Mathematical Society. In 1939 life in Warsaw changed dramatically with the advent of World War II. Sierpiński continued working in the ‘Underground Warsaw University’ while his official job was a clerk in the council offices in Warsaw. His publications continued since he managed to send papers to Italy. Each of these papers ended with the words: *The proofs of these theorems will appear in the publication of Fundamenta Mathematica* which everyone understood meant ‘Poland will survive’. After the uprising of 1944 the Nazis burned his house destroying his library and personal letters. Sierpiński spoke of the tragic events of the war during a lecture he gave in 1945. He spoke of his students who had died in the war: *In July 1941 one of my oldest students Stanislaw Ruziewicz was murdered. He was a retired professor of Jan Kazimierz University in Lvov . . . an outstanding mathematician and an excellent teacher. In 1943 one of my most distinguished students Stanislaw Saks was murdered. He was an Assistant Professor at Warsaw University, one of the leading experts in the world in the theory of the integral. . . In 1942 another student of mine was Adolf Lindenbaum was murdered. He was an Assistant Professor at Warsaw University and a distinguished author of works on set theory.* After listing colleagues who were murdered in the war such as Juliusz Pawel Schauder and others who died as a result of the war such as Samuel Dickstein and Stanislaw Zaremba, Sierpiński continued: *Thus more than half of the mathematicians who lectured in our academic schools were killed. It was a great loss for Polish mathematics which was developing favourably in some fields such as set theory and topology . . . In addition to the lamented personal losses Polish mathematics suffered because of German barbarity during the war, it also suffered material losses. They burned down Warsaw University Library which contained several thousand volumes, magazines, mathematical books and thousands of reprints of mathematical works by different authors. Nearly all the editions of Fundamenta Mathematica (32 volumes) and ten volumes of*

Mathematical Monograph were completely burned. Private libraries of all the four Professors of mathematics from Warsaw University and also quite a number of manuscripts of their works and handbooks written during the war were burnt too. Sierpiński was the author of the incredible number of 724 papers and 50 books. He retired in 1960 as Professor at the University of Warsaw but he continued to give a seminar on the theory of numbers at the Polish Academy of Sciences up to 1967. He also continued his editorial work, as Editor-in-Chief of *Acta Arithmetica* which he began in 1958, and as an editorial board member of *Rendiconti dei Circolo Matimatico di Palermo*, *Compositio Mathematica* and *Zentralblatt für Mathematik*. Andrzej Rotkiewicz, who was a student of Sierpiński's wrote: *Sierpiński had exceptionally good health and a cheerful nature. . . . He could work under any conditions.* Sierpiński died in 1969.

Appendix 3: Chaos Theory and Dynamical Systems

Introduction

In this Appendix we give but a taste of dynamical systems and chaos theory. Most of the material is covered by way of exercises. Some parts of this Appendix require some knowledge of calculus. If you have not studied calculus you can skip this Appendix altogether or merely skim through it to get a flavour.

A3.1 Iterates and Orbits

A3.1.1 Definition. Let S be a set and f a function mapping the set S into itself; that is, $f: S \rightarrow S$. The functions $f^1, f^2, f^3, \dots, f^n, \dots$ are inductively defined as follows:

$f^1: S \rightarrow S$ is given by $f^1(x) = f(x)$; that is $f^1 = f$;

$f^2: S \rightarrow S$ is given by $f^2(x) = f(f(x))$; that is $f^2 = f \circ f$;

$f^3: S \rightarrow S$ is given by $f^3(x) = f(f(f(x)))$; that is, $f^3 = f \circ f \circ f = f \circ f^2$;

and if f^{n-1} is known then

$f^n: S \rightarrow S$ is defined by $f^n(x) = f(f^{n-1}(x))$; that is, $f^n = f \circ f^{n-1}$.

Each of the the functions $f^1, f^2, f^3, \dots, f^n, \dots$ is said to be an **iterate** of the function f .

Note that $f^{n+m} = f^n \circ f^m$, for $n, m \in \mathbb{N}$.

A3.1.2 Definitions. Let f be a function mapping the set S into itself. If $x_0 \in S$, then the sequence $x_0, f^1(x_0), f^2(x_0), \dots, f^n(x_0), \dots$ is called the **orbit** of the point x_0 . The point x_0 is called the **seed** of the orbit.

There are several possibilities for orbits, but the most important kind is a fixed point.

A3.1.3 Definition. Let f be a mapping of a set S into itself. A point $a \in S$ is said to be a **fixed point** of f if $f(a) = a$.

A3.1.4 Example. Graphically, we can find all fixed points of a function $f: \mathbb{R} \rightarrow \mathbb{R}$, simply by sketching the curve $y = f(x)$ and seeing where it intersects the line $y = x$. At points of intersection, and only for these points, do we have $f(x) = x$.

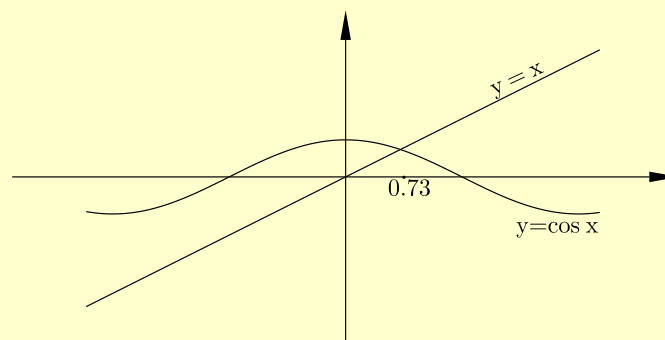

The fixed point of $f(x) = \cos x$ is $x = .739085133$ approximately

□

A3.1.5 Example.

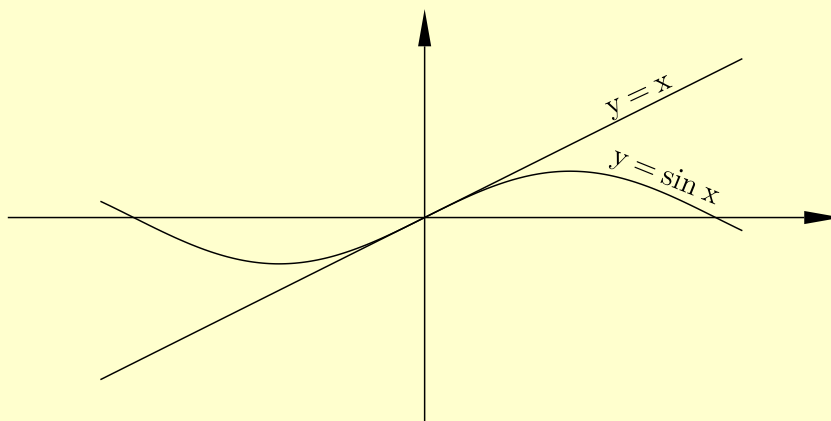

The fixed point of $f(x) = \sin x$ is $x = 0$

□

Exercises A3.1

1. Let the functions $f: \mathbb{R} \rightarrow \mathbb{R}$, $g: \mathbb{R} \rightarrow \mathbb{R}$ and $h: \mathbb{R} \rightarrow \mathbb{R}$ be given by $f(x) = x(1 - x)$, $g(x) = x \sin x$, and $h(x) = x^2 - 2$, for all $x \in \mathbb{R}$.
 - (a) Evaluate $f^1(x)$ and $f^2(x)$.
 - (b) Evaluate $g^2(x)$ and $g^2(1)$.
 - (c) Evaluate $h^2(x)$ and $h^3(x)$.

2. (a) If $C(x) = \cos(x)$, use your calculator [in radians to 4 decimal places] to compute $C^{10}(123)$, $C^{20}(123)$, $C^{30}(123)$, $C^{40}(123)$, $C^{50}(123)$, $C^{60}(123)$, $C^{70}(123)$, $C^{80}(123)$, $C^{90}(123)$, $C^{100}(123)$, $C^{100}(500)$ and $C^{100}(1)$. What do you notice?
- (b) If $S(x) = \sin(x)$, use your calculator to compute $S^{10}(123)$, $S^{20}(123)$, $S^{30}(123)$, $S^{40}(123)$, $S^{50}(123)$, $S^{60}(123)$, $S^{70}(123)$, $S^{80}(123)$, $S^{90}(123)$, $S^{100}(123)$. What do you notice?

3. Let the function $h: \mathbb{R} \rightarrow \mathbb{R}$ be given by $h(x) = x^2$, for all $x \in \mathbb{R}$. Calculate the orbits for the function h of each of the following seeds: 0, 1, -1, 0.5, 0.25.

4. Find all the fixed points of the function f in Exercise 1 above.

5. Let $f: \mathbb{R} \rightarrow \mathbb{R}$ be given by $f(x) = x^3 - 3x$. Find all the fixed points of the function f .

A3.2 Fixed Points and Periodic Points

A3.2.6 Definition. Let f be a mapping of a set S into itself. A point $a \in S$ is said to be **eventually fixed** if a is not a fixed point, but some point on the orbit of a is a fixed point.

A3.2.1 Definitions. Let f be a function mapping the set S into itself. If $x \in S$, then the point $x \in S$ is said to be **periodic** if there exists a positive integer p such that $f^p(x) = x$. If m is the least $n \in \mathbb{N}$ such that $f^n(x) = x$, then m is called the **prime period** of x .

A3.2.2 Definition. Let f be a function mapping the set S into itself. Then the point $x_0 \in S$ is said to be **eventually periodic** if x_0 is not periodic itself, but some point in the orbit of x_0 is periodic.

A3.2.3 Remark. We have seen that points may be fixed, eventually fixed, periodic, or eventually periodic. However, it is important to realize that most points are not in any of these classes. □

Exercises A3.2

1. Verify that the point -1 is an eventually fixed point of $f(x) = x^2$.
2. Find the eventually fixed points of the function $f: \mathbb{R} \rightarrow \mathbb{R}$ given by $f(x) = |x|$.
3. If $f: \mathbb{R} \rightarrow \mathbb{R}$ is given by $f(x) = -\frac{3}{2}x^2 + \frac{5}{2}x + 1$, verify that $f(0) = 1$, $f(1) = 2$, and $f(2) = 0$, so that the orbit of 0 is $0, 1, 2, 0, 1, 2, \dots$. Hence 0 is a periodic point of prime period 3 .
4. Prove that if x is a periodic point of prime period m of the function $f: S \rightarrow S$, then the orbit of x has precisely m points.

[Hint: Firstly write down the orbit of the point x and then deduce that it has at most m points in it. Next suppose that there are fewer than m distinct points in the orbit of x and show that this leads to a contradiction to x having period m .]

5. Let $f: \mathbb{R} \rightarrow \mathbb{R}$ be given by $f(x) = x^2 - 1$. Verify that the points $\sqrt{2}$ and 1 are eventually periodic.
6. Consider the function $f: \mathbb{R} \rightarrow \mathbb{R}$ given by $f(x) = |1 - x|$.
 - (i) Find all of the fixed points of f .
 - (ii) If m is an odd integer, what can you say about the orbit of m ?
 - (iii) If m is an even integer, what can you say about the orbit of m ?

A3.3 Phase Portraits, Attracting and Repelling Fixed Points

We wish to study dynamical systems, that is processes in motion. Such processes include for example the motion of planets, but other systems to which this theory is applied include the weather and population growth. Some even feel the study of dynamical systems will help us to understand stock market movements.

A very good method for depicting all orbits of a dynamical system is the phase portrait of the system. This is a picture on the real line of the orbits.

In the phase portrait we represent fixed points by **solid dots** and the dynamics along orbits by **arrows**.

A3.3.1 Example. if $f(x) = x^3$, then the fixed points are 0, 1, and -1 . If $|x_0| < 1$ then the orbit of x_0 is a sequence which tends to 0; we write this $f^n(x_0) \rightarrow 0$. If $|x_0| > 1$, then the orbit is a sequence which diverges to ∞ ; that is, $f^n(x_0) \rightarrow \pm\infty$. The phase portrait is given below:

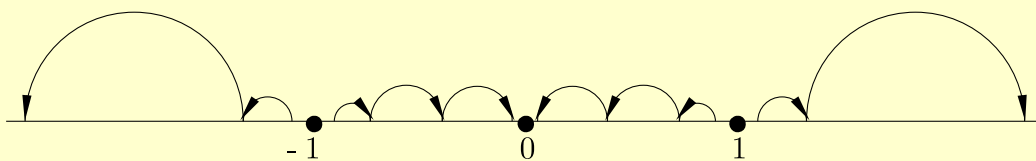

Phase portrait of $f(x) = x^3$

□

A3.3.2 Definition. Let a be a fixed point of the function $f: \mathbb{R} \rightarrow \mathbb{R}$. The point a is said to be an **attracting fixed point of f** if there is an open interval I containing a such that if $x \in I$, then $f^n(x) \rightarrow a$ as $n \rightarrow \infty$.

A3.3.3 Definition. Let a be a fixed point of the function $f: \mathbb{R} \rightarrow \mathbb{R}$. The point a is said to be a **repelling fixed point of f** if there is an open interval I containing a such that if $x \in I$ with $x \neq a$ then there is an integer n such that $f^n(x) \notin I$.

A3.3.4 Example. Observe that 0 is an attracting fixed point of $f(x) = x^3$, while -1 and 1 are repelling fixed points of this function. \square

A3.3.5 Definition. A fixed point which is neither repelling nor attracting is called a **neutral fixed point**.

Exercises A3.3

1. Verify that the picture below is a correct phase portrait of $f(x) = x^2$ and identify whether the fixed points are repelling, attracting or neutral.

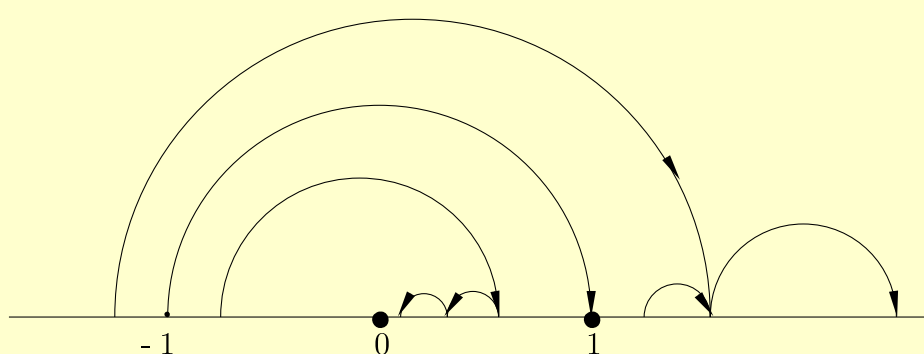

Phase portrait of $f(x) = x^2$

2. Do phase portraits for each of the following functions $f: \mathbb{R} \rightarrow \mathbb{R}$. Determine whether any fixed points are attracting, repelling or neutral.

(i) $f(x) = -x^3$.

(ii) $f(x) = 4x$.

(iii) $f(x) = x - x^2$.

(iv) $f(x) = \sin x$.

3. Let $D: [0, 1) \rightarrow \mathbb{R}$ be the **doubling function** defined by

$$D(x) = \begin{cases} 2x, & 0 \leq x < \frac{1}{2} \\ 2x - 1, & \frac{1}{2} \leq x < 1. \end{cases}$$

[We could define D more succinctly by $D(x) = 2x \pmod{1}$.]

- (i) Verify that the point $\frac{1}{99}$ is a periodic point and find its prime period.
- (ii) Explain why $\frac{1}{n}$ is either a periodic point or an eventually periodic point for each positive integer n .

- (iii) Explain why $\frac{1}{2^n}$ is eventually fixed, for every positive integer n .
- (iv) Write an explicit formula for $D^2(x)$ and $D^3(x)$, for $0 \leq x < 1$.
- (v) Find all fixed points of D^2 and D^3 .
4. Do a phase portrait of the function $f(x) = 2x(1 - x)$. [This is an example of a so-called **logistic function** which arises naturally in the study of population growth and ecology.]

A3.4 Graphical Analysis

A3.4.1 Remark. We have used phase portraits to determine whether a point x_0 is fixed, periodic, eventually periodic etc. This method is particularly useful when we are dealing with more than one dimension. But for functions $f: \mathbb{R} \rightarrow \mathbb{R}$, we can use **graphical analysis**. This is done as follows.

Given a function $f: \mathbb{R} \rightarrow \mathbb{R}$, we are asked to determine the nature of the point $x_0 \in \mathbb{R}$. What we do is find the orbits of points a near to x_0 . We begin by sketching the function f and superimposing on its graph the graph of the line $y = x$.

To find the orbit of the point a , plot the point (a, a) . Next draw a vertical line to meet the graph of f at the point $(a, f(a))$. Then draw a horizontal line to meet the line $y = x$ at the point $(f(a), f(a))$. Now draw a vertical line to meet the graph of f at the point $(f(a), f^2(a))$. Once again draw a horizontal line to meet the line $y = x$ at the point $(f^2(a), f^2(a))$. We continue this process and the points $a, f(a), f^2(a), f^3(a), \dots$ form the orbit of a . \square

A3.4.2 Example. We will now consider the function $f: \mathbb{R} \rightarrow \mathbb{R}$, given by $f(x) = x^4$. We sketch the curve $y = x^4$ and superimpose the line $y = x$. To find the fixed points we can solve $f(x) = x$; that is, solve $x^4 = x$.

It is readily seen that the fixed points are 0 and 1. We will consider points near each of these and do a graphical analysis, as described above, to find the orbits of points near 0 and near 1.

The analysis in the diagram below shows what happens to points near to 1.

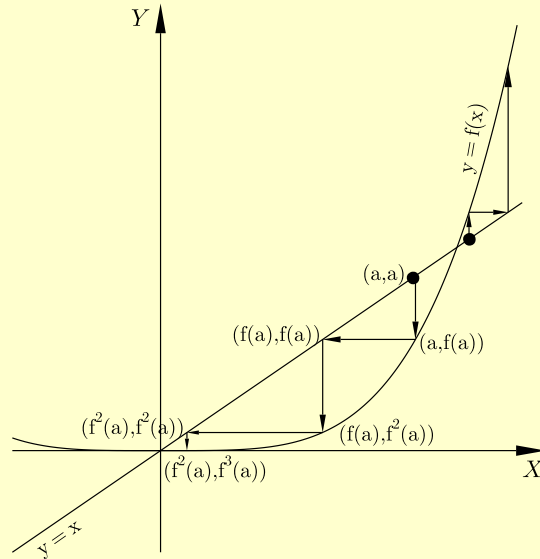

□

The next examples show graphical analyses of two more functions to indicate how different these can be for different functions. You will then get experience doing graphical analysis yourself.

A3.4.3 Example.

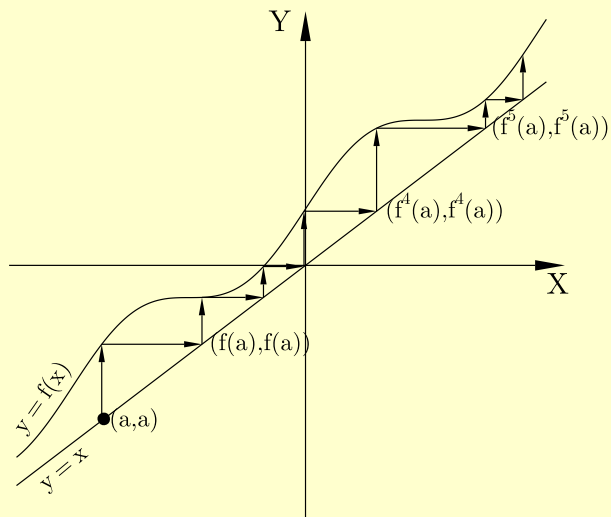

In the above figure $f(x) = \sin x + x + 2$.

□

A3.1.16 Example.

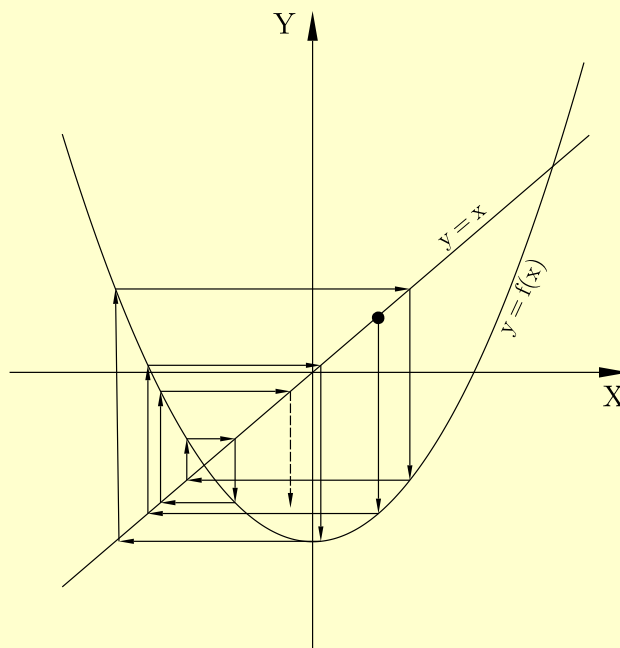

In the above figure $f(x) = x^2 - 1.5$.

Exercises A3.4

1. Determine by graphical analysis whether each fixed point of $f(x) = x^4$ is an attracting fixed point, a repelling fixed point, or a neutral fixed point.
2. Use graphical analysis to describe the orbits of the function $f(x) = 2x$ and to determine the type of fixed point it has.
3. Find the fixed points of the function $f(x) = \sqrt{x}$ and use graphical analysis to determine their nature (that is, whether they are attracting, repelling, or neutral fixed points).
4. Use graphical analysis to describe the fate of all orbits of the function $f(x) = x - x^2$.
5. Use graphical analysis to describe the fate of all orbits of the function $f(x) = e^x$.
6. Let $f(x) = |x - 2|$. Use graphical analysis to display a variety of orbits of f . It may help to use different colours; for example, one colour for periodic orbits, another colour for eventually periodic orbits and yet another for eventually fixed orbits.
7. Let $D : [0, 1) \rightarrow [0, 1)$ be the doubling function given by $D(x) = 2x \bmod(1)$.

(i) Prove that $x \in [0, 1)$ is a rational number if and only if x is either a periodic point or an eventually periodic point of D .

(ii) Verify that the set of all periodic points of D is

$$P = \bigcup_{n=1}^{\infty} \left\{ 0, \frac{1}{2^n - 1}, \frac{2}{2^n - 1}, \frac{3}{2^n - 1}, \dots, \frac{2^n - 2}{2^n - 1} \right\}.$$

[Hint. It may be helpful to write down a formula for D^n and to calculate the points of intersection of the graph of D^n with the line $y = x$.]

(iii) Verify that the set of periodic points of D is dense in $[0, 1)$. [We shall see that this is one of the two conditions required to show that the dynamical system $([0, 1), D)$ is chaotic.]

A3.5 Bifurcation

A3.5.1 Remark. It is natural to ask if every continuous function $f: S \rightarrow \mathbb{R}$ has a fixed point, where $S \subseteq \mathbb{R}$? The answer is easily seen to be **no**. For example, if $f: \mathbb{R} \rightarrow \mathbb{R}$ is given by $f(x) = x + 1$, then obviously there are no fixed points. Therefore it is remarkable that we can guarantee the existence of fixed points of **all** continuous functions of $[0, 1]$ into itself. More precisely, we have already seen and proved the following corollary:

5.2.11 Corollary. (Fixed Point Theorem) Let f be a continuous mapping of $[0, 1]$ into $[0, 1]$. Then there exists a $z \in [0, 1]$ such that $f(z) = z$.

Of course the above corollary does not help us to find the fixed point, rather it tells us only that at least one fixed point exists.

It would also be nice to have a simple way of establishing whether a particular fixed point is attracting, repelling, or neutral. For well-behaved functions Theorems A3.5.2 and A3.5.3 will be very useful in this regard. □

A3.5.2 Theorem. Let S be an interval in \mathbb{R} and a be a point in the interior of S . Further, let a be a fixed point of a function $f: S \rightarrow \mathbb{R}$. If f is differentiable at the point a and $|f'(a)| < 1$, then a is an attracting fixed point of f .

Proof. As $|f'(a)| < 1$, we have $|f'(a)| < k < 1$, where k is the positive real number given by $k = \frac{|f'(a)|+1}{2}$.

By definition, $f'(a) = \lim_{x \rightarrow a} \frac{f(x)-f(a)}{x-a}$. So for x "close enough" to a , we have $|\frac{f(x)-f(a)}{x-a}| \leq k$; more precisely, there exists an interval $I = [a - \delta, a + \delta]$, for some $\delta > 0$, such that $|\frac{f(x)-f(a)}{x-a}| \leq k$, for all $x \in I$ with $x \neq a$.

Since a is a fixed point, $f(a) = a$. So

$$|f(x) - a| \leq k|x - a|, \quad \text{for all } x \in I. \quad (1)$$

This implies that $f(x)$ is closer to a than x is, and so $f(x)$ is in I too. So we can repeat the same argument with $f(x)$ replacing x and obtain

$$|f^2(x) - a| \leq k|f(x) - a|, \quad \text{for all } x \in I. \quad (2)$$

From (1) and (2), we obtain

$$|f^2(x) - a| \leq k^2|x - a|, \quad \text{for all } x \in I. \quad (3)$$

Noting that $|k| < 1$ implies that $k^2 < 1$, we can repeat the argument again. By mathematical induction we obtain,

$$|f^n(x) - a| \leq k^n|x - a|, \quad \text{for all } x \in I \text{ and } n \in \mathbb{N}. \quad (4)$$

As $|k| < 1$, $\lim_{n \rightarrow \infty} k^n = 0$. By (4) this implies that $f^n(x) \rightarrow a$ as $n \rightarrow \infty$. And we have proved that a is an attracting fixed point. \square

The proof of Theorem A3.5.3 is analogous to that of Theorem A3.5.2 and so is left as an exercise.

A3.5.3 Theorem. Let S be an interval in \mathbb{R} and a an interior point of S . Further, let a be a fixed point of a function $f: S \rightarrow \mathbb{R}$. If f is differentiable at the point a and $|f'(a)| > 1$, then a is a repelling fixed point of f .

A3.5.4 Remark. It is important to note that Theorem A3.5.2 and Theorem A3.5.3 do not give necessary and sufficient conditions. Rather they say that if f' exists and $|f'(x)| < 1$ in an interval containing the fixed point a , then a is an attracting fixed point; and if $|f'(x)| > 1$ in an interval containing the fixed point a , then a is a repelling fixed point. If neither of these conditions is true we can say nothing! For example, it is possible that f is not differentiable at a but f still has an attracting fixed point at a . (This is the case, for example for $f(x) = \begin{cases} x^2 & \text{for } x \in \mathbb{Q} \\ -x^2 & \text{for } x \in \mathbb{R} \setminus \mathbb{Q}, \end{cases}$ which has 0 as an attracting fixed point.)

Even if f is differentiable at a , Theorems A3.1.17 and A3.1.18 tell us absolutely nothing if $f'(a) = 1$. Consider $f(x) = \sin x$. This function is differentiable at 0 with $f'(0) = \cos(0) = 1$. So Theorems A3.1.17 and A3.1.18 tell us nothing. However, 0 is an attracting fixed point of f . \square

A3.5.5 Remark. One of the most important family of functions in this theory is the family of **quadratic maps** $Q_c: \mathbb{R} \rightarrow \mathbb{R}$, where $c \in \mathbb{R}$, and $Q_c(x) = x^2 + c$. For each different value of c we get a different quadratic function. But the surprising feature is that the dynamics of Q_c changes as c changes. The following theorem indicates this. We leave the proof of the theorem as an exercise.

A3.5.6 Theorem. (The First Bifurcation Theorem) Let Q_c be the quadratic function for $c \in \mathbb{R}$.

- (i) If $c > \frac{1}{4}$, then all orbits tend to infinity; that is, for all $x \in \mathbb{R}$, $(Q_c)^n(x) \rightarrow \infty$ as $n \rightarrow \infty$.
- (ii) If $c = \frac{1}{4}$, then Q_c has precisely one fixed point at $x = \frac{1}{2}$ and this is a neutral fixed point.
- (iii) If $c < \frac{1}{4}$, then Q_c has two fixed points $a_+ = \frac{1}{2}(1 + \sqrt{1 - 4c})$ and $a_- = \frac{1}{2}(1 - \sqrt{1 - 4c})$.
 - (a) The point a_+ is always repelling.
 - (b) If $-\frac{3}{4} < c < \frac{1}{4}$, then a_- is attracting.
 - (c) If $c < -\frac{3}{4}$, then a_- is repelling.

A3.5.7 Remark. The term **bifurcation** means a division into two. We see in the above theorem that for $c > \frac{1}{4}$ there are no fixed points; for $c = \frac{1}{4}$ there is precisely one fixed point; but for $c < \frac{1}{4}$ this fixed point splits into two — one at a_+ and one at a_- . We will say more about bifurcation presently.

A3.5.8 Definition. Let f be a function mapping the set S into itself. If the point $x \in S$ has prime period m , then the orbit of x is $\{x, f(x), \dots, f^{m-1}(x)\}$ and the orbit is called an **m -cycle**.

A3.5.9 Definitions. Let a be a periodic point of a function $f: S \rightarrow S$ of prime period m , for some $m \in \mathbb{N}$. [So a is clearly a fixed point of $f^m: S \rightarrow S$.] Then a is said to be an **attracting periodic point** of f if it is an attracting fixed point of f^m . Similarly a is said to be a **repelling periodic point** of f if it is a repelling fixed point of f^m .

The following theorem is left as an exercise.

A3.5.10 Theorem. (The Second Bifurcation Theorem) Let Q_c be the quadratic function for $c \in \mathbb{R}$.

- (a) If $-\frac{3}{4} \leq c < \frac{1}{4}$, then Q_c has no 2-cycles.
- (b) If $-\frac{5}{4} < c < -\frac{3}{4}$, then Q_c has an attracting 2-cycle, $\{q_-, q_+\}$, where $q_+ = \frac{1}{2}(-1 + \sqrt{-4c - 3})$ and $q_- = \frac{1}{2}(-1 - \sqrt{-4c - 3})$.
- (c) If $c < -\frac{5}{4}$, then Q_c has a repelling 2-cycle $\{q_-, q_+\}$.

A3.5.11 Remark. In The Second Bifurcation Theorem we saw a new kind of bifurcation called a **period doubling bifurcation**. As c decreases below $-\frac{3}{4}$, two things happen: the fixed point a_- changes from attracting to repelling and a new 2-cycle, $\{q_-, q_+\}$ appears. Note that when $c = -\frac{3}{4}$, we have $q_- = q_+ = -\frac{1}{2} = a_-$. So these two new periodic points originated at a_- when $c = -\frac{3}{4}$.

We will have more to say about period doubling bifurcations when we consider one-parameter families of functions (such as $Q_c: \mathbb{R} \rightarrow \mathbb{R}$, which depends on the parameter c , and the logistic functions $f_\lambda(x) = \lambda x(1 - x)$, which depend on the parameter λ). \square

Exercises A3.5

1. Prove Theorem A3.5.3.
2. Using Theorems A3.5.2 and A3.5.3 determine the nature of the fixed points of each of the following functions:
 - (i) $f_1(x) = 3x$.
 - (ii) $f_2(x) = \frac{1}{4x}$.
 - (iii) $f_3(x) = x^3$.
3. Prove The First Bifurcation Theorem A3.5.6.

4. Let x be a periodic point of period 2 of the quadratic map Q_c . Prove that

(i) Prove that $x^4 + 2cx^2 - x + c^2 + c = 0$.

(ii) Why do the points $a_+ = \frac{1}{2}(1 + \sqrt{1 - 4c})$ and $a_- = \frac{1}{2}(1 - \sqrt{1 - 4c})$ satisfy the equation in (i)?

[Hint. Use The First Bifurcation Theorem.]

(iii) Using (ii), show that if x is a periodic point of prime period 2 of Q_c , then $x^2 + x + c + 1 = 0$.

(iv) Deduce that if x is a periodic point of prime period 2, then x is one of the points

$$q_+ = \frac{1}{2}(-1 + \sqrt{-4c - 3}) \text{ and } q_- = \frac{1}{2}(-1 - \sqrt{-4c - 3}).$$

(v) Deduce that Q_c has a 2-cycle if and only if $c < -\frac{3}{4}$. [Be careful to eliminate the case $c = -\frac{3}{4}$.]

(vi) Using Theorem A3.1.17 show that the quadratic function Q_c has q_- and q_+ as attracting periodic points if $|\frac{dQ_c^2(x)}{dx}| = |4x^3 + 4cx| < 1$ at $x = q_-$ and $x = q_+$.

(vii) Noting that q_- and q_+ both satisfy the equation $x^2 + x + c + 1 = 0$ (from (iii) and (iv) above), show that

$$4x^3 + 4cx = 4x(x^2 + c) = 4x(-1 - x) = 4(c + 1).$$

(viii) Using (vi), (vii), and (v) show that for $-\frac{5}{4} < c < -\frac{3}{4}$, q_+ and q_- are attracting periodic points of Q_c .

(ix) Similarly show that for $c < -\frac{5}{4}$, q_+ and q_- are repelling periodic points.

(x) Deduce the Second Bifurcation Theorem A3.5.10 from what has been proved above in this exercise.

A3.6 The Magic of Period 3: Period 3 Implies Chaos

A3.6.1 Remark. In 1964, the Soviet mathematician A.N. Sarkovskii published the paper (Sarkovskii [193]) in Russian in a Ukrainian journal. There he proved a remarkable theorem which went unnoticed. In 1975 James Yorke and T-Y. Li published the paper (Yorke and Li [225]) in the *American Mathematical Monthly*. Even though the term “chaos” had previously been used in scientific literature, it was this paper that initiated the popularisation of the term. The main result of the paper, The Period Three Theorem, is astonishing, but is a very special case of Sarkovskii’s Theorem, proved a decade earlier. The discussion here of The Period Three Theorem is based on the presentation by Robert L. Devaney in his book (Devaney [56]).

A3.6.2 Theorem. (The Period Three Theorem) Let $f: \mathbb{R} \rightarrow \mathbb{R}$ be a continuous function. If f has a periodic point of prime period 3, then for each $n \in \mathbb{N}$ it has a periodic point of prime period n .

Proof. Exercises A3.6 #1–4.. □

A3.6.3 Remark. The Period Three Theorem is remarkable. But as stated earlier, a much more general result is true. It is known as Sarkovskii’s Theorem. We shall not give a proof, but simply point out that the proof is of a similar nature to that above.

To state Sarkovskii’s Theorem we need to order the natural numbers in the following curious way known as **Sarkovskii’s ordering of the natural numbers**:

$$\begin{array}{c}
 3, 5, 7, 9, \dots \\
 2 \cdot 3, 2 \cdot 5, 2 \cdot 7, \dots \\
 2^2 \cdot 3, 2^2 \cdot 5, 2^2 \cdot 7, \dots \\
 2^3 \cdot 3, 2^3 \cdot 5, 2^3 \cdot 7, \dots \\
 \vdots \\
 \dots, 2^n, 2^{n-1}, \dots, 2^3, 2^2, 2^1, 1.
 \end{array}$$

A3.6.4 Theorem. (Sarkovskii's Theorem) Let $f: \mathbb{R} \rightarrow \mathbb{R}$ be a continuous function. If f has a periodic point of prime period n and n precedes k in Sarkovskii's ordering of the natural numbers, then f has a periodic point of prime period k .

A3.6.5 Remarks. (i) Firstly observe that as 3 appears first in Sarkovskii's ordering of the natural numbers, Sarkovskii's Theorem implies The Period Three Theorem.

(ii) Secondly note that as the numbers of the form 2^n constitute the tail of Sarkovskii's ordering of the natural numbers, it follows that if f has only a finite number of periodic points, then they must all be of the form 2^n .

(iii) Thirdly note that Sarkovskii's Theorem applies to continuous functions from \mathbb{R} into itself. If \mathbb{R} is replaced by other spaces the theorem may become false. However, \mathbb{R} can be replaced by any closed interval $[a, b]$. To see this let $f: [a, b] \rightarrow [a, b]$ be a continuous function. Then extend f to a continuous function $f': \mathbb{R} \rightarrow \mathbb{R}$ by defining $f'(x) = f(x)$, for $x \in [a, b]$; $f'(x) = f(a)$ if $x < a$; and $f'(x) = f(b)$, if $x > b$. Then the Theorem for f can be deduced from the Theorem for f' .

It is remarkable that the converse of Sarkovskii's Theorem is also true but we shall not prove it here. See (Dunn [67])

3A.6.6 Theorem. (Converse of Sarkovskii's Theorem) Let $n \in \mathbb{N}$ and l precede n in Sarkovskii's ordering of the natural numbers. Then there exists a continuous function $f: \mathbb{R} \rightarrow \mathbb{R}$ which has a periodic point of prime period n , but no periodic point of prime period l .

A3.6.7 Remark. From the Converse of Sarkovskii's Theorem it follows, for example, that there exists a continuous function of \mathbb{R} into itself which has a periodic point of prime period 6, and hence a periodic point of prime period of each even number, but no periodic point of odd prime period except 1.

Exercises A3.6

1. Let f be a continuous mapping of an interval I into \mathbb{R} . Using Propositions 4.3.5 and 5.2.1, prove that $f(I)$ is an interval.
2. Use the Weierstrass Intermediate Value Theorem 5.2.9 to prove the following result:

Proposition A. *Let $a, b \in \mathbb{R}$ with $a < b$ and $f: I = [a, b] \rightarrow \mathbb{R}$ a continuous function. If $f(I) \supseteq I$, prove that f has a fixed point in I .*

[Hints. (i) Show that there exists points $s, t \in [a, b]$ such that $f(s) = c \leq a \leq s$ and $f(t) = d \geq b \geq t$.

(ii) Put $g(x) = f(x) - x$ and observe that g is continuous and $g(s) \leq 0$ and $g(t) \geq 0$.

(iii) Apply the Weierstrass Intermediate Value Theorem to g .]

3. Use the Weierstrass Intermediate Value Theorem 5.2.9 to prove the following result:

Proposition B. *Let $a, b \in \mathbb{R}$ with $a < b$. Further, let $f: [a, b] \rightarrow \mathbb{R}$ be a continuous function and $f([a, b]) \supseteq J = [c, d]$, for $c, d \in \mathbb{R}$ with $c < d$. Prove that there is a subinterval $I' = [s, t]$ of $I = [a, b]$ such that $f(I') = J$.*

[Hints. (i) Verify that $f^{-1}(\{c\})$ and $f^{-1}(\{d\})$ are non-empty closed sets.

(ii) Using (i) and Lemma 3.3.2 (above) verify that there is a largest number s such that $f(s) = c$.

(ii) Consider the case that there is some $x > s$ such that $f(x) = d$. Verify that there is a smallest number such that $t > s$ and $f(t) = d$.

(iii) Suppose that there is a $y \in [s, t]$ such that $f(y) < c$. Use the Weierstrass Intermediate Value Theorem to obtain a contradiction.

(iv) Show also in a similar fashion that there is no $z \in [s, t]$ such that $f(z) > d$.

(v) Deduce that, under the condition in (ii), $f([s, t]) = [c, d] = J$, as required.

(vi) Now consider the case that there is no $x > s$ such that $f(x) = d$. Let s' be the largest number such that $f(s') = d$. Clearly $s' < s$. Let t' be the smallest number such that $t' > s'$ and $f(t') = c$. Verify that $f([s', t']) = [c, d] = J$, as required.]

4. Let f be as in The Period Three Theorem A3.6.2. So there exists a point a in \mathbb{R} of prime period 3. So $f(a) = b$, $f(b) = c$, and $f(c) = a$, where $a \neq b$, $a \neq c$, and $b \neq c$. We shall consider the case $a < b < c$. The other cases are similarly handled. Put $I_0 = [a, b]$ and $I_1 = [b, c]$.

(i) Using Exercise 1 above, verify that $f(I_0) \supseteq I_1$.

(ii) Using Exercise 1 above again, verify that $f(I_1) \supseteq I_0 \cup I_1$.

(iii) Deduce from (ii) and Proposition B above that there is a closed interval $A_1 \subseteq I_1$, such that $f(A_1) = I_1$.

(iv) Noting that $f(A_1) = I_1 \supseteq A_1$, use Proposition B above again to show there exists a closed interval $A_2 \subseteq A_1$ such that $f(A_2) = A_1$.

(v) Observe that $A_2 \subseteq A_1 \subseteq I_1$ and $f^2(A_2) = I_1$.

(vi) Use mathematical induction to show that for $n \geq 3$ there are closed intervals A_1, A_2, \dots, A_{n-2} such that

$$A_{n-2} \subseteq A_{n-3} \subseteq \dots \subseteq A_2 \subseteq A_1 \subseteq I_1$$

such that $f(A_i) = A_{i-1}$, $i = 2, \dots, n-2$, and $f(A_1) = I_1$.

(vii) Deduce from (vi) that $f^{n-2}(A_{n-2}) = I_1$ and $A_{n-2} \subseteq I_1$.

(viii) Noting that $f(I_0) \supseteq I_1 \supseteq A_{n-2}$, show that there is a closed interval $A_{n-1} \subseteq I_0$ such that $f(A_{n-1}) = A_{n-2}$.

(ix) Finally, using the fact that $f(I_1) \supseteq I_0 \supseteq A_{n-1}$, show that there is a closed interval $A_n \subset I_1$ such that $f(A_n) = A_{n-1}$.

(x) Putting the above parts together we see

$$A_n \xrightarrow{f} A_{n-1} \xrightarrow{f} \dots \xrightarrow{f} A_1 \longrightarrow I_1$$

with $f(A_i) = A_{i-1}$ and $f^n(A_n) = I_1$. Use the fact that $A_n \subset I_1$ and Proposition A to show that there is a point $x_0 \in A_n$ such that $f^n(x_0) = x_0$.

(xi) Observe from (x) that the point x_0 is a periodic point of f of period n . [We have yet to show that x_0 is of **prime period** n .]

(xii) Using the fact that $f(x_0) \in A_{n-1} \subseteq I_0$ and $f^i(x_0) \in I_1$, for $i = 2, \dots, n$, and $I_0 \cap I_1 = \{b\}$, show that x_0 is of prime period n . [Note the possibility that $f(x_0) = b$ needs to be eliminated. This can be done by observing that $f^3(x_0) \in I_1$, but $f^2(b) = a \notin I_1$.]

- (xiii) From (xi) and (xii) and (vi), deduce that f has a periodic point of prime period n for every $n \geq 3$. [We deal with the cases $n = 1$ and $n = 2$ below.]
- (xiv) Use Proposition A and the fact that $f(I_1) \supseteq I_1$ to show there is a fixed point of f in I_1 ; that is there exists a periodic point of prime period 1.
- (xv) Note that $f(I_0) \supseteq I_1$ and $f(I_1) \supseteq I_0$. Using Proposition B show that there is a closed interval $B \subseteq I_0$ such that $f(B) = I_1$. Then, observe that $f^2(B) \supseteq I_0$, and from Proposition A, deduce that there exists a point $x_1 \in B$ such that $f^2(x_1) = x_1$. Verify that $x_1 \in B \subseteq I_0 = [a, b]$ while $f(x_1) \in f(B) = I_1 = [b, c]$ and $x_1 \neq b$. Deduce that x_1 is a periodic point of prime period 2 of f . This completes the proof of The Period Three Theorem.
5. (i) Show that The Period Three Theorem would be false if \mathbb{R} were replaced by \mathbb{R}^2 . [Hint. Consider a rotation about the origin.]
- (ii) Show that The Period Three Theorem would be false if \mathbb{R} were replaced by \mathbb{R}^n , $n \geq 2$.
- (iii) Show that The Period Three Theorem would be false if \mathbb{R} were replaced by S^1 , where S^1 is the circle centred at the origin of radius 1 in \mathbb{R}^2 .
6. Why is the Sarkovskii Theorem true when \mathbb{R} is replaced by the open interval (a, b) , for $a, b \in \mathbb{R}$ with $a < b$? [Hint. It's easy to deduce from Sarkovskii's Theorem for \mathbb{R} .]

A3.7 Chaotic Dynamical Systems

A3.7.1 Remarks. Today there are literally thousands of published research papers and hundreds of books dealing with chaotic dynamical systems. These are related to a variety of disciplines including art, biology, economics, ecology and finance. It would be folly to try to give a definitive history of chaos, a term used in the book of Genesis in the Bible and Hun-Tun (translated as chaos) in Taoism (Girardot [92]), a philosophical tradition dating back 2,200 years in China to the Han Dynasty. Here we focus on the twentieth century.

It would also be folly to try here to give the “correct” definition of the mathematical concept of chaos. Rather, we shall give one reasonable definition, noting there are others which are inequivalent. Indeed some mathematicians assert that no existing definition captures precisely what we want chaos to be.

As stated earlier, the 1975 paper of Yorke and Li triggered widespread interest in chaotic dynamical systems. However the previous year the Australian scientist Robert M. May, later Lord Robert May and President of the prestigious Royal Society of London published the paper (May [152]) in which he stated “Some of the simplest nonlinear difference equations describing the growth of biological populations with nonoverlapping generations can exhibit a remarkable spectrum of dynamical behavior, from stable equilibrium points, to stable cyclic oscillations between 2 population points, to stable cycles with 4, 8, 16, . . . points, through to a chaotic regime in which (depending on the initial population value) cycles of any period, or even totally aperiodic but bounded population fluctuations, can occur.”

Jules Henri Poincaré (1854-1912), one of France’s greatest mathematicians, is acknowledged as one of the founders of a number of fields of mathematics including modern nonlinear dynamics, ergodic theory, and topology. His work laid the foundations for chaos theory. He stated in his 1903 book, a translated version of which was republished in 2003 (Poincaré [183]): “If we knew exactly the laws of nature and the situation of the universe at its initial moment, we could predict exactly the situation of that same universe at a succeeding moment. But even if it were the case that the natural laws had no longer any secret for us, we could still only know the initial situation approximately. If that enabled us to predict the succeeding situation with the same approximation, that is all we require, and we should say that the phenomenon had been predicted, that it is governed by laws. But it is not always so; it may happen that small differences in the initial conditions produce very great ones in the final phenomena. A small error in the former will produce an enormous error in the latter. Prediction becomes impossible”. What Poincaré described quite precisely has subsequently become known colloquially as the *butterfly effect*, an essential feature of chaos.

In 1952 Collier’s magazine published a short story called “A Sound of Thunder” by the renowned author, Ray Bradbury (1920–). In the story a party of rich businessmen use time travel to journey back to a prehistoric era and go on a safari to hunt dinosaurs. However, one of the hunters accidentally kills a prehistoric butterfly, and this innocuous event dramatically changes the future world that they left. This was perhaps the incentive for a meteorologist’s presentation in 1973 to the American Association for the Advancement of Science in Washington, D.C. being given the name “Predictability: Does the flap of a butterfly’s wings in Brazil set off a tornado in Texas?” The meteorologist was Edward Norton Lorenz (1917–) and the flapping wing represented a tiny change in initial conditions causing enormous changes later. Lorenz discovered sensitivity to

initial conditions by accident. He was running on a computer a mathematical model to predict the weather. Having run a particular sequence, he decided to replicate it. He re-entered the number from his printout, taken part-way through the sequence, and let it run. What he found was that the new results were radically different from his first results. Because his printout rounded to three decimal places, he had entered the number .506 than the six digit number .506127. Even so, he would have expected that the resulting sequence would differ only slightly from the original run. Since repeated experimentation proved otherwise, Lorenz concluded that the slightest difference in initial conditions made a dramatic difference to the outcome. So prediction was in fact impossible. Sensitivity to initial conditions, or the butterfly effect, had been demonstrated to be not just of theoretical importance but in fact of practical importance in meteorology. It was a serious limitation to predicting the weather – at least with that model. Perhaps this effect was evident also in a variety of other practical applications.

The American mathematicians George David Birkhoff (1884–1944) and Harold Calvin Marston Morse (1892–1977) continued Poincaré’s work on dynamical systems. While Poincaré had made use of topology in the theory of dynamical systems, Birkhoff, in particular, supplemented this by the use of Lebesgue measure theory. In 1931 Birkhoff and P.A. Smith in their paper Birkhoff and Smith [25] introduced the concept of metric transitivity which is central in ergodic theory and was used by Robert L. Devaney in 1986 in his widely published definition of, and approach to, chaos.

The three conditions: transitivity, sensitivity to initial conditions, and density of of periodic points as appeared in The Period Three Theorem, were precisely what Devaney used in his definition of chaos. □

A3.7.2 Definition. Let (X, d) be a metric space and $f: X \rightarrow X$ a mapping of the set X into itself. Then (X, f) is said to be a **dynamical system**.

A3.7.3 Remark. It would be much more appropriate to denote the dynamical system as (X, d, f) , however in the literature the convention is not do this.

A3.7.4 Definition. Let (X, d) be a metric space and $f: X \rightarrow X$ a mapping of X into itself. Then the dynamical system (X, f) is said to be **transitive** if given $x, y \in X$, and any $\varepsilon > 0$, there exists a $z \in X$ and an $n \in \mathbb{N}$, such that $d(z, y) < \varepsilon$ and $d(f^n(z), x) < \varepsilon$.

A3.7.5 Remark. Roughly speaking, transitivity says that there is a point z “close” to y such that some point in the orbit of z is “close” to x .

A3.7.6 Remark. At long last we shall define chaos. However, care needs to be taken as there is a number of inequivalent definitions of chaos in the literature as well as many writers who are vague about what they mean by chaos. Our definition is that used by Robert L. Devaney, with a modification resulting from the work of a group of Australian mathematicians in 1992.

A3.7.7 Definition. The dynamical system (X, f) is said to be **chaotic** if

- (i) the set of all periodic points of f is dense in the set X , and
- (ii) (X, f) is transitive.

A3.7.8 Remark. Until 1992 it was natural to add a third condition in the definition of chaotic dynamical systems. This condition is that in the dynamical system (X, f) , f depends sensitively on initial conditions. However in 1992 a group of mathematicians from La Trobe University in Melbourne, Australia proved that this condition is automatically true if the two conditions in Definition A3.7.7 hold. Their work appeared in the paper “On Devaney’s definition of chaos” by the authors John Banks, Gary Davis, Peter Stacey, Jeff Brooks and Grant Cairns in the American Mathematical Monthly (Banks et al. [17]). See also (Banks et al. [18]).

A3.7.9 Definition. The dynamical system (X, f) is said to **depend sensitively on initial conditions** if there exists a $\beta > 0$ such that for any $x \in X$ and any $\varepsilon > 0$ there exists $n \in \mathbb{N}$ and $y \in X$ with $d(x, y) < \varepsilon$ such that $d(f^n(x), f^n(y)) > \beta$.

A3.7.10 Remark. This definition says that no matter which x we begin with and how small a neighbourhood of x we choose, there is always a y in this neighbourhood whose orbit separates from that of x by at least β . [And β is independent of x .]

A3.7.11 Remark. What we said in Remark A3.7.8 is that **every chaotic dynamical system depends sensitively on initial conditions**. We shall not prove this here. But we will show in Exercises A3.7 # 2 that the doubling map does indeed depend sensitively on initial conditions.

A3.7.12 Remark. In 1994, Michel Vellekoop and Raoul Berglund Vellekoop and Berglund [214] proved that in the special case that (X, d) is a finite or infinite interval with the Euclidean metric, then transitivity implies condition (ii) in Definition A3.7.7, namely that the set of all periodic points is dense. However, David Asaf and Steve Gadbois IV and Gadbois [123] showed this is not true for general metric spaces.

Exercises A3.7

1. Let $D: [0, 1) \rightarrow [0, 1)$ given by $D(x) = 2x \pmod{1}$ be the doubling map. Prove that the dynamical system $([0, 1), D)$ is chaotic.

[Hints. Recall that in Exercises A3.4 #7 it was proved that the set of all periodic points of D is

$$P = \bigcup_{n=1}^{\infty} \left\{ 0, \frac{1}{2^n - 1}, \frac{2}{2^n - 1}, \frac{3}{2^n - 1}, \dots, \frac{2^n - 2}{2^n - 1} \right\}.$$

and that the set P is dense in $[0, 1)$. So condition (i) of Definition A3.7.7 is satisfied. To verify condition (ii) use the following steps:

- (a) Let $x, y \in [0, 1)$ and $\varepsilon > 0$ be given. Let $n \in \mathbb{N}$ be such that $2^{-n} < \varepsilon$. For $k \in \{1, 2, \dots, n\}$, let

$$J_{k,n} = \left[\frac{k-1}{2^n}, \frac{k}{2^n} \right).$$

Show that there exists a $k \in \{1, 2, \dots, n\}$, such that $x \in J_{k,n}$.

- (b) Verify that $f^n(J_{k,n}) = [0, 1)$.
- (c) Deduce from (b) that there exists a $z \in J_{k,n}$ such that $f^n(z) = y$.
- (d) Deduce that z has the required properties of Definition A3.7.4 and so $([0, 1), D)$ is a transitive dynamical system.

(e) Deduce that $([0, 1), D)$ is a chaotic dynamical system.]

2. Prove that the doubling map of Exercise 1 above depends sensitively on initial conditions.
[Hints. Let $\beta = \frac{1}{4}$. Given any $\varepsilon > 0$, let $n \in \mathbb{N}$ be such that $2^{-n} < \varepsilon$. Put $s = f^n(x) + 0.251 \pmod{1}$. Firstly, verify that $d(f^n(x), s) > \beta$. As observed in Exercise 1(a), $x \in J_{k,n}$, for some $k \in \{1, 2, \dots, n\}$. But by Exercise 1(b), $f^n(J_{k,n}) = [0, 1)$. Let $y \in J_{k,n}$ be such that $f^n(y) = s$. Now verify that y has the required properties (i) $d(x, y) < \varepsilon$ and (ii) $d(f^n(x), f^n(y)) > \beta$.]
3. Let m be a (fixed) positive integer and consider the dynamical system $([0, 1), f_m)$ where $f_m(x) = mx \pmod{1}$. Prove that $([0, 1), f_m)$ is chaotic.
[Hint. See Exercise 1 above]
4. Let (X, \mathcal{T}) be a topological space and f a continuous mapping of X into itself. Then f is said to be **topologically transitive** if for any pair of non-empty open sets U and V in (X, \mathcal{T}) there exists an $n \in \mathbb{N}$ such that $f^n(U) \cap V \neq \emptyset$. For (X, d) a metric space and \mathcal{T} the topology induced by the metric d , prove that f is transitive if and only if it is topologically transitive.

A3.8 Conjugate Dynamical Systems

A3.8.1 Definition. Let (X_1, d_1) and (X_2, d_2) be metric spaces and (X_1, f_1) and (X_2, f_2) dynamical systems. Then (X_1, f_1) and (X_2, f_2) are said to be **conjugate dynamical systems** if there is a homeomorphism $h: (X_1, d_1) \rightarrow (X_2, d_2)$ such that $f_2 \circ h = h \circ f_1$; that is, $f_2(h(x)) = h(f_1(x))$, for all $x \in X_1$. The map h is called a **conjugate map**.

3A.8.2 Remark. In Exercises A3.8 #2 it is verified that if (X_1, f_1) and (X_2, f_2) are conjugate dynamical systems, then (X_2, f_2) and (X_1, f_1) are conjugate dynamical systems. So we see that the order in which the dynamical systems are considered is of no importance. \square

A3.8.3 Remark. Conjugate dynamical systems are equivalent in the same sense that homeomorphic topological spaces are equivalent. The next theorem demonstrates this fact. Very often it will be possible to analyze a complex dynamical system by showing it is conjugate to one we already understand. \square

A3.8.4 Theorem. Let (X_1, f_1) and (X_2, f_2) be conjugate dynamical systems, where h is the conjugate map.

- (i) A point $x \in X_1$ is a fixed point of f_1 in X_1 if and only if $h(x)$ is a fixed point of f_2 in X_2 .
- (ii) A point $x \in X_1$ is a periodic point of period $n \in \mathbb{N}$ of f_1 in X_1 if and only if $h(x)$ is a periodic point of period n of f_2 in X_2 .
- (iii) The dynamical system (X, f_1) is chaotic if and only if the dynamical system (X, f_2) is chaotic.

Proof. (i) and (ii) are straightforward and left as exercises for you.

To see (iii), assume that (X_1, f_1) is chaotic. Let P be the set of periodic points of f_1 . As (X_1, f_1) is chaotic, P is dense in X_1 . As h is a continuous, it is easily seen that $h(P)$ is dense in the set $h(X_1) = X_2$. As $h(P)$ is the set of periodic points of (X_2, f_2) , it follows (X_2, f_2) satisfies condition (i) of Definition A3.7.7.

To complete the proof, we need to show that (X_2, f_2) is transitive. To this end, let $\varepsilon > 0$ and $u, v \in X_2$. Then there are $x, y \in X_1$ such that $h(x) = u$ and $h(y) = v$. Since h is continuous, it is continuous at the points $x, y \in X_1$. Thus, there exists a $\delta > 0$ such that

$$z \in X_1 \quad \text{and} \quad d_1(x, z) < \delta \Rightarrow d_2(h(x), h(z)) < \varepsilon, \quad (10.1)$$

and

$$z' \in X_1 \quad \text{and} \quad d_1(y, z') < \delta \Rightarrow d_2(h(y), h(z')) < \varepsilon. \quad (10.2)$$

As (X_1, f_1) is transitive, there is a $z \in X_1$ and $n \in \mathbb{N}$, such that

$$d_1(x, z) < \delta \Rightarrow d_1(f_1^n(z), y) < \delta. \quad (10.3)$$

Let z be chosen so that (10.3) holds, and put $w = h(z)$. Using this value for z in (10.1), and taking $f_1^n(z)$ as z' in (10.2), we obtain

$$d_2(u, w) = d_2(h(x), h(z)) < \varepsilon, \quad \text{from (10.1) and (10.3)} \quad (10.4)$$

and

$$\begin{aligned}
 d_2(f_2^n(w), v) &= d_2(f_2^n(h(z)), h(y)), \\
 &= d_2(h(f_1^n(z)), h(y)), \quad \text{as } h \circ f_1 = f_2 \circ h, \\
 &< \varepsilon,
 \end{aligned} \tag{10.5}$$

from (2) and (3). Now from (10.4) and (10.5) it follows that (X_2, f_2) is transitive. \square

Exercises A3.8

1. Let $T: [0, 1] \rightarrow [0, 1]$ be the **tent function** given by

$$T(x) = \begin{cases} 2x, & \text{for } 0 \leq x \leq \frac{1}{2}, \\ 2 - 2x, & \text{for } \frac{1}{2} \leq x \leq 1. \end{cases}$$

(i) Sketch the graph of T .

(ii) Calculate the formula for T^2 and sketch the graph of T^2 .

(iii) Calculate the formula for T^3 and sketch the graph of T^3 .

(iv) Let $I_{k,n} = [\frac{k-1}{2^n}, \frac{k}{2^n}]$, for $k \in \{1, 2, \dots, 2^n - 1\}$, $n \in \mathbb{N}$. Verify that $T^n(I_{k,n}) = [0, 1]$.

(v) Using Proposition A of Exercises 3.6 #2, show that T^n has a fixed point in each $I_{k,n}$.

(vi) Deduce from (v) that there is a periodic point of T in each $I_{k,n}$.

(vii) Using the above results show that $(T, [0, 1])$ is a chaotic dynamical system.

2. Verify that if (X_1, f_1) and (X_2, f_2) are conjugate dynamical systems then (X_2, f_2) and (X_1, f_1) are conjugate dynamical systems. (So the order in which the dynamical systems are considered is of no importance.)

3. Let $L: [0, 1] \rightarrow [0, 1]$ be the logistic function given by $L(x) = 4x(1 - x)$.

(i) Show that the map $h: [0, 1] \rightarrow [0, 1]$ given by $h(x) = \sin^2(\frac{\pi}{2}x)$, is a homeomorphism of $[0, 1]$ onto itself such that $h \circ T = L \circ h$, where T is the tent function.

(ii) Deduce that $([0, 1], T)$ and $([0, 1], L)$ are conjugate dynamical systems.

(iii) Deduce from (ii), Theorem A3.8.4 and Exercise 1 above that $([0, 1], L)$ is a chaotic dynamical system.

4. Consider the quadratic map $Q_{-2}: [-2, 2] \rightarrow [-2, 2]$, where $Q_{-2}(x) = x^2 - 2$.

(i) Prove that the dynamical systems $([-2, 2], Q_{-2})$ and $([0, 1], L)$ of Exercise 3 above are conjugate.

(ii) Deduce that $([-2, 2], Q_{-2})$ is a chaotic dynamical system.

Appendix 4: Hausdorff Dimension

Introduction

In this section we introduce the notion of Hausdorff Dimension which plays an important role in the study of fractals.

A4.1 Hausdorff Dimension

We begin by warning the reader that this section is significantly more complicated than much of the material in the early chapters of this book. Further, an understanding of this section is not essential to the understanding of the rest of the book.

We think of points as 0-dimensional, lines as 1-dimensional, squares as 2-dimensional, cubes as 3-dimensional etc. So intuitively we think we know what the notion of dimension is. For arbitrary topological spaces there are competing notions of topological dimension. In “nice” spaces, the different notions of topological dimension tend to coincide. However, even the well-behaved euclidean spaces, \mathbb{R}^n , $n > 1$, have surprises in store for us.

In 1919 Felix Hausdorff introduced the notion of Hausdorff dimension of a metric space. A surprising feature of Hausdorff dimension is that it can have values which are not integers. This topic was developed by Abram Samoilovitch Besicovitch a decade or so later, but came into prominence in the 1970s with the work of Benoit Mandelbrot on what he called fractal geometry and which spurred the development of chaos theory. Fractals and chaos theory have been used in a very wide range of disciplines including economics, finance, meteorology, physics, and physiology.

We begin with a discussion of Hausdorff measure (or what some call Hausdorff-Besicovitch measure). Some readers will be familiar with the related notion of Lebesgue measure, however such an understanding is not essential here.

A4.1.1 Definition. Let Y be a subset of a metric space (X, d) . Then the number $\sup\{d(x, y) : x, y \in Y\}$ is said to be the **diameter** of the set Y and is denoted $\text{diam } Y$.

A4.1.2 Definition. Let Y be a subset of a metric space (X, d) , I an index set, ε a positive real number, and $\{U_i : i \in I\}$ a family of subsets of X such that $Y \subseteq \bigcup_{i \in I} U_i$ and, for each $i \in I$, $\text{diam } U_i < \varepsilon$. Then $\{U_i : i \in I\}$ is said to be an **ε -covering** of the set Y .

We are particularly interested in ε -coverings which are countable. So we are led to ask: which subsets of a metric space have countable ε -coverings for all $\varepsilon > 0$? The next Proposition provides the answer.

A4.1.3 Proposition. Let Y be a subset of a metric space (X, d) and d_1 the induced metric on Y . Then Y has a countable ε -covering for all $\varepsilon > 0$ if and only if (Y, d_1) is separable.

Proof. Assume that Y has a countable ε -covering for all $\varepsilon > 0$. In particular Y has a countable $(1/n)$ -covering, $\{U_{n,i} : i \in \mathbb{N}\}$, for each $n \in \mathbb{N}$. Let $y_{n,i}$ be any point in $Y \cap U_{n,i}$. We shall see that the countable set $\{y_{n,i} : i \in \mathbb{N}, n \in \mathbb{N}\}$ is dense in Y . Clearly for each $y \in Y$, there exists an $i \in \mathbb{N}$, such that $d(y, y_{n,i}) < 1/n$. So let O be any open set intersecting Y non-trivially. Let $y \in O \cap Y$. Then O contains an open ball B centre y of radius $1/n$, for some $n \in \mathbb{N}$. So $y_{n,i} \in O$, for some $i \in \mathbb{N}$. Thus $\{y_{n,i} : i \in \mathbb{N}, n \in \mathbb{N}\}$ is dense in Y and so Y is separable.

Conversely, assume that Y is separable. Then it has a countable dense subset $\{y_i : i \in \mathbb{N}\}$. Indeed, given any $y \in Y$ and any $\varepsilon > 0$, there exists a y_i , $i \in \mathbb{N}$, such that $d(y, y_i) < \varepsilon/2$. So the family of all $\{U_i : i \in \mathbb{N}\}$, where U_i is the open ball centre y_i and radius $\varepsilon/2$ is an ε -covering of Y , as required. \square

We are now able to define the Hausdorff s -dimensional measure of a subset of a metric space. More precisely, we shall define this measure for separable subsets of a metric space. Of course, if (X, d) is a separable metric space, such as \mathbb{R}^n , for any $n \in \mathbb{N}$, then all of its subsets are separable. (See Exercises 6.3 #15.)

A4.1.4 Definition. Let Y be a separable subset of a metric space (X, d) and s a positive real number. For each positive real number $\varepsilon < 1$, put

$$\mathcal{H}_\varepsilon^s(Y) = \inf \left\{ \sum_{i \in \mathbb{N}} (\text{diam } U_i)^s : \{U_i : i \in \mathbb{N}\} \text{ is an } \varepsilon\text{-covering of } Y \right\}, \text{ and}$$

$$\mathcal{H}^s(Y) = \begin{cases} \lim_{\substack{\varepsilon \rightarrow 0 \\ \varepsilon > 0}} \mathcal{H}_\varepsilon^s(Y), & \text{if the limit exists;} \\ \infty, & \text{otherwise.} \end{cases}$$

Then $\mathcal{H}^s(Y)$ is said to be the **s -dimensional Hausdorff outer measure** of the set Y .

A4.1.5 Remark. Note that in Definition A4.1.4, if $\varepsilon_1 < \varepsilon_2$, then $\mathcal{H}_{\varepsilon_1}^s(Y) \geq \mathcal{H}_{\varepsilon_2}^s(Y)$. So as ε tends to 0, either the limit of $\mathcal{H}_\varepsilon^s(Y)$ exists or it tends to ∞ . This helps us to understand the definition of $\mathcal{H}^s(Y)$.

A4.1.6 Remark. It is important to note that if d_1 is the metric induced on Y by the metric d on X , then $\mathcal{H}^s(Y)$ depends only on the metric d_1 on Y . In other words if Y is also a subset of the metric space (Z, d_2) and d_2 induces the same metric d_1 on Y , then $\mathcal{H}^s(Y)$ is the same when considered as a subset of (X, d) or (Y, d_2) . So, for example, the s -dimensional Hausdorff outer measure is the same for the closed interval $[0, 1]$ whether considered as a subset of \mathbb{R} or of \mathbb{R}^2 or indeed of \mathbb{R}^n , for any positive integer n .

A4.1.7 Lemma. Let Y be a separable subset of a metric space (X, d) , s and t positive real numbers with $s < t$, and ε a positive real number < 1 . Then

(i) $H_\varepsilon^t(Y) \leq H_\varepsilon^s(Y)$, and

(ii) $H_\varepsilon^t(Y) \leq \varepsilon^{t-s} H_\varepsilon^s(Y)$.

Proof. Part (i) is an immediate consequence of the fact that $\varepsilon < 1$ and so each $\text{diam } U_i < 1$, which implies $(\text{diam } U_i)^t < (\text{diam } U_i)^s$. Part (ii) follows from the fact that $\text{diam } U_i < \varepsilon < 1$ and so $(\text{diam } U_i)^t < \varepsilon^{t-s} (\text{diam } U_i)^s$. \square

A4.1.8 Proposition. Let Y be a separable subset of a metric space (X, d) and s and t positive real numbers with $s < t$.

(i) If $\mathcal{H}^s(Y) < \infty$, then $\mathcal{H}^t(Y) = 0$.

(ii) If $0 \neq \mathcal{H}^t(Y) < \infty$, then $\mathcal{H}^s(Y) = \infty$.

Proof. These follow immediately from Definition A4.1.3 and Lemma A4.1.7ii). □

A4.1.9 Remark. From Proposition A4.1.8 we see that if $\mathcal{H}^s(Y)$ is finite and non-zero for some value of s , then for all larger values of s , $\mathcal{H}^s(Y)$ equals 0 and for all smaller values of s , $\mathcal{H}^s(Y)$ equals ∞ . □

Proposition A4.1.8 allows us to define Hausdorff dimension.

A4.1.10 Definition. Let Y be a separable subset of a metric space (X, d) . Then

$$\dim_H(Y) = \begin{cases} \inf\{s \in [0, \infty) : \mathcal{H}^s(Y) = 0\}, & \text{if } \mathcal{H}^s(Y) = 0 \text{ for some } s > 0; \\ \infty, & \text{otherwise} \end{cases}$$

is called the **Hausdorff dimension** of the set Y .

We immediately obtain the following Proposition.

A4.1.11 Proposition. Let Y be a separable subset of a metric space (X, d) . Then

$$\begin{aligned} \text{(i)} \quad \dim_H(Y) &= \begin{cases} 0, & \text{if } \mathcal{H}^s(Y) = 0 \text{ for all } s; \\ \sup\{s \in [0, \infty) : \mathcal{H}^s(Y) = \infty\}, & \text{if the supremum exists;} \\ \infty, & \text{otherwise.} \end{cases} \\ \text{(ii)} \quad \mathcal{H}^s(Y) &= \begin{cases} 0, & \text{if } s > \dim_H(Y); \\ \infty, & \text{if } s < \dim_H(Y). \end{cases} \end{aligned}$$

□

The calculation of the Hausdorff dimension of a metric space is not an easy exercise. But here is an instructive example.

A4.1.12 Example. Let Y be any finite subset of a metric space (X, d) . Then $\dim_H(Y) = 0$.

Proof. Put $Y = \{y_1, y_2, \dots, y_N\}$, $N \in \mathbb{N}$. Let $O_\varepsilon(i)$ be the open ball centre y_i and radius $\varepsilon/2$. Then $\{O_i : i = 1, \dots, N\}$ is an ε -covering of Y . So

$$\mathcal{H}_\varepsilon^s(Y) = \inf \left\{ \sum_{i \in \mathbb{N}} (\text{diam } U_i)^s : \{U_i\} \text{ an open covering of } Y \right\} \leq \sum_{i=1}^N (\text{diam } O_i)^s = \varepsilon^s \cdot N^{s+1} / 2^s.$$

Thus $\mathcal{H}^s(Y) \leq \lim_{\substack{\varepsilon \rightarrow 0 \\ \varepsilon > 0}} \varepsilon^s \cdot N^{s+1} / 2^s = 0$. So $\mathcal{H}^s(Y) = 0$, for all $s > 0$. Hence $\dim_H(Y) = 0$. \square

The next Proposition is immediate.

A4.1.13 Proposition. If (Y_1, d_1) and (Y_2, d_2) are isometric metric spaces, then

$$\dim_H(Y_1) = \dim_H(Y_2). \quad \square$$

A4.1.14 Proposition. Let Z and Y be separable subsets of a metric space (X, d) . If $Z \subset Y$, then $\dim_H(Z) \leq \dim_H(Y)$.

Proof. Exercise. \square

A4.1.15 Lemma. Let $Y = \bigcup_{i \in \mathbb{N}} Y_i$ be a separable subset of a metric space (X, d) . Then

$$\mathcal{H}^s(Y) \leq \sum_{i=1}^{\infty} \mathcal{H}^s(Y_i).$$

Proof. Exercise. \square

A4.1.16 Proposition. Let $Y = \bigcup_{i \in \mathbb{N}} Y_i$ be a separable subset of a metric space (X, d) . Then

$$\dim_H(Y) = \sup\{\dim_H(Y_i) : i \in \mathbb{N}\}.$$

Proof. It follows immediately from Lemma A4.1.15 that

$$\dim_H(Y) \leq \sup\{\dim_H(Y_i) : i \in \mathbb{N}\}.$$

However, by Proposition A4.1.14, $\dim_H(Y) \geq \dim_H(Y_i)$, for each $i \in \mathbb{N}$. Putting these two observations together completes the proof of the Proposition. \square

A4.1.17 Proposition. If Y is a countable subset of a metric space (X, d) , then $\dim_H(Y) = 0$.

Proof. This follows immediately from Proposition A4.1.16 and Example A4.1.12 \square

In particular, Proposition A4.1.17 tells us that $\dim_H(\mathbb{Q}) = 0$.

A4.1.18 Example. Let $[a, a + 1]$, $a \in \mathbb{R}$ be a closed interval in \mathbb{R} , where \mathbb{R} has the euclidean metric. Then $\dim_H[a, a + 1] = \dim_H[0, 1] = \dim_H(\mathbb{R})$.

Proof. Let d_a be the metric induced on $[a, a + 1]$ by the euclidean metric on \mathbb{R} . Then $([a, a + 1], d_a)$ is isometric to $([0, 1], d_0)$, and so by Proposition A4.1.13, $\dim_H[a, a + 1] = \dim_H[0, 1]$.

Now observe that $\mathbb{R} = \bigcup_{a=-\infty}^{\infty} [a, a + 1]$. So

$$\dim_H(\mathbb{R}) = \sup\{\dim_H[a, a + 1] : a = \dots, -n, \dots, -2, -1, 0, 1, 2, \dots, n, \dots\} = \dim_H[0, 1],$$

as each $\dim_H[a, a + 1] = \dim_H[0, 1]$. \square

A4.1.19 Proposition. Let (X, d_1) and (Y, d_2) be separable metric spaces and $f : X \rightarrow Y$ a surjective function. If there exist positive real numbers a and b , such that for all $x_1, x_2 \in X$,

$$a \cdot d_1(x_1, x_2) \leq d_2(f(x_1), f(x_2)) \leq b \cdot d_1(x_1, x_2),$$

then $\dim_H(X, d_1) = \dim_H(Y, d_2)$.

Proof. Exercise

A4.1.20 Remark. In some cases Proposition A4.1.19 is useful in calculating the Hausdorff dimension of a space. See Exercises 6.6 #7 and #8.

Another useful device in calculating Hausdorff dimension is to refine the definition of the s -dimensional Hausdorff outer measure as in the following Proposition, where all members of the ε -covering are open sets.

A4.1.21 Proposition. Let Y be a separable subset of a metric space (X, d) and s a positive real number. If for each positive real number $\varepsilon < 1$,

$$\mathcal{O}_\varepsilon^s(Y) = \inf \left\{ \sum_{i \in \mathbb{N}} (\text{diam } O_i)^s : \{O_i : i \in \mathbb{N}\} \text{ is an } \varepsilon\text{-covering of } Y \text{ by open sets } O_i \right\},$$

then $\mathcal{O}_\varepsilon^s(Y) = \mathcal{H}_\varepsilon^s(Y)$.

$$\text{Further } \mathcal{H}^s(Y) = \begin{cases} \lim_{\substack{\varepsilon \rightarrow 0 \\ \varepsilon > 0}} \mathcal{O}_\varepsilon^s(Y), & \text{if the limit exists;} \\ \infty, & \text{otherwise.} \end{cases}$$

Proof. Exercise.

A4.1.22 Lemma. Let Y be a connected separable subset of a metric space (X, d) . If $\{O_i : i \in \mathbb{N}\}$ is a covering of Y by open sets O_i , then

$$\sum_{i \in \mathbb{N}} \text{diam } O_i \geq \text{diam } Y$$

Proof. Exercise.

A4.1.23 Example. Show $\mathcal{H}^1[0, 1] \geq 1$.

Proof. If we put $Y = [0, 1]$ in Lemma A4.1.22 and $s = 1$ in Proposition A4.1.21, noting $\text{diam}[0, 1] = 1$ yields $\mathcal{H}_\varepsilon^1[0, 1] \geq 1$, for all $\varepsilon > 0$. This implies the required result. \square

A4.1.24 Proposition. Let $[0, 1]$ denote the closed unit interval with the euclidean metric. Then $\dim_H[0, 1] = 1$.

Proof. From Proposition A4.1.11, it suffices to show that $0 \neq \mathcal{H}^1[0, 1] < \infty$. This is the case if we show $\mathcal{H}^1[0, 1] = 1$.

For any $1 > \varepsilon > 0$, it is clear that the interval $[0, 1]$ can be covered by n_ε intervals each of diameter less than ε , where $n_\varepsilon \leq 2 + 1/\varepsilon$. So $\mathcal{H}_\varepsilon^1[0, 1] \leq \varepsilon(2 + 1/\varepsilon)$; that is, $\mathcal{H}_\varepsilon^1[0, 1] \leq 1 + 2\varepsilon$. Thus $\mathcal{H}^1[0, 1] \leq 1$. From Example A4.1.23, we now have $\mathcal{H}^1[0, 1] = 1$, from which the Proposition follows. \square

A similar argument to that above shows that if $a, b \in \mathbb{R}$ with $a < b$, where \mathbb{R} has the euclidean metric, then $\dim_H[a, b] = 1$. The next Corollary includes this result and is an easy consequence of combining Proposition A4.1.24, Example A4.1.18, Proposition A4.1.14, Proposition 4.3.5, and the definition of totally disconnected in Exercises 5.2 #10.

A4.1.25 Corollary. Let \mathbb{R} denote the set of all real numbers with the euclidean metric.

- (i) $\dim_H \mathbb{R} = 1$.
- (ii) If $S \subset \mathbb{R}$, then $\dim_H S \leq 1$.
- (iii) If S contains a non-trivial interval (that is, is not totally disconnected), then $\dim_H S = 1$.
- (iv) If S is a non-trivial interval in \mathbb{R} , then $\dim_H S = 1$.

Proof. Exercise \square

A4.1.26 Remark. In fact if \mathbb{R}^n has the euclidean metric, with $n \in \mathbb{N}$, then it is true that $\dim_H \mathbb{R}^n = n$. This is proved in Exercises A4.1. However, the proof there depends on the Generalized Heine-Borel Theorem 8.3.3 which is not proved until Chapter 8.

This appendix on Hausdorff dimension is not yet complete. From time to time please check for updates online at <http://uob-community.ballarat.edu.au/~smorris/topology.htm>.

Exercises 10.5

1. Let Y be a subset of a metric space (X, d) and \bar{Y} its closure. Prove that $\text{diam } Y = \text{diam } \bar{Y}$.
2. Prove Proposition A4.1.14.
[Hint. Use Definitions A4.1.4 and A4.1.10.]
3. Prove Lemma A4.1.15.
4. If $Y = \bigcup_{i=1}^n Y_i$, for some $n \in \mathbb{N}$, is a separable subset of a metric space (X, d) , show that $\dim_H(Y) = \sup\{\dim_H(Y_i) : i = 1, 2, \dots, n\}$.
5. (i) Let $n \in \mathbb{N}$, and $a, b \in \mathbb{R}^n$. Show that if r and s are any positive real numbers, then the open balls $B_r(a)$ and $B_s(b)$ in \mathbb{R}^n with the euclidean metric satisfy

$$\dim_H B_r(a) = \dim_H B_s(b).$$

- (ii) Using the method of Example A4.1.18, show that $\dim_H B_r(a) = \dim \mathbb{R}^n$.
 - (ii) If S_1 is the open cube $\{\langle x_1, x_2, \dots, x_n \rangle \in \mathbb{R}^n : 0 < x_i < 1, i = 1, \dots, n\}$, prove that $\dim_H S_1 = \dim_H \mathbb{R}^n$.
 - (iii)* Using the method of Proposition A4.1.24, show that if $n = 2$ then $\mathcal{H}^2(S_1) \leq 2$ and so $\dim_H(S_1) \leq 2$.
 - (iv) Prove that $\dim_H \mathbb{R}^2 \leq 2$.
 - (v)* Using an analogous argument, prove that $\dim_H \mathbb{R}^n \leq n$, for all $n > 2$.
6. Prove Proposition A4.1.19.
[Hint. Prove that $a^s \mathcal{H}^s(X) \leq \mathcal{H}^s(Y) \leq b^s \mathcal{H}^s(X)$.]
 7. Let $f: \mathbb{R} \rightarrow \mathbb{R}^2$ be the function given by $f(x) = \langle x, x^2 \rangle$. Using Proposition A4.1.19, show that $\dim_H f[0, 1] = \dim_H[0, 1]$. Deduce from this and Proposition A4.1.16 that if Y is the graph in \mathbb{R}^2 of the function $\theta: \mathbb{R} \rightarrow \mathbb{R}$ given by $\theta(x) = x^2$, then $\dim_H(Y) = \dim_H[0, 1]$.
 8. Using an analogous argument to that in Exercise 7 above, show that if Z is the graph in \mathbb{R}^2 of any polynomial $\phi(x) = a_n x^n + a_{n-1} x^{n-1} + \dots + a_2 x^2 + a_1 x + a_0$, where $a_n \neq 0$, then $\dim_H Z = \dim_H[0, 1]$.

- 9.* Let $g : \mathbb{R} \rightarrow \mathbb{R}$ be a function such that the n^{th} -derivative $g^{(n)}$ exists, for each $n \in \mathbb{N}$. Further assume that there exists a $K \in \mathbb{N}$, $|g^{(n)}(x)| < K$, for all $n \in \mathbb{N}$ and all $x \in [0, 1]$. (Examples of such functions include $g = \exp$, $g = \sin$, $g = \cos$, and g is a polynomial.) Using the Taylor series expansion of g , extend the method of Exercises 7 and 8 above to show that if $f : \mathbb{R} \rightarrow \mathbb{R}^2$ is given by $f(x) = \langle x, g(x) \rangle$, then $\dim_H f[0, 1] = \dim_H [0, 1]$.
10. Prove Proposition A4.1.21.
[Hint. Firstly prove that if z is any positive real number greater than 1, and U_i is any set in (X, d) of diameter less than ε , then there exists an open set O_i such that (i) $U_i \subseteq O_i$, (ii) $\text{diam } O_i < \varepsilon$, and (iii) $\text{diam } O_i \leq z \cdot \text{diam } U_i$. Use this to show that $\mathcal{O}_\varepsilon^s(Y) \leq z^s \cdot \mathcal{H}_\varepsilon^s(Y)$, for all $z > 1$.]
11. Prove Lemma A4.1.22.
[Hint. First assume that Y is covered by 2 open sets and prove the analogous result. Then consider the case that Y is covered by a finite number of open sets. Finally consider the case of an infinite covering remembering a sum of an infinite number of terms exists (and is finite) if and only if the limit of the finite sums exist.]
12. Show that if \mathbb{P} denotes the set of all irrational numbers with the euclidean metric, then $\dim_H \mathbb{P} = 1$
13. Fill in the details of the proof of Corollary A4.1.25.
14. The Generalized Heine-Borel Theorem 8.3.3 proved in Chapter 8, implies that if $\{O_i : i \in \mathbb{N}\}$ is an ε -covering of the open cube S_1 of Example 5 above, then there exists an $N \in \mathbb{N}$, such that $\{O_1, O_2, \dots, O_N\}$ is also an ε -covering of S_1 . Using this, extend Proposition A4.1.21 to say that: For every positive real number ε ,

$$\mathcal{H}_\varepsilon^s(S_1) = \inf \left\{ \sum_{i=1}^N (\text{diam } O_i)^s : \text{where } N \in \mathbb{N} \text{ and } O_1, \dots, O_N \text{ is an open } \varepsilon \text{ covering of } S_1 \right\}.$$

Warning: Note that this Exercise depends on a result not proved until Chapter 8.

15. (i) Show that if O is a subset of \mathbb{R}^2 with the euclidean metric, and A is its area, then

$$A \leq \frac{\pi}{4} \cdot (\text{diam } O)^2.$$

(ii) Deduce from (i) that if O_1, O_2, \dots, O_N is an ε -covering of S_1 in \mathbb{R}^2 of Example 5 above, then

$$\sum_{i=1}^N (\text{diam } O_i)^2 \geq \frac{4}{\pi}.$$

(iii) Deduce from (ii) and Exercise 14 above that $\mathcal{H}^2(S_1) \geq \frac{4}{\pi}$.

(iv) Using (iii) and Exercise 5, prove that $\dim_H(S_1) = \dim_H \mathbb{R}^2 = 2$.

(v) Using an analogous method to that above, prove that $\dim_H \mathbb{R}^n = n$, where \mathbb{R}^n has the euclidean metric.

(vi) Prove that if S is any subset of \mathbb{R}^n with the euclidean metric, such that S contains a non-empty open ball in \mathbb{R}^n , the $\dim_H S = n$.

Warning: Note that (iii), (iv), (v), and (vi) of this Exercise depend on a result proved in Chapter 8.

Appendix 5: Topological Groups

Introduction

In this Appendix we give an introduction to the theory of topological groups. It assumes that the reader is familiar with the notion of **group** as is included in an introductory course on group theory or usually in an introductory course on abstract algebra.

A5.1 Topological Groups

A5.1.1 Definition. Let (G, \mathcal{T}) be a set G , that is a group, with a topology \mathcal{T} on G . Then (G, \mathcal{T}) is said to be a **topological group** if

- (i) the mapping $(x, y) \rightarrow xy$ of the product space $(G, \mathcal{T}) \times (G, \mathcal{T})$ onto (G, \mathcal{T}) is continuous, and
- (ii) the mapping $x \rightarrow x^{-1}$ of (G, \mathcal{T}) onto (G, \mathcal{T}) is continuous.

A5.1.2 Examples.

- (1) The additive group of real numbers with the euclidean topology is a topological group, usually denoted by \mathbb{R} .
- (2) The multiplicative group of positive real numbers with the induced topology from \mathbb{R} is also a topological group.
- (3) The additive group of rational numbers with the euclidean topology is a topological group denoted by \mathbb{Q} .
- (4) The additive group of integers with the discrete topology is a topological group denoted by \mathbb{Z} .
- (5) Any group with the discrete topology is a topological group.
- (6) Any group with the indiscrete topology is a topological group.
- (7) The "circle" group consisting of the complex numbers of modulus one (i.e. the set of numbers $e^{2\pi ix}$, $0 \leq x < 1$) with the group operation being multiplication of complex numbers and the topology induced from the euclidean topology on the complex plane is a topological group. This topological group is denoted by \mathbb{T} (or S^1).
- (8) **Linear groups.** Let $A = (a_{jk})$ be an $n \times n$ matrix, where the coefficients a_{jk} are complex numbers. The transpose tA of the matrix A is the matrix (a_{kj}) and the conjugate \bar{A} of A is the matrix (\bar{a}_{jk}) , where \bar{a}_{jk} is the complex conjugate of the number a_{jk} . The matrix A is said to be **orthogonal** if $A = \bar{A}$ and ${}^tA = A^{-1}$ and **unitary** if $A^{-1} = {}^t(\bar{A})$.

The set of all non-singular $n \times n$ matrices (with complex number coefficients) is called the **general linear group** (over the complex number field) and is denoted by $GL(n, \mathbb{C})$. The subgroup $GL(n, \mathbb{C})$ consisting of those matrices with determinant one is the **special linear group** (over the complex field) and is denoted by $SL(n, \mathbb{C})$. The **unitary group** $U(n)$ and the **orthogonal group** $O(n)$ consist of all unitary matrices and all orthogonal matrices, respectively; they are subgroups of $GL(n, \mathbb{C})$. Finally we define the **special unitary group** and the **special orthogonal group** as $SU(n) = SL(n, \mathbb{C}) \cap U(n)$ and $SO(n) = SL(n, \mathbb{C}) \cap O(n)$, respectively.

The group $GL(n, \mathbb{C})$ and all its subgroups can be regarded as subsets of \mathbb{C}^{n^2} , where \mathbb{C} denotes the complex number plane, and so \mathbb{C}^{n^2} is a $2n^2$ -dimension euclidean space. As such $GL(n, \mathbb{C})$ and all its subgroups have induced topologies and it is easily verified that, with these, they are topological groups.

A5.1.3 Remark. Of course not every topology on a group makes it into a topological group; i.e. the group structure and the topological structure need not be compatible. If a topology \mathcal{T} on a group G makes (G, \mathcal{T}) into a topological group, then \mathcal{T} is said to be a **group topology** or a **topological group topology**

A5.1.4 Example. Let G be the additive group of integers. Define a topology \mathcal{T} on G as follows: a subset U of G is open if either

- (a) $0 \notin U$, or
- (b) $G \setminus U$ is finite.

Clearly this is a (compact Hausdorff) topology, but Proposition A5.1.5 below shows that (G, \mathcal{T}) is not a topological group.

A5.1.5 Proposition. Let (G, \mathcal{T}) be a topological group. For each $a \in G$, left and right translation by a are homeomorphisms of (G, \mathcal{T}) . Inversion is also a homeomorphism.

Proof. The map $L_a : (G, \mathcal{T}) \rightarrow (G, \mathcal{T})$ given by $g \mapsto ag$ is the product of the two continuous maps

$(G, \mathcal{T}) \rightarrow (G, \mathcal{T}) \times (G, \mathcal{T})$ given by $g \mapsto (a, g)$, where $g \in G$, a is fixed, and

$(G, \mathcal{T}) \times (G, \mathcal{T}) \rightarrow (G, \mathcal{T})$ given by $(x, y) \mapsto xy$, $x, y \in G$,

and is therefore continuous. So left translation by any $a \in G$ is continuous. Further, L_a has a continuous inverse, namely $L_{a^{-1}}$, since $L_a[L_{a^{-1}}(g)] = L_a[a^{-1}g] = a(a^{-1}g) = g$ and $L_{a^{-1}}[L_a(g)] = L_{a^{-1}}[ag] = a^{-1}(ag) = g$. So left translation is a homeomorphism. Similarly right translation is a homeomorphism.

The map $I : (G, \mathcal{T}) \rightarrow (G, \mathcal{T})$ given by $g \mapsto g^{-1}$ is continuous, by definition. Also I has a continuous inverse, namely I itself, as $I[I(g)] = I[g^{-1}] = [g^{-1}]^{-1} = g$. So I is also a homeomorphism. \square

It is now clear that the (G, \mathcal{T}) in Example A5.1.4 above is not a topological group as left translation by 1 takes the open set $\{-1\}$ onto $\{0\}$, but $\{0\}$ is not an open set. What we are really saying is that any topological group is a homogeneous space while the example is not. Homogeneous spaces are defined next.

A5.1.6 Definition. A topological space (X, \mathcal{T}) is said to be **homogeneous** if it has the property that for each ordered pair x, y of points of X , there exists a homeomorphism $f : (X, \mathcal{T}) \rightarrow (X, \mathcal{T})$ such that $f(x) = y$.

While every topological group is a homogeneous topological space, we will see shortly that not every homogeneous space can be made into a topological group.

A5.1.7 Definition. A topological space is said to be a **T_1 -space** if each point in the space is a closed set.

It is readily seen that any Hausdorff space is a T_1 -space but that the converse is false. See Exercises 4.1 #13.

We will see, however, that any topological group which is a T_1 -space is Hausdorff. Incidentally, this is not true, in general, for homogeneous spaces—as any infinite set with the cofinite topology is a homogeneous T_1 space but is not Hausdorff. As a consequence we will then have that **not every homogeneous space can be made into a topological group.**

A5.1.8 Proposition. Let (G, \mathcal{T}) be any topological group and e its identity element. If U is any neighbourhood of e , then there exists an open neighbourhood V of e such that

(i) $V = V^{-1}$ (that is, V is a **symmetric neighbourhood of the identity e**)

(ii) $V^2 \subseteq U$.

(Here $V^{-1} = \{v^{-1} : v \in V\}$ and $V^2 = \{v_1 v_2 : v_1 \in V, v_2 \in V\}$, not the set $\{v^2 : v \in V\}$.)

Proof. Exercise. □

A5.1.9 Proposition. Any topological group (G, \mathcal{T}) which is a T_1 -space is also a Hausdorff space.

Proof. Let x and y be distinct points of G . Then $x^{-1}y \neq e$. The set $G \setminus \{x^{-1}y\}$ is an open neighbourhood of e and so, by Proposition A5.1.8, there exists an open symmetric neighbourhood V of e such that $V^2 \subseteq G \setminus \{x^{-1}y\}$. Thus $x^{-1}y \notin V^2$.

Now xV and yV are open neighbourhoods of x and y , respectively. Suppose $xV \cap yV \neq \emptyset$. Then $xv_1 = yv_2$, where v_1 and v_2 are in V ; that is, $x^{-1}y = v_1v_2^{-1} \in V.V^{-1} = V^2$, which is a contradiction. Hence $xV \cap yV = \emptyset$ and so (G, \mathcal{T}) is Hausdorff. \square

A5.1.10 Remark. So to check that a topological group is Hausdorff it is only necessary to verify that each point is a closed set. Indeed, by Proposition A5.1.5, it suffices to show that $\{e\}$ is a closed set.

Warning. Many authors include "Hausdorff" in their definition of topological group.

A5.1.11 Remark. The vast majority of work on topological groups deals only with Hausdorff topological groups. (Indeed many authors include "Hausdorff" in their definition of topological group.) We will see one reason for this shortly. However, it is natural to ask: Does every group admit a Hausdorff topology which makes it into a topological group? The answer is obviously "yes"—the discrete topology. But we mention the following problem.

Question. Does every group admit a Hausdorff non-discrete group topology which makes it into a topological group?

Shelah [194] provided a negative answer, under the assumption of the continuum hypothesis. However in the special case that the group is abelian (that is, commutative) the answer is "yes" and we shall prove this soon. \square

Exercises A5.1

1. Let (G, \mathcal{T}) be a topological group, e its identity element, and k any element of G . If U is any neighbourhood of e , show that there exists an open neighbourhood V of e such that
 - (i) $V = V^{-1}$,
 - (ii) $V^2 \subseteq U$, and
 - (iii) $kVk^{-1} \subseteq U$. (In fact, with more effort you can show that if K is any compact subset of (G, \mathcal{T}) then V can be chosen also to have the property: (iv) for any $k \in K$, $kVk^{-1} \subseteq U$.)

2. (i) Let G be any group and let $\mathcal{N} = \{N\}$ be a family of normal subgroups of G . Show that the family of all sets of the form gN , as g runs through G and N runs through \mathcal{N} is an open subbasis for a topological group topology on G . Such a topology is called a **subgroup topology**.
 - (ii) Prove that every topological group topology on a finite group is a subgroup topology with \mathcal{N} consisting of precisely one normal subgroup.

3. Show that
 - (ii) if (G, \mathcal{T}) is a topological group, then (G, \mathcal{T}) is a regular space;
 - (iii) any regular T_0 -space is Hausdorff, and hence any topological group which is a T_0 -space is Hausdorff.

4. Let (G, \mathcal{T}) be a topological group, A and B subsets of G and g any element of G . Show that
 - (i) If A is open, then gA is open.
 - (ii) If A is open and B is arbitrary, then AB is open.
 - (iii) If A and B are compact, then AB is compact.
 - (iv) If A is compact and B is closed, then AB is closed.
 - (v)* If A and B are closed, then AB need not be closed.

5. Let S be a compact subset of a metrizable topological group G , such that $xy \in S$ if x and y are in S . Show that for each $x \in S$, $xS = S$. (Let y be a cluster point of the sequence x, x^2, x^3, \dots in S and show that $yS = \bigcap_{n=1}^{\infty} x^n S$; deduce that $yxS = yS$.) Hence show that S is a subgroup of G . (Cf. Hewitt and Ross [100], Theorem 9.16.)

A5.2 Subgroups and Quotient of Topological Groups

A5.2.1 Definition. Let G_1 and G_2 be topological groups. A map $f : G_1 \rightarrow G_2$ is said to be a **continuous homomorphism** if it is both a homomorphism of groups and continuous. If f is also a homeomorphism then it is said to be a **topological group isomorphism** or a **topological isomorphism** and G_1 and G_2 are said to be **topologically isomorphic**.

A5.2.2 Example. Let \mathbb{R} be the additive group of real numbers with the usual topology and \mathbb{R}^\times the multiplicative group of positive real numbers with the usual topology. Then \mathbb{R} and \mathbb{R}^\times are topologically isomorphic, where the topological isomorphism $\mathbb{R} \rightarrow \mathbb{R}^\times$ is $x \mapsto e^x$. (Hence we need not mention this group \mathbb{R}^\times again, since, as topological groups, \mathbb{R} and \mathbb{R}^\times are the same.) \square

A5.2.3 Proposition. Let G be a topological group and H a subgroup of G . With its subspace topology, H is a topological group.

Proof. The mapping $(x, y) \mapsto xy$ of $H \times H$ onto H and the mapping $x \mapsto x^{-1}$ of H onto H are continuous since they are restrictions of the corresponding mappings of $G \times G$ and G . \square

A5.2.4 Examples. (i) $\mathbb{Z} \leq \mathbb{R}$; (ii) $\mathbb{Q} \leq \mathbb{R}$. \square

A5.2.5 Proposition. Let H be a subgroup of a topological group G . Then

- (i) the closure \overline{H} of H is a subgroup of G ;
- (ii) if H is a normal subgroup of G , then \overline{H} is a normal subgroup of G ;
- (iii) if G is Hausdorff and H is abelian, then \overline{H} is abelian.

Proof. Exercise □

A5.2.6 Corollary. Let G be a topological group. Then

- (i) $\overline{\{e\}}$ is a closed normal subgroup of G ; indeed, it is the smallest closed subgroup of G ;
- (ii) if $g \in G$, then $\overline{\{g\}}$ is the coset $g\overline{\{e\}} = \overline{\{e\}}g$;
- (iii) If G is Hausdorff then $\overline{\{e\}} = \{e\}$.

Proof. This follows immediately from Proposition A5.2.5 (ii) by noting that $\{e\}$ is a normal subgroup of G . □

A5.2.7 Proposition. Any open subgroup H of a topological group G is (also) closed.

Proof. Let $x_i, i \in I$ be a set of right coset representatives of H in G . So $G = \bigcup_{i \in I} Hx_i$, where $Hx_i \cap Hx_j = \emptyset$, for any distinct i and j in the index set I .

Since H is open, so is Hx_i open, for each $i \in I$.

Of course for some $i_0 \in I$, $Hx_{i_0} = H$, that is, we have $G = H \cup \left(\bigcup_{i \in J} Hx_i \right)$, where $J = I \setminus \{i_0\}$.

These two terms are disjoint and the second term, being the union of open sets, is open. So H is the complement (in G) of an open set, and is therefore closed in G . □

Note that the converse of Proposition A5.2.7 is false. For example, \mathbb{Z} is a closed subgroup of \mathbb{R} , but it is not an open subgroup of \mathbb{R} .

A5.2.8 Proposition. Let H be a subgroup of a Hausdorff group G . If H is locally compact, then H is closed in G . In particular this is the case if H is discrete.

Proof. Let K be a compact neighbourhood in H of e . Then there exists a neighbourhood U in G of e such that $U \cap H = K$. In particular, $U \cap H$ is closed in G . Let V be a neighbourhood in G of e such that $V^2 \subseteq U$.

If $x \in \overline{H}$, then as \overline{H} is a group (Proposition A5.2.5), $x^{-1} \in \overline{H}$. So there exists an element $y \in Vx^{-1} \cap H$. We will show that $yx \in H$. As $y \in H$, this will imply that $x \in H$ and hence H is closed, as required.

To show that $yx \in H$ we verify that yx is a limit point of $U \cap H$. As $U \cap H$ is closed this will imply that $yx \in U \cap H$ and so, in particular, $yx \in H$.

Let O be an arbitrary neighbourhood of yx . Then $y^{-1}O$ is a neighbourhood of x , and so $y^{-1}O \cap xV$ is a neighbourhood of x . As $x \in \overline{H}$, there is an element $h \in (y^{-1}O \cap xV) \cap H$. So $yh \in O$. Also $yh \in (Vx^{-1}(xV)) = V^2 \subseteq U$, and $yh \in H$; that is, $yh \in O \cap (U \cap H)$. As O is arbitrary, this says that yx is a limit point of $U \cap H$, as required. \square

A5.2.9 Proposition. Let U be a symmetric neighbourhood of e in a topological group G . Then $H = \bigcup_{n=1}^{\infty} U^n$ is an open (and closed) subgroup of G .

Proof. Clearly H is a subgroup of G .

Let $h \in H$. Then $h \in U^n$, for some n .

So $h \in hU \subseteq U^{n+1} \subseteq H$; that is, H contains the neighbourhood hU of h .

As h was an arbitrary element of H , H is open in G . It is also closed in G , by Proposition A5.2.7. \square

A5.2.10 Corollary. Let U be any neighbourhood of e in a connected topological group G . Then $G = \bigcup_{n=1}^{\infty} U^n$; that is, any connected group is generated by any neighbourhood of e .

Proof. Let V be a symmetric neighbourhood of e such that $V \subseteq U$. By Proposition A5.2.9, $H = \bigcup_{n=1}^{\infty} V^n$ is an open and closed subgroup of G .

As G is connected, $H = G$; that is $G = \bigcup_{n=1}^{\infty} V^n$.

As $V \subseteq U$, $V^n \subseteq U^n$, for each n and so $G = \bigcup_{n=1}^{\infty} U^n$, as required. \square

A5.2.11 Definition. A topological group G is said to be **compactly generated** if there exists a compact subset X of G such that G is the smallest subgroup (of G) containing X .

A5.2.12 Examples.

- (i) \mathbb{R} is compactly generated by $[0, 1]$ (or any other non-trivial compact interval).
- (ii) Of course, any compact group is compactly generated.

A5.2.13 Corollary. Any connected locally compact group is compactly generated.

Proof. Let K be any compact neighbourhood of e . Then by Corollary A5.2.10, $G = \bigcup_{n=1}^{\infty} K^n$; that is, G is compactly generated. \square

A5.2.14 Remark. In due course we shall describe the structure of compactly generated locally compact Hausdorff abelian groups. We now see that this class includes all connected locally compact Hausdorff abelian groups.

Notation. By **LCA-group** we shall mean locally compact Hausdorff abelian topological group.

A5.2.15 Proposition. The component of the identity (that is, the largest connected subset containing e) of a topological group is a closed normal subgroup.

Proof. Let C be the component of the identity in a topological group G . As in any topological space components are closed sets, C is closed.

Let $a \in C$. Then $a^{-1}C \subseteq C$, as $a^{-1}C$ is connected (being a homeomorphic image of C) and contains e .

So $\bigcup_{a \in C} a^{-1}C = C^{-1}C \subseteq C$, which implies that C is a subgroup.

To see that C is a normal subgroup, simply note that for each x in G , $x^{-1}Cx$ is a connected set containing e and so $x^{-1}Cx \subseteq C$. \square

A5.2.16 Proposition. Let N be a normal subgroup of a topological group G . If the quotient group G/N is given the quotient topology under the canonical homomorphism $p : G \rightarrow G/N$ (that is, U is open in G/N if and only if $p^{-1}(U)$ is open in G), then G/N becomes a topological group. Further, the map p is not only continuous but also open. (A map is said to be **open** if the image of every open set is open.)

Proof. The verification that G/N with the quotient topology is a topological group is routine. That the map p is continuous is obvious (and true for all quotient maps of topological spaces).

To see that p is an open map, let O be an open set in G . Then $p^{-1}(p(O)) = NO \subseteq G$. Since O is open, NO is open. (See Exercises A5.2 #4.) So by the definition of the quotient topology on G/N , $p(O)$ is open in G/N ; that is, p is an open map. \square

5.2.17 Remarks.

- (i) Note that quotient maps of topological spaces are not necessarily open maps.
- (ii) Quotient maps of topological groups are not necessarily closed maps. For example, if \mathbb{R}^2 denote the product group $\mathbb{R} \times \mathbb{R}$ with the usual topology, and p is the projection of \mathbb{R}^2 onto its first factor \mathbb{R} , then the set $S = \{(x, \frac{1}{x}) : x \in \mathbb{R}, x \neq 0\}$ is closed in \mathbb{R}^2 and p is a quotient map with $p(S)$ not closed in \mathbb{R} . \square

5.2.18 Proposition. If G is a topological group and N is a compact normal subgroup of G then the canonical homomorphism $p : G \rightarrow G/N$ is a closed map. The homomorphism p is also an open map.

Proof. If S is a closed subset of G , then $p^{-1}(p(S)) = NS$ which is the product in G of a compact set and a closed set. By Exercises 5.1 #4 then, this product is a closed set. So $p(S)$ is closed in G/N and p is a closed map. As p is a quotient mapping, Proposition 5.2.16 implies that it is an open map. \square

5.2.19 Definition. A topological space is said to be **totally disconnected** if the component of each point is the point itself.

5.2.20 Proposition. If G is any topological group and C is the component of the identity, then G/C is a totally disconnected topological group.

Proof. Note that C is a normal subgroup of G and so G/C is a topological group.

The proof that G/C is totally disconnected is left as an exercise. \square

5.2.21 Proposition. If G/N is any quotient group of a locally compact group G , then G/N is locally compact.

Proof. Simply observe that any open continuous image of a locally compact space is locally compact. \square

5.2.22 Proposition. Let G be a topological group and N a normal subgroup. Then G/N is discrete if and only if N is open. Also G/N is Hausdorff if and only if N is closed.

Proof. This is obvious (noting that a T_1 -group is Hausdorff). \square

Exercises A5.2

1. Let G and H be topological groups and $f : G \rightarrow H$ a homomorphism. Show that f is continuous if and only if it is continuous at the identity; that is, if and only if for each neighbourhood U in H of e , there exists a neighbourhood V in G of e such that $f(V) \subseteq U$.
2. Show that the circle group \mathbb{T} is topologically isomorphic to the quotient group \mathbb{R}/\mathbb{Z} .
3. Let B_1 and B_2 be (real) Banach spaces. Verify that
 - (i) B_1 and B_2 , with the topologies determined by their norms, are topological groups.
 - (ii) If $T : B_1 \rightarrow B_2$ is a continuous homomorphism (of topological groups) then T is a continuous linear transformation. (So if B_1 and B_2 are "isomorphic as topological groups" then they are "isomorphic as topological vector spaces" but not necessarily "isomorphic as Banach spaces".)

4. Let H be a subgroup of a topological group G . Show that H is open in G if and only if H has non-empty interior (that is, if and only if H contains a non-empty open subset of G).
5. Let H be a subgroup of a topological group G . Show that
 - (i) \overline{H} is a subgroup of G .
 - (ii) If H is a normal subgroup of G , then \overline{H} is a normal subgroup of G .
 - (iii) If G is Hausdorff and H is abelian, then \overline{H} is abelian.
6. Let Y be a dense subspace of a Hausdorff space X . If Y is locally compact, show that Y is open in X . Hence show that [a locally compact subgroup of a Hausdorff group is closed](#).
7. Let C be the component of the identity in a topological group G . Show that G/C is a Hausdorff totally disconnected topological group. Further show that if f is any continuous homomorphism of G into any totally disconnected topological group H , then there exists a continuous homomorphism $g : G/C \rightarrow H$ such that $gp = f$, where p is the projection $p : G \rightarrow G/C$.
8. Show that the commutator subgroup $[G, G]$ of a connected topological group G is connected. ($[G, G]$ is generated by $\{g_1^{-1}g_2^{-1}g_1g_2 : g_1, g_2 \in G\}$.)
9. If H is a totally disconnected normal subgroup of a connected Hausdorff group G , show that H lies in the centre, $Z(G)$, of G (that is, $gh = hg$, for all $g \in G$ and $h \in H$).
(Hint: Fix $h \in H$ and observe that the map $g \mapsto ghg^{-1}$ takes G into H .)

10. (i) Let G be any topological group. Verify that $G/\overline{\{e\}}$ is a Hausdorff topological group. Show that if H is any Hausdorff group and $f : G \rightarrow H$ is a continuous homomorphism, then there exists a continuous homomorphism $g : G/\overline{\{e\}} \rightarrow H$ such that $gp = f$, where p is the canonical map $p : G \rightarrow G/\overline{\{e\}}$.

(This result is the usual reason given for studying Hausdorff topological groups rather than arbitrary topological groups. However, the following result which says in effect that all of the topology of a topological group lies in its "Hausdorffization", namely $G/\overline{\{e\}}$, is perhaps a better reason.)

- (ii) Let G_i denote the group G with the indiscrete topology and $i : G \rightarrow G_i$ the identity map. Verify that the map $p \times i : G \rightarrow G/\overline{\{e\}} \times G_i$, given by $p \times i(g) = (p(g), i(g))$, is a topological group isomorphism of G onto its image $p \times i(G)$.

11. Show that every Hausdorff group, H , is topologically isomorphic to a closed subgroup of an arcwise connected, locally arcwise connected Hausdorff group G . (Consider the set G of all functions $f : [0, 1) \rightarrow H$ such that there is a sequence $0 = a_0 < a_1 < a_2 < \dots < a_n = 1$ with f being constant on each $[a_k, a_{k+1})$. Define a group structure on G by $fg(t) = f(t)g(t)$ and $f^{-1}(t) = (f(t))^{-1}$, where f and $g \in G$ and $t \in [0, 1)$. The identity of G is the function identically equal to e in H . For $\varepsilon > 0$ and any neighbourhood V of e in H let $U(V, \varepsilon)$ be the set of all f such that $\lambda(\{t \in [0, 1) : f(t) \notin V\}) < \varepsilon$, where λ is Lebesgue measure on $[0, 1)$. The set of all $U(V, \varepsilon)$ is an open basis for a group topology on G . The constant functions form a closed subgroup of G topologically isomorphic to H .)

A5.3 Embedding in Divisible Groups

A5.3.1 Remark. Products of topological spaces are discussed in detail in Chapters 8, 9 and 10. The most important result on products is, of course, Tychonoff's Theorem 10.3.4 which says that any (finite or infinite) product (with the product topology) of compact topological spaces is compact. Further, Theorem 10.3.4 says that a product of topological spaces $\{(X_i, \mathcal{T}_i) : i \in I\}$ is compact only if each of the spaces (X_i, \mathcal{T}_i) is compact.

If each G_i is a group then $\prod_{i \in I} G_i$ has the obvious group structure $(\prod_{i \in I} g_i \cdot \prod_{i \in I} h_i = \prod_{i \in I} (g_i h_i))$, where g_i and $h_i \in G_i$.

If $\{G_i : i \in I\}$ is a family of groups then the **restricted direct product (weak direct product)**,

denoted $\prod_{i \in I}^r G_i$, is the subgroup of $\prod_{i \in I} G_i$ consisting of elements $\prod_{i \in I} g_i$, with $g_i = e$, for all but a finite number of $i \in I$.

From now on, if $\{G_i : i \in I\}$ is a family of topological groups then $\prod_{i \in I} G_i$ will denote the direct product with the product topology. Further $\prod_{i \in I}^r G_i$ will denote the restricted direct product with the topology induced as a subspace of $\prod_{i \in I} G_i$. \square

A5.3.2 Proposition. If each G_i , $i \in I$ is a topological group, then $\prod_{i \in I} G_i$ is a topological group. Further $\prod_{i \in I}^r G_i$ is a dense subgroup of $\prod_{i \in I} G_i$.

Proof. Exercise. □

A5.3.3 Proposition. Let $\{G_i : i \in I\}$ be a family of topological groups. Then

- (i) $\prod_{i \in I} G_i$ is locally compact if and only if each G_i is locally compact and all but a finite number of G_i are compact.
- (ii) $\prod_{i \in I}^r G_i$ is locally compact Hausdorff if and only if each G_i is locally compact Hausdorff and $G_i = \{e\}$ for all but a finite number of G_i .

Proof. Exercise. □

To prove the result we foreshadowed: *every infinite abelian group admits a non-discrete Hausdorff group topology* we need some basic group theory.

A5.3.4 Definition. A group D is said to be **divisible** if for each $n \in \mathbb{N}$, $\{x^n : x \in D\} = D$; that is, every element of D has an n^{th} root.

A5.3.5 Examples. It is easily seen that the groups \mathbb{R} and \mathbb{T} are divisible, but the group \mathbb{Z} is not divisible. □

A5.3.6 Proposition. Let H be a subgroup of an abelian group G . If ϕ is any homomorphism of H into a divisible abelian group D , then ϕ can be extended to a homomorphism Φ of G into D .

Proof. By Zorn's Lemma 10.2.16, it suffices to show that if $x \notin H$, ϕ can be extended to the group $H_0 = \{x^n h : h \in H, n \in \mathbb{Z}\}$.

Case (i). Assume $x^n \notin H$, $n \in \mathbb{N}$. Then define $\Phi(x^n h) = \phi(h)$, for all $n \in \mathbb{Z}$. Clearly Φ is well-defined, a homomorphism, and extends ϕ on H .

Case (ii). Let $k \geq 2$ be the least positive integer n such that $x^n \in H$. So $\phi(x^k) = d \in D$. As D is divisible, there is a $z \in D$ such that $z^k = d$. Define $\Phi(x^n h) = \phi(h)z^n$, for all $n \in \mathbb{Z}$. Clearly Φ is well-defined, a homomorphism and extends ϕ on H . \square

A5.3.7 Corollary. If G is an abelian group, then for any g and h in G , with $g \neq h$, there exists a homomorphism $\phi : G \rightarrow \mathbb{T}$ such that $\phi(g) \neq \phi(h)$; that is, ϕ separates points of G .

Proof. Clearly it suffices to show that for each $g \neq e$ in G , there exists a homomorphism $\phi : G \rightarrow \mathbb{T}$ such that $\phi(g) \neq e$.

Case (i). Assume $g^n = e$, and $g^k \neq e$ for $0 < k < n$. Let $H = \{g^m : m \in \mathbb{Z}\}$. Define $\phi : H \rightarrow \mathbb{T}$ by $\phi(g) = \text{an } n^{\text{th}} \text{ root of unity} = r$, say, ($r \neq e$), and $\phi(g^m) = r^m$, for each m . Now extend ϕ to G by Proposition A5.3.6.

Case (ii). Assume $g^n \neq e$, for all $n > 0$. Define $\phi(g) = z$, for any $z \neq e$ in \mathbb{T} . Extend ϕ to H and then, by Proposition A5.3.6, to G . \square

For later use we also record the following corollary of Proposition A5.3.6.

A5.3.8 Proposition. Let H be an open divisible subgroup of an abelian topological group G . Then G is topologically isomorphic to $H \times G/H$. (Clearly G/H is a discrete topological group.)

Proof. Exercise. \square

A5.3.9 Theorem. If G is any infinite abelian group, then G admits a non-discrete Hausdorff group topology.

Proof. Let $\{\phi_i : i \in I\}$ be the family of distinct homomorphisms of G into \mathbb{T} . Put $H = \prod_{i \in I} T_i$, where each $T_i = \mathbb{T}$. Define a map $f : G \rightarrow H = \prod_{i \in I} T_i$ by putting $f(g) = \prod_{i \in I} \phi_i(g)$. Since each ϕ_i is a homomorphism, f is also a homomorphism. By Corollary A5.3.7, f is also one-one; that is, G is isomorphic to the subgroup $f(G)$ of H .

As H is a Hausdorff topological group, $f(G)$, with the topology induced from H , is also a Hausdorff topological group. It only remains to show that $f(G)$ is not discrete.

Suppose $f(G)$ is discrete. Then, by Proposition A5.2.8, $f(G)$ would be a closed subgroup of H . But by Tychonoff's Theorem 10.3.4, H is compact and so $f(G)$ would be compact; that is, $f(G)$ would be an infinite discrete compact space—which is impossible. So we have a contradiction, and thus $f(G)$ is not discrete. \square

A5.3.10 Remark. Corollary A5.3.7 was essential to the proof of Theorem A5.3.9. This Corollary is a special case of a more general theorem which will be discussed later. We state the result below.

A5.3.11 Theorem. If G is any LCA-group, then for any g and h in G , with $g \neq h$, there exists a continuous homomorphism $\phi : G \rightarrow \mathbb{T}$ such that $\phi(g) \neq \phi(h)$.

Exercises A5.3

1. If $\{G_i : i \in I\}$ is a family of topological groups, show that
 - (i) $\prod_{i \in I} G_i$ is a topological group;
 - (ii) $\prod_{i \in I}^r G_i$ is a dense subgroup of $\prod_{i \in I} G_i$;
 - (iii) $\prod_{i \in I} G_i$ is locally compact if and only if each G_i is locally compact and all but a finite number of G_i are compact;
 - (iv) $\prod_{i \in I}^r G_i$ is locally compact Hausdorff if and only if each G_i is locally compact Hausdorff and $G_i = \{e\}$ for all but a finite number of G_i .

2. Show that if G is an abelian topological group with an open divisible subgroup H , then G is topologically isomorphic to $H \times G/H$.

3. Let G be a torsion-free abelian group (that is, $g^n \neq e$ for each $g \neq e$ in G , and each $n \in \mathbb{N}$). Show that if g and h are in G with $g \neq h$, then there exists a homomorphism ϕ of G into \mathbb{R} such that $\phi(g) \neq \phi(h)$.

4. Let G be a locally compact totally disconnected topological group.
 - (i) Show that there is a neighbourhood base of the identity consisting of compact open subgroups.
(Hint: You may assume that any locally compact Hausdorff totally disconnected topological space has a base for its topology consisting of compact open sets.)
 - (ii) If G is compact, show that the "subgroups" in (i) can be chosen to be normal.
 - (iii) Hence show that any compact totally disconnected topological group is topologically isomorphic to a closed subgroup of a product of finite discrete groups.
(Hint: Let $\{A_i : i \in I\}$ be a base of neighbourhoods of the identity consisting of open normal subgroups. Let $\phi_i : G \rightarrow G/A_i$, $i \in I$, be the canonical homomorphisms, and define $\Phi : G \rightarrow \prod_{i \in I} (G/A_i)$ by putting $\Phi(g) = \prod_{i \in I} \phi_i(g_i)$.)

5. Let $f : \mathbb{R} \rightarrow \mathbb{T}$ be the canonical map and θ any irrational number. On the topological space $G = \mathbb{R}^2 \times \mathbb{T}^2$ define an operation.

$$(x_1, x_2, t_1, t_2) \cdot (x'_1, x'_2, t'_1, t'_2) = (x_1 + x'_1, x_2 + x'_2, t_1 + t'_1 + f(x_2 x'_1), t_2 + t'_2 + f(\theta x_2 x'_1)).$$

Show that, with this operation, G is a topological group and that the commutator subgroup of G is not closed in G . (The commutator subgroup of a group G is the subgroup of G generated by the set $\{g^{-1}h^{-1}gh : g, h \in G\}$.)

6. Let I be a set directed by a partial ordering \geq . For each $i \in I$, let there be given a Hausdorff topological group G_i . Assume that for each i and j in I such that $i < j$, there is an open continuous homomorphism f_{ji} of G_j into G_i . Assume further that if $i < j < k$, then $f_{ki} = f_{ji} \circ f_{kj}$. The object consisting of I , the groups G_i and the mappings f_{ji} , is called an **inverse mapping system** or a **projective mapping system**. The subset H of the product group $G = \prod_{i \in I} G_i$ consisting of all $\prod_{i \in I} (x_i)$ such that if $i < j$ then $x_i = f_{ji}(x_j)$ is called the injective limit or **projective limit** of the inverse mapping system. Show that H is a closed subgroup of G .

A5.4 Baire Category and Open Mapping Theorems

A5.4.1 Theorem. (Baire Category Theorem for Locally Compact Spaces) If X is a locally compact regular space, then X is not the union of a countable collection of closed sets all having empty interior.

Proof. Suppose that $X = \bigcup_{n=1}^{\infty} A_n$, where each A_n is closed and $\text{Int}(A_n) = \emptyset$, for each n . Put $D_n = X \setminus A_n$. Then each D_n is open and dense in X . We shall show that $\bigcap_{n=1}^{\infty} D_n \neq \emptyset$, contradicting the equality $X = \bigcup_{n=1}^{\infty} A_n$.

Let U_0 be a non-empty open subset of X such that $\overline{U_0}$ is compact. As D_1 is dense in X , $U_0 \cap D_1$ is a non-empty open subset of X . Using the regularity of X we can choose a non-empty open set U_1 such that $\overline{U_1} \subseteq U_0 \cap D_1$. Inductively define U_n so that each U_n is a non-empty open set and $\overline{U_n} \subseteq U_{n-1} \cap D_n$. Since $\overline{U_0}$ is compact and each $\overline{U_n}$ is non-empty, $\bigcap_{n=1}^{\infty} \overline{U_n} \neq \emptyset$. This implies $\bigcap_{n=1}^{\infty} D_n \neq \emptyset$. This contradicts the supposition is false and so the theorem is proved. \square

A5.4.2 Remark. We saw that the Baire Category Theorem was proved for complete metric spaces in Theorem 6.5.1. The above Theorem also remains valid if "locally compact regular" is replaced by "locally compact Hausdorff".

A5.4.3 Corollary. Let G be any countable locally compact Hausdorff topological group. Then G has the discrete topology.

Proof. Exercise. □

A5.4.4 Theorem. (Open Mapping Theorem for Locally Compact Groups) Let G be a locally compact group which is σ -compact; that is, $G = \bigcup_{n=1}^{\infty} A_n$, where each A_n is compact. Let f be any continuous homomorphism of G onto a locally compact Hausdorff group H . Then f is an open mapping.

Proof. Let \mathcal{U} be the family of all symmetric neighbourhoods of e in G and \mathcal{U}' the family of all neighbourhoods of e in H . It suffices to show that for every $U \in \mathcal{U}$ there is a $U' \in \mathcal{U}'$ such that $U' \subseteq f(U)$.

Let $U \in \mathcal{U}$. Then there exists a $V \in \mathcal{U}$ having the property that \bar{V} is compact and $(\bar{V})^{-1}\bar{V} \subseteq U$. The family of sets $\{xV : x \in G\}$ is then an open cover of G and hence also of each compact set A_n . So a finite collection of these sets will cover any given A_n . So a finite collection of these sets will cover any given A_n . Thus there is a countable collection $\{x_n V : n \in \mathbb{N}\}$ which covers G .

So $H = \bigcup_{n=1}^{\infty} f(x_n V) = \bigcup_{n=1}^{\infty} f(x_n \bar{V}) = \bigcup_{n=1}^{\infty} f(x_n) f(\bar{V})$. This expresses H as a countable union of closed sets, and by the Baire Category Theorem 5.4.1, one of them must have non-empty interior; that is, $f(x_m) f(\bar{V})$ contains an open set. Then $f(\bar{V})$ contains an open subset V' of H .

To complete the proof select any point x' of V' and put $U' = (x')^{-1}V'$. Then we have

$$U' = (x')^{-1}V' \subseteq (V')^{-1}V' \subseteq (f(\bar{V}))^{-1}f(\bar{V}) = f((\bar{V})^{-1}\bar{V}) \subseteq f(U),$$

as required. □

A5.4.5 Remark. We met the Open mapping Theorem for Banach Spaces in Theorem 6.5.5

Exercises A5.4

1. Show that any countable locally compact Hausdorff group has the discrete topology.
2. Show that the Open Mapping Theorem A5.4.4 does not remain valid if either of the conditions “ σ -compact” or “onto” is deleted.

3. Show that any continuous homomorphism of a compact group onto a Hausdorff group is an open mapping.
4. Show that for any $n \in \mathbb{N}$, the compact topological group \mathbb{T}^n is topologically isomorphic to the quotient group $\mathbb{R}^n / \mathbb{Z}^n$.

5. (i) Let ϕ be a homomorphism of a topological group G into a topological group H . If X is a non-empty subset of G such that the restriction $\phi : X \rightarrow H$ is an open map, show that $\phi : G \rightarrow H$ is also an open map.

(Hint: For any subset U of G , $\phi(U) = \bigcup_{g \in G} \phi(U \cap gX)$.)

- (ii) Hence show that if G and H are locally compact Hausdorff groups with ϕ a continuous homomorphism $: G \rightarrow H$ such that for some compact subset K of G , $\phi(K)$ generates H algebraically, then ϕ is an open map.

(Hint: Show that there is a compact neighbourhood U of e such that $K \subseteq U$. Put $X =$ the subgroup generated algebraically by U .)

6. Let G and H be topological groups, and let η be a homomorphism of H into the group of automorphisms of G . Define a group structure on the set $G \times H$ by putting

$$(g_1, h_1) \cdot (g_2, h_2) = (g_1 \eta(h_1)(g_2), h_1 h_2).$$

Further, let $(g, h) \mapsto \eta(h)(g)$ be a continuous map of $G \times H$ onto G . Show that

- (i) Each $\eta(h)$ is a homeomorphism of G onto itself; and
- (ii) With the product topology and this group structure $G \times H$ is a topological group. (It is called the **semidirect product** of G by H that is determined by η , and is denoted by $G \rtimes_{\eta} H$.)
7. (i) Let G be a σ -compact locally compact Hausdorff topological group with N a closed normal subgroup of G and H a closed subgroup of G such that $G = NH$ and $N \cap H = \{e\}$. Show that G is topologically isomorphic to an appropriately defined semidirect product $N \rtimes_{\eta} H$.
- (Hint: Let $\eta(h)(n) = h^{-1}nh$, $h \in H$ and $n \in N$.)
- (ii) If H is also normal, show that G is topologically isomorphic to $N \times H$.
- (iii) If A and B are closed compactly generated subgroups of a locally compact Hausdorff abelian topological group G such that $A \cap B = \{e\}$ and $G = AB$, show that G is topologically isomorphic to $A \times B$.

8. Let G and H be Hausdorff topological groups and f a continuous homomorphism of G into H . If G has a neighbourhood U of e such that \bar{U} is compact and $f(U)$ is a neighbourhood of e in H , show that f is an open map.

Bibliography

- [1] Colin C. Adams. *The knot book: an elementary introduction to the mathematical theory of knots*. Freeman and Co., New York, 1994.
- [2] J. Frank Adams. *Algebraic topology: a student's guide*. Cambridge University Press, Cambridge, England, 1972.
- [3] G.N. Afanasiev. *Topological effects in quantum mechanics*. Kluwer Academic Publishers, Dordrecht, Boston, 1999.
- [4] M.A. Aguilar, S. Gitler, and C. Prieto. *Algebraic topology from a homotopical viewpoint*. Springer, New York, 2002.
- [5] Paul S. Alexandroff and Heinz Hopf. *Topologie*. Springer-Verlag, Berlin, 1935.
- [6] *Algebraic and Geometric Topology*. <http://www.maths.warwick.ac.uk/agt>, 2001–. a refereed electronic journal.
- [7] Charilaos N. Anziris. *The mystery of knots: computer programming for knot tabulation*. World Scientific Publishers, Singapore; River Edge, N.J., 1999.
- [8] A.V. Arkhangel'skiĭ. *Fundamentals of general topology: problems and exercises*. Kluwer, Boston, 1984.
- [9] A.V. Arkhangel'skiĭ. *Topological function spaces*. Kluwer, Boston, 1992.
- [10] A.V. Arkhangel'skiĭ and L.S. Pontryagin, editors. *General Topology I*. Springer-Verlag, Berlin etc., 1990.
- [11] D.L. Armacost. *The structure of locally compact abelian groups*. M. Dekker, New York, 1981.

- [12] M.A. Armstrong. *Basic topology*. Springer-Verlag, New York, 1983.
- [13] V.I. Arnold and B.A. Khesin. *Topological methods in hydrodynamics*. Springer, New York, 1999.
- [14] Emil Artin. *Introduction to algebraic topology*. C.E. Merrill Publishing Co., Columbus, Ohio, 1969.
- [15] C.E. Aull and R. Lowen, editors. *Handbook of the history of general topology*. Kluwer Academic Publishers, Dordrecht; Boston, 1997.
- [16] Wojciech Banaszczyk. *Additive subgroups of topological vector spaces*. Springer-Verlag, Berlin; New York, 1991.
- [17] J. Banks, G. Davis, P. Stacey, J. Brooks, and G. Cairns. On devaney's definition of chaos. *Amer. Math. Monthly*, 99:332–334, 1992.
- [18] John Banks, Valentina Dragan, and Arthur Jones. *Chaos: A Mathematical Introduction*. Cambridge University Press, Cambridge, UK, 2003.
- [19] Dennis Barden and Charles Benedict Thomas. *Additive subgroups of topological vector spaces*. Imperial College Press, London, 2003.
- [20] Stephen Barr. *Experiments in topology*. Dover Publications, New York, 1989.
- [21] Gerald Alan Beer. *Topologies on closed and convex sets*. Kluwer Academic Publishers, Dordrecht, Boston, 1993.
- [22] Martin P. Bendsoe. *Optimization of structural topology*. Springer, Berlin, New York, 1995.
- [23] Martin P. Bendsoe. *Topology, optimization: theory, methods and applications*. Springer, Berlin, New York, 2003.
- [24] Czeslaw Bessaga and Aleksander Pelczynski. *Selected topics in infinite-dimensional topology*. PWN-Polish Scientific Publishers, Warsaw, 1975.
- [25] G.D. Birkhoff and P.A. Smith. Structure analysis of surface transformations. *Jour. Math (Liouville)*, (9) 7:345–379, 1928.

- [26] Donald W. Blakett. *Elementary topology; a combinatorial and algebraic approach*. Academic Press, New York, 1967.
- [27] Danail Bonchev and Dennis H. Rouvray, editors. *Chemical topology : introduction and fundamental*. Gordon and Breach, Amsterdam, 1999.
- [28] Armand Borel. *Seminars on transformation groups*. Princeton University Press, Princeton, N.J., 1960.
- [29] Karol Borsuk. *Collected Papers/ Karol Borsuk*. PWN-Polish Scientific Publishers, Warsaw, 1983.
- [30] Nicolas Bourbaki. *General topology v.1 & v.2*. Addison-Wesley, Reading, Mass., 1966.
- [31] Nicolas Bourbaki. *Topologie générale, Chap. 1-4 and Chap. 5-10*. Hermann, Paris, 1971 and 1974.
- [32] Nicolas Bourbaki. *Topological vector spaces*. Springer-Verlag, Berlin ; New York, 1987.
- [33] Glen E. Bredon. *Topology and geometry*. Springer, New York, 1997.
- [34] Robert F. Brown. *The Lefschetz fixed point theorem*. Scott, Foresman, Glenview, Ill., 1971.
- [35] Ronald Brown. *Elements of modern topology*. McGraw Hill, New York, 1968.
- [36] Ronald Brown. *Topology : a geometric account of general topology, homotopy types, and the fundamental groupoid*. Halstead Press, New York, 1988.
- [37] Georg Cantor. *Contributions to the founding of the theory of transfinite numbers, by Georg Cantor; tr., and provided with an introduction and notes, by Philip E.B. Jourdain*. The Open Court Publishing Company, Chicago, London, 1915.
- [38] Stephen C. Carlson. *Topology of surfaces, knots, and manifolds: a first undergraduate course*. Wiley, New York, 2001.
- [39] J. Scott Carter. *How surfaces intersect in space : an introduction to topology*. World Scientific Publishers, Singapore ; River Edge, N.J., 1995.
- [40] Eduard Čech. *Topological spaces*. Czechoslovak Academy of Sciences, Prague, 1966.
- [41] Eduard Čech. *Point sets*. Czechoslovak Academy of Sciences, Prague, 1969.

- [42] Graciela Chichilnisky. *Topology and markets*. American Mathematical society, Providence, R.I., 1999.
- [43] Gustave Choquet. *Topology*. Academic Press, New York, 1966.
- [44] Gustave Choquet. *Lectures on analysis*. W.A. Benjamin, New York, 1969.
- [45] Daniel E. Cohen. *Combinatorial group theory: a topological approach*. Cambridge University Press, Cambridge; New York, 1989.
- [46] W.W. Comfort and S. Negrepointis. *The theory of ultrafilters*. Springer-Verlag, Berlin, New York, 1974.
- [47] W.W. Comfort and S. Negrepointis. *Continuous pseudometrics*. M. Dekker, New York, 1975.
- [48] W.W. Comfort and S. Negrepointis. *Chain conditions in topology*. Cambridge University Press, Cambridge, England; New York, 1982.
- [49] James P. Corbett. *Topological principles in cartography*. US Department of Commerce, Washington, D.C., 1980.
- [50] J.-M. Cordier. *Shape theory: categorical methods of approximation*. Halstead Press, Chichester, England; New York, 1989.
- [51] Jane Cronin. *Fixed points and topological degree in nonlinear analysis*. American Mathematical Society, Providence, R.I., 1964.
- [52] R.J. Daverman and R.B. Sher, editors. *Handbook of geometric topology*. Elsevier, Amsterdam; New York, 2002.
- [53] H. de Vries. *Compact spaces and compactifications: an algebraic approach*. Van Gorcum, Assen, 1962.
- [54] J.V. Deshpande. *Introduction to topology*. Tata McGraw-Hill Publishing Company Limited, New Delhi, New York, etc., 1988.
- [55] Robert L. Devaney. *Chaos, fractals and dynamics: computer experiments in mathematics*. Addison-Wesley, Menlo Park, California, 1990.

- [56] Robert L. Devaney. *A first course in chaotic dynamical systems: theory and experiment*. Westview Press, Boulder, Colorado, 1992.
- [57] Robert L. Devaney. *An Introduction to Chaotic Dynamical Systems, 2nd Edition*. Westview Press, Boulder, Colorado, 2003.
- [58] Tammo tom Dieck. *Topologie*. de Gruyter, Berlin, 2000.
- [59] Egbert Dierker. *Topological methods in Walrasian economics*. Springer-Verlag, Berlin; New York, 1974.
- [60] Jean Alexandre Dieudonné. *A history of algebraic and differential topology, 1900-1960*. Birkhauser, Boston, 1989.
- [61] Dikran N. Dikranjan. *Categorical structure of closure operators with applications to topology, algebra and discrete mathematics*. Kluwer Academic Publishers, Dordrecht, Boston, 1995.
- [62] Mircea V. Diudea and L. Jantschi. *Molecular topology*. Nova Science Publishers, Huntington, N.Y., 2001.
- [63] C.T.J. Dodson. *Category bundles and spacetime topology*. Kluwer Academic Publishers, Dordrecht, Boston, 1988.
- [64] C.T.J. Dodson. *A user's guide to algebraic topology*. Kluwer Academic Publishers, Dordrecht, Boston, 1997.
- [65] Albrecht Dold. *Lectures on algebraic topology*. Springer, Berlin, 1995.
- [66] James Dugundji. *Topology*. Allyn and Bacon, Boston, 1966.
- [67] Alan Dunn. *Sarkovskii's Theorem—Part 1*, <http://ocw.mit.edu/nr/rdonlyres/mathematics/18-091spring-2005/a335fb2e-7381-49d4-b60c-7cbd2f349595/0/sarkcomplete.pdf>, 2005.
- [68] Herbert Edelsbrunner. *Geometry and topology for mesh generation*. Cambridge University Press, Cambridge; New York, 2001.
- [69] Gerald A. Edgar. *Measure, topology and fractal geometry*. Springer-Verlag, New York, 1990.

- [70] R.E. Edwards. *Curves and topological questions*. Australian National University, Canberra, Australia, 1969.
- [71] Robert E. Edwards. *Functional analysis: theory and applications*. Holt, Rinehart and Winston, N.Y., 1965.
- [72] James Eels. *Singularities of smooth maps*. Gordon and Breach, New York, 1967.
- [73] Samuel Eilenberg and Norman Steenrod. *Foundations of algebraic topology*. Princeton University Press, Princeton, N.J., 1952.
- [74] Murray Eisenberg. *Topology*. Holt, Rinehart and Winston, New York, 1974.
- [75] Patrik Eklund. *Categorical fuzzy topology*. Abo Akademi, Abo, 1986.
- [76] Glenn Elert. *The Chaos Hypertextbook*, <http://hypertextbook.com/chaos/>, 2003.
- [77] Ryszard Engelking. *General topology*. PWN – Polish Scientific Publishers, Warsaw, 1977.
- [78] Ryszard Engelking. *Dimension theory*. North-Holland Publishing Co., Amsterdam; New York, 1978.
- [79] William W. Fairchild and Cassius Ionescu Tulceac. *Topology*. W.B. Saunders Company, Philadelphia, London, Toronto, 1971.
- [80] K.J. Falconer. *Fractal geometry: mathematical foundations and applications*. Wiley, Chichester, New York, 1990.
- [81] Erica Flapan. *When topology meets chemistry: a topological look at molecular chirality*. Cambridge University Press, Cambridge; New York, 2000.
- [82] Graham Flegg. *From geometry to topology*. Dover Publications, Mineola, N.Y., 2001.
- [83] D.H. Fremlin. *Consequences of Martin's Axioms*. Cambridge University Press, Cambridge; New York, 1984.
- [84] Robert Froman. *Rubber bands, baseballs and doughnuts; a book about topology. Illustrated by Harvey Weiss*. Crowell, New York, 1972.
- [85] P.M. Gadea and J. Munoz Masque. *Analysis and algebra on differentiable manifolds: a workbook for students and teachers*. Kluwer Academic Publishers, Dordrecht, 2001.

- [86] David B. Gauld. *Differential topology: an introduction*. M. Dekker, New York, 1982.
- [87] *General Topology Front for the Mathematics ArXiv*.
<http://front.math.ucdavis.edu/math.gn>, 1992–. Los Alamos National Laboratory e-Print archive.
- [88] Gerhard Gierz, K.H. Hofmann, K. Keimel, J.D. Lawson, M.W Mislove, and D.S. Scott. *A compendium of continuous lattices*. Springer-Verlag, Berlin, Heidelberg, New York, 1980.
- [89] Gerhard Gierz, K.H. Hofmann, K. Keimel, J.D. Lawson, M.W Mislove, and D.S. Scott. *Continuous lattices and domains*. Cambridge University Press, Cambridge, 2003.
- [90] Leonard Gillman and Meyer Jerison. *Rings of continuous functions*. Springer-Verlag, New York, 1976.
- [91] Robert Gilmore and Marc Lefranc. *The topology of chaos: Alice in stretch and squeezeland*. Wiley-Interscience, New York, 2002.
- [92] Norman J. Girardot. *Myth and Meaning in Early Taoism: The Theme of Chaos (hun-tun)*. University of California Press, Berkeley, California, 1983.
- [93] H. Brian Griffiths. *Surfaces*. Cambridge University Press, London; New York, 1976.
- [94] Jonathan L. Gross. *Topological graph theory*. Wiley, New York, 1987.
- [95] A. Grothendieck. *Topological vector spaces*. Gordon and Breach, New York, 1973.
- [96] Paul Halmos. *Naïve set theory*. Van Nostrand Reinhold Company, New York, Cincinnati, 1960.
- [97] Felix Hausdorff. *Set Theory (translated from the original German)*. Chelsea, New York, 1962.
- [98] Felix Hausdorff. *Grundzüge der Mengenlehre (reprint; originally published in Leipzig in 1914)*. Chelsea, New York, 1965.
- [99] Horst Herrlich and Hans-E. Porst, editors. *Category theory at work*. Heldermann-Verlag, Berlin, 1991.

- [100] Edwin Hewitt and Kenneth A. Ross. *Abstract harmonic analysis I: structure of topological groups, integration theory, group representations*. Springer-Verlag, Berlin, 1963.
- [101] Edwin Hewitt and Kenneth A. Ross. *Abstract harmonic analysis II: structure and analysis for compact groups, analysis on locally compact abelian groups*. Springer-Verlag, Berlin, 1970.
- [102] Joachim Hilgert, Karl Heinrich Hofmann, and Jimmie D. Lawson. *Lie groups, convex cones and semigroups*. Clarendon Press, Oxford, 1997.
- [103] Peter John Hilton. *Homology theory: an introduction to algebraic topology*. Cambridge University Press, London, 1967.
- [104] Neil Hindman and Dona Strauss. *Algebra in the Stone-Cech compactification : theory and applications*. W. de Gruyter, New York, 1998.
- [105] Morris W. Hirsch, Stephen Smale, and Robert L. Devaney. *Differential Equations, Dynamical Systems, and an Introduction to Chaos, 2nd Edition*. Elsevier, Oxford, UK, 2004.
- [106] John Gilbert Hocking and Gail S. Young. *Topology*. Addison-Wesley Publishing Co., Reading, Mass, 1961.
- [107] Karl H. Hofmann and Sidney A. Morris. *The Structure of Compact Groups: A Primer for the Student – A Handbook for the Expert*. de Gruyter, Studies in Mathematics 25, Berlin, second revised and augmented edition, 2006.
- [108] Karl H. Hofmann and Sidney A. Morris. *The Lie Theory of Connected Pro-Lie Groups: A Structure Theory for Pro-Lie Algebras, Pro-Lie Groups, and Connected Locally Compact Groups*. European Mathematical Society Publishing House, Tracts in Mathematics 2, Zurich, Switzerland, 2007.
- [109] Karl Heinrich Hofmann and Paul S. Mostert. *Elements of compact semigroups*. C.E. Merrill Books, Columbus, Ohio, 1966.
- [110] *Hopf Topology Archive*. <http://hopf.math.purdue.edu>, 1996–. Purdue University Hopf Archive of Topology preprints.

- [111] Juan Horváth. *Topological vector spaces and distributions*. Addison-Wesley, Reading, Mass., 1966.
- [112] Norman R. Howes. *Modern analysis and topology*. Springer-Verlag, New York, 1995.
- [113] S.T. Hu. *Introduction to general topology*. Holden-Day, San Francisco, 1966.
- [114] S.T. Hu. *Differentiable manifolds*. Holt, Rinehart and Winston, New York, 1969.
- [115] Sze-Tsen Hu. *Elements of general topology*. Holden-Day, San Francisco, 1964.
- [116] Sze-Tsen Hu. *Homology theory; a first course in algebraic topology*. Holden-Day, San Francisco, 1966.
- [117] Witold Hurewicz and Witold Wallman. *Dimension theory*. Princeton University Press, Princeton, N.J., 1941.
- [118] Taqdir Husain. *The open mapping and closed graph theorems in topological vector spaces*. Clarendon Press, Oxford, 1965.
- [119] Taqdir Husain. *Introduction to topological groups*. W.B. Saunders, Philadelphia, 1966.
- [120] Taqdir Husain. *Topology and maps*. Plenum Press, New York, 1977.
- [121] Miroslav Husek and Jan Van Mill. *Recent progress in general topology*. North-Holland, Amsterdam; New York, 1992.
- [122] J.R. Isbell. *Uniform spaces*. American Mathematical Society, Providence, R.I., 1964.
- [123] David Asaf IV and Steve Gadbois. Definition of chaos. *Amer. Math. Monthly*, 99:865, 1992.
- [124] I.M. James. *General topology and homotopy theory*. Springer-Verlag, New York, 1984.
- [125] I.M. James. *Handbook of algebraic topology*. Elsevier, Amsterdam; New York, 1995.
- [126] I.M. James. *History of topology*. Elsevier, Amsterdam; New York, 1999.
- [127] I.M. James. *Topologies and uniformities*. Springer, London; New York, 1999.
- [128] Arthur Jones, Sidney A. Morris, and Kenneth R. Pearson. *Abstract algebra and famous impossibilities*. Springer-Verlag Publishers, New York, Berlin etc, 1991 & 1993.

- [129] V. Kannan. *Ordinal invariants in topology*. American mathematical society, Providence, R.I., 1981.
- [130] Christian Kassel. *Quantum groups*. Springer-Verlag, New York, 1995.
- [131] Louis H. Kauffman and Randy A. Baadhio. *Quantum topology*. World Scientific Publishers, Singapore; River Edge, 1993.
- [132] John L. Kelley. *General topology*. Springer-Verlag, New York, 1991.
- [133] S.M. Khaleelulla. *Counterexamples in topological vector spaces*. Springer-Verlag, Berlin ; New York, 1982.
- [134] Wan-hui Kim and Robert Tien-wen Chien. *Topological analysis and synthesis of communication networks*. Columbia University Press, New York, 1962.
- [135] Bruce R. King. *Applications of graph theory and topology in inorganic cluster and coordination chemistry*. CRC Press, Boca Raton, Florida, 1993.
- [136] T. Yung Kong and Azriel Rosenfeld. *Topological algorithms for digital image processing*. Elsevier, Amsterdam; New York, 1996.
- [137] Gottfried Köthe. *Topological vector spaces*. Springer-Verlag, Berlin ; New York, 1983.
- [138] Kenneth Kunen. *Set theory*. North-Holland, Amsterdam, 1980.
- [139] Kenneth Kunen and Jerry E. Vaughan, editors. *Handbook of set-theoretic topology*. North-Holland, Amsterdam, 1984.
- [140] Kazimierz Kuratowski. *Introduction to set theory and topology*. Pergamonn Press, New York, 1961.
- [141] H.A. Lauwerier. *Fractals: endlessly repeated geometrical figures*. Princeton University Press, Princeton, N.J., 1991.
- [142] John M. Lee. *Introduction to topological manifolds*. Springer, New York, 2000.
- [143] John M. Lee. *Introduction to smooth manifolds*. Springer, New York, 2002.
- [144] Seymour Lipschutz. *Schaum's outline of general topology*. McGraw Hill, 1968.

- [145] Ying-ming Liu and Mao-kang Luo. *Fuzzy topology*. World Scientific Publishers, River Edge, N.J., 1997.
- [146] Charles Livingston. *Knot theory*. The Mathematical association of America, 1993.
- [147] E.N. Lorenz. Deterministic nonperiodic flow. *Journal of the Atmospheric Sciences*, 20: 130–141, 1963.
- [148] Saunders Maclane. *Categories for the working mathematician, second edition*. Springer-Verlag, New York, 1998.
- [149] Benoit B. Mandelbrot. How long is the coast of Britain? statistical self-similarity and fractional dimension. *Science*, 155:636–638, 1967.
- [150] Benoit B. Mandelbrot. *The fractal geometry of nature*. W.H. Freeman, New York, 1983.
- [151] R.D. Mauldin, editor. *The Scottish Book: Mathematics from the Scottish Café*. Birkhäuser, Boston, 1981.
- [152] Robert M. May. Biological populations with nonoverlapping generations: Stable points, stable cycles, and chaos. *Science*, 186:645–647, 1974.
- [153] George McCarty. *Topology; an introduction with application to topological groups*. McGraw Hill, New York, 1967.
- [154] Robert A. McCoy and Ibulu Ntantu. *Topological properties of spaces of continuous functions*. Springer-Verlag, New York, Berlin, 1988.
- [155] Dusa McDuff and Dietmar Salamon. *Introduction to symplectic topology*. Oxford University Press, New York, 1998.
- [156] Richard E. Merrifield and Howard E. Simmons. *Topological methods in chemistry*. Wiley, New York, 1989.
- [157] Emil G. Milewski. *The topology problem solver: a complete solution guide to any textbook*. Research and Education Association, Piscataway, N.J., 1994.
- [158] M. Mimura and Hirosi Toda. *Topology of Lie groups*. American Mathematical Society, Providence, R.I., 1991.

- [159] Edward E. Moise. *Introductory problem courses in analysis and topology*. Springer-Verlag, New York, 1982.
- [160] Mikhail I. Monastyrskaei. *Topology of gauge fields and condensed matter*. Plenum Press, New York, 1993.
- [161] Deane Montgomery and Leo Zippin. *Topological transformation groups*. Interscience Publishers, New York, 1955.
- [162] Robert L. Moore. *Foundations of point set topology*. American Mathematical Society, Providence, R.I., 1962.
- [163] Giuseppe Morandi. *The role of topology in classical and quantum physics*. Springer-Verlag, Berlin, New York, 1992.
- [164] K. Morita and J. Nagata, editors. *Topics in general topology*. North Holland, Amsterdam, 1989.
- [165] Sidney A. Morris. *Pontryagin duality and the structure of locally compact abelian groups*. Cambridge University Press, Cambridge; New York, 1977.
- [166] Sidney A. Morris. Are finite topological spaces worthy of study. *Austral. Math. Soc. Gazette*, 11:31–32, 1984.
- [167] Sidney A. Morris. An elementary proof that the Hilbert cube is compact. *Amer. Math. Monthly*, 91:563–564, 1984.
- [168] Gregory L. Naber. *Topological methods in Euclidean spaces*. Cambridge University Press, Cambridge, New York, 1980.
- [169] Gregory L. Naber. *Topology, geometry and gauge fields: foundations*. Springer, New York, 1997.
- [170] Keio Nagami. *Dimension theory*. Academic Press, New York, 1970.
- [171] Jun-iti Nagata. *Modern dimension theory*. Interscience Publishers, New York, 1965.
- [172] Jun-iti Nagata. *Modern general topology*. North Holland Publishing Company, Amsterdam, 1985.

- [173] Mikio Nakahara. *Geometry, topology and physics*. A. Hilger, Bristol, England; New York, 1990.
- [174] H. Nakano. *Topology and linear topological spaces*. Maruzen Co., Tokyo, 1951.
- [175] Lawrence Narici and Edward Beckenstein. *Topological vector spaces*. M. Dekker, New York, 1985.
- [176] Charles Nash. *Topology and geometry for physicists*. Academic Press, London, New York, 1983.
- [177] M.H.A. Newman. *Elements of the topology of plane sets of points*. Greenwood Press, Westport, Conn., 1985.
- [178] A.L. Onishchik. *Topology of transitive transformation groups*. Johann Ambrosius Barth, Leipzig, 1994.
- [179] John C. Oxtoby. *Measure and category; a survey of the analogies between topological and measure spaces*. Springer-Verlag, New York, 1971.
- [180] A.R. Pears. *Dimension Theory of general spaces*. Cambridge University Press, Cambridge, New York, 1975.
- [181] Anthony L. Peressini. *Ordered topological vector spaces*. Harper and Row, New York, 1967.
- [182] C.G.C. Pitts. *Introduction to metric spaces*. Oliver and Boyd, Edinburgh, 1972.
- [183] Henri Poincarè. *Science and method; translated and republished*. Dover Press, New York, 2003.
- [184] Ian R. Porteous. *Topological geometry*. Cambridge University Press, Cambridge, England, New York, 1981.
- [185] Bodo von Querenburg. *Mengentheoretische Topologie*. Springer-Verlag, Berlin, 2001.
- [186] George M. Reed. *Surveys in general topology*. Academic Press, New York, 1980.
- [187] G.M. Reed, A.W. Roscoe, and R.F. wachter. *Topology and category theory in computer science*. Oxford University Press, Oxford, England, 1991.

- [188] Renzo L. Ricca. *An introduction to the geometry and topology of fluid flows*. Kluwer Academic Publishers, Dordrecht; Boston, 2001.
- [189] A.P. Robertson and Wendy Robertson. *Topological vector spaces*. Cambridge University Press, Cambridge, England, 1973.
- [190] Joseph J. Rotman. *An introduction to algebraic topology*. Springer-Verlag, New York, 1988.
- [191] Mary Ellen Rudin. *Lectures on set theoretic topology*. American Mathematical Society, Providence, R.I., 1975.
- [192] Hans Sagan. *Space-filling curves*. Springer-Verlag, New York, 1994.
- [193] A.N. Sarkovskii. Coexistence of cycles of a continuous map of a line into itself. *Ukrainian Mat. Z.*, 16:61–71, 1964.
- [194] Saharon Shelah. On a problem of Kurosh, Jonsson groups, and applications. *Word problems II, Stud. Logic Found. Math.*, 995:373–394, 1980.
- [195] M. Signore and F. Melchiorri. *Topological defects in cosmology*. World Scientific Publishers, Singapore, 1998.
- [196] George E. Simmons. *Introduction to topology and modern analysis*. McGraw Hill, New York, 1963.
- [197] I.M. Singer. *Lecture notes on elementary topology and geometry*. Springer-Verlag, New York, 1967.
- [198] Christopher G. Small. *The statistical theory of shape*. Springer, New York, 1996.
- [199] Alexei Sossinsky. *Knots: mathematics with a twist*. Harvard University Press, 2002.
- [200] Edwin H. Spanier. *Algebraic topology*. Springer-Verlag, New York, 1966.
- [201] John R. Stallings. *Lectures on polyhedral topology*. Tata Institute of Fundamental research, Bombay, India, 1967.
- [202] Lynn Arthur Steen and J. Arthur Seebach Jr. *Counterexamples in topology*. Holt, Rinehart and Winston, New York, 1970.

- [203] N.E. Steenrod. *Reviews of papers in algebraic and differential topology, topological groups and homological algebra*. American Mathematical Society, Providence, R.I., 191968.
- [204] N.E. Steenrod. *The topology of fibre bundles*. Princeton University Press, Princeton, N.J., 1951.
- [205] John Stillwell. *Classical topology and combinatorial group topology*. Springer-Verlag, New York, 1995.
- [206] *The MacTutor History of Mathematics Archive*.
<http://www-gap.dcs.st-and.ac.uk/history/>, 2001–.
- [207] Wolfgang Thron. *Topological structures*. Holt, Rinehart and Winston, New York, 1966.
- [208] *Topology*. <http://www.elsevier.com/locate/top>, 1962–. A hard-copy refereed research journal in topology and geometry.
- [209] *Topology and its Applications*. <http://www.elsevier.nl/locate/topol>, 1971–. A hard-copy refereed research journal in topology.
- [210] *Topology Atlas*. <http://at.yorku.ca/topology>, 1995–. Topology related resources.
- [211] *Topology Proceedings*.
<http://topology.auburn.edu/tp/top2.htm>, 1977–. A hard-copy refereed research journal.
- [212] J. van Mill. *The infinite-dimensional topology of function spaces*. Elsevier, Amsterdam, New York, 2001.
- [213] Jan van Mill and George M. Reed. *Open problems in topology*. North-Holland, Amsterdam, 1990.
- [214] Michel Vellekoop and Raoul Berglund. On intervals, transitivity = chaos. *Amer. Math. Monthly*, 101:353–355, 1994.
- [215] Steven Vickers. *Topology via logic*. Cambridge University Press, Cambridge, 1990.
- [216] A.V. Vologodskii. *Topology and physics of circular DNA*. CRC Press, Boca Raton, 1992.
- [217] Russell C. Walker. *The Stone-Cech compactification*. Springer-Verlag, Berlin; New York, 1974.

- [218] C.T.C. Wall. *A geometric introduction to topology*. Addison-Wesley, Reading, Mass., 1972.
- [219] A.D. Wallace. *Differential topology; first steps*. W.A. Benjamin, New York, 1968.
- [220] Evert Wattel. *The compactness operator in set theory and topology*. Mathematisch Centrum, Amsterdam, 1968.
- [221] Jeffrey R. Weeks. *The shape of space*. Marcel Dekker, New York, 2002.
- [222] Stuart G. Whittington, De Witt Sumners, and Timothy Lodge, editors. *Topology and geometry in polymer science*. Springer, New York, 1998.
- [223] R.L. Wilder. *Topology of manifolds*. Amer. Math. Soc. Colloquium Publ., RI, USA, vol. 32, 1979.
- [224] Robin Wilson. *Four colors suffice: how the map problem was solved*. Princeton University Press, Princeton, N.J., 2003.
- [225] James Yorke and T-Y. Li. Period three implies chaos. *Amer. Math. Monthly*, 82:985–992, 1975.

Index

- $GL(n, \mathbb{C})$, 320
- $O(n)$, 320
- $SL(n, \mathbb{C})$, 320
- T_1 -space, **199, 322**
- T_3 -space, **232, 233, 236**
- T_4 -space, **230, 232, 233**
- $T_{3\frac{1}{2}}$ -space, **227, 228–230, 232, 240, 242**
- $T_{3\frac{1}{2}}$, 235
- $T_{3\frac{1}{2}}$ -space, 236, 237, 239
- $U(n)$, 320
- $[0, 1]$, 217, 218, 227, 228, 237, 238, 240, 245
- \mathbb{Q} , 219
- \mathbb{R} , 219
- $\mathbb{Z} >$, 219
- ε -covering, **307**
- k_ω -space, **236**
- n -cube, **191**
- s -dimensional outer measure
 - Hausdorff, **308**
- \aleph_0 , **249**
- abelain, 331
- abelian group
 - torsion-free, **337**
- accumulation point, **57**
- Acta Arithmetica, 276
- algebraic number, **253**
- analytic
 - set, 274
- analytic set, **131**
- antisymmetric binary relation, 219
- arrow, 90
- attracting fixed point, **281**
- attracting periodic point, **290**
- axiom
 - least upper bound, **66**
- Axiom of Choice, 222
- Baire Category Theorem, **140, 141**
- Baire Category Theorem for Locally Compact Spaces, **339**
- Baire space, **141**
- Baire, René Louis, **270**
- ball
 - closed unit, 160
- Banach
 - Fixed Point Theorem, **138**
- Banach space, **134, 330**
- Banach, Stefan, **270**
- Banach-Tarski paradox, 271
- Banachiewicz, Tadeusz, 274
- basis, **42**
- Besicovitch
 - Abram Samoilovitch, 306
- bifurcation, **290**
 - period doubling, 291

- Bifurcation Theorem
 - First, **290**
- bijection, **248**
- bijective, **28**
- bikompakt, 161
- binary relation
 - antisymmetric, 219
 - reflexive, 77, 219
 - symmetric, 77
 - transitive, 77, 219
- Birkhoff
 - George David, 299
- Bolzano-Weierstrass Theorem, **128**
- bound
 - greatest lower, 66
 - lower, **66**
 - upper, 66, **221**, 222
- bounded, **66**, 156
 - above, **66**
 - below, **66**
 - metric, 114
 - metric space, 114
 - set, 136
- box topology, **186**
- Brouwer Fixed Point Theorem, 100
- Brouwer, Luitzen Egbertus Jan, **271**
- butterfly effect, 298
- $C[0, 1]$, 53, 160
- \mathfrak{c} , 261
- c_0 , 116
- Café, Scottish, 271
- Cantor
 - Georg, 256
- Cantor set, **183**
- Cantor Space
 - middle two-thirds, **206**
- Cantor space, **183**
- Cantor, Georg, 274
- card , **261**
- cardinal number, **261**
- cardinality, **249**
- carpet
 - Sierpiński, 275
- cartesian product, **214**, 237
- category
 - first, **142**
 - second, **142**
- Cauchy sequence, **125**
- Cauchy-Riemann
 - manifold, 120
- centre, 331
- chaos, 293, 306
- chaotic dynamical system, **300**
- clopen
 - set, **24**
- closed
 - mapping, 159, **167**
 - set, **22**
 - unit ball, 160
- closure, **59**
- cluster point, **57**
- coarser topology, 97, **167**
- coarsest topology, 215
- cofinite topology, **26**
- collectionwise Hausdorff, **204**

- commutator subgroup, 331, **338**
- compact, **150**, **151**, 218, 224, 226, 227, 230, 232, 234, 236, 239
 - space, **151**
- compactification
 - Stone-Čech, **239**, 242–245
- compactly generated, **327**
- compactum, 177
- comparable
 - `textbf`, 221
- complete, **126**
- completely metrizable, **130**
- completely regular, **227**, 229, 237
- completely regular space, 228
- completion
 - of a metric space, **132**
- component, 101, **175**, 176, 328, 331
- Compositio Mathematica, 273, 276
- conjugate dynamical systems, **302**
- conjugate map, **302**
- connected, **67**, 235, 237, 238
 - component, **175**
 - locally, **178**, **209**
 - manifold, 120
 - path, **98**
 - pathwise, **98**
- connected topological group, 327
- continuous, 90
 - at a point, 146
 - homomorphism, **325**
- continuous homomorphism, **325**
- continuous mapping, **92**
- continuum, **176**
- contraction
 - mapping, **137**
- Contraction Mapping Theorem, **138**
- contradiction, 38
- converge, 121
- Converse of Heine-Borel Theorem, **156**
- convex
 - set, **143**
- countability
 - first axiom of, 117
 - second axiom of, 47
- countable
 - second, **201**
- countable bases, **117**
- countable chain condition, **203**
- countable closed topology, 32
- countable set, 249
- countably infinite, **249**
- covering
 - open, **151**
- CR-manifold, 120
- cube, 227, **227**, 229, 230, 232, 237
 - n , **191**
 - Hilbert, **191**, 217, 218, 227, 233, 235, 236
- curve
 - Sierpiński, 275
 - space-filling, 275
- cycle
 - m , **290**
- cylinder, 174
- decreasing sequence, **127**
- dense, **60**

- everywhere, **60**
- nowhere, **140**
- denumerable, **249**
- Devaney
 - Robert L., 299
- diagonal, 165
- diam, **307**
- diameter, **307**
- Dickstein, Samuel, 275
- differentiable, **139**
 - manifold, 120
- \dim_H , **309**
- dimension
 - Hausdorff, **309**
 - zero, 102
- direct product
 - restricted, **332**
 - weak, **332**
- disconnected, **68**, 98
 - totally, 101, **329**, 331
- discrete
 - metric, **105**
 - space, **15**
 - topology, **15**
- distance, **104**
- distance between sets, 125
- divisible group, **334**
- doubling function, **283**
- dyadic, 231
- dynamical system, 281, **299**
 - chaotic, **300**
- dynamical systems
 - conjugate, **302**
- ecology, 284
- Egorov, Dimitri Feddrovich, 274
- element
 - greatest, **66**
 - least, **66**
- embedded, **216**, 230, 232, 233, 236
- embedding
 - isometric, **132**
- Embedding Lemma, 198, 216, 227, 229
- empty union, 19
- equipotent, **248**
- equivalence relation, 89, 133, 248
- equivalent metric, **112**
- ergodic theory, 299
- euclidean
 - locally, 120
- euclidean metric, **105**
- euclidean metric on \mathbb{R}^2 , 105
- euclidean topology, **36**
- euclidean topology on \mathbb{R}^n , 45
- evaluation map, **198**, **216**, 229, 240, 242
- eventually fixed, **279**
- eventually periodic, **280**
- everywhere dense, **60**
- extremally disconnected space, **204**
- F_σ -set, 40, 146
- f^{-1} , **29**
- final segment topology, 20
- finer topology, 97, **167**
- finite, **249**
- finite intersection property, 224, **224**, 225, 226
- finite subcovering, **151**

- finite-closed topology, **26**
- first axiom of countability, 117, **237**
- First Bifurcation Theorem, **290**
- first category, **142**
- first countable, 117, **237**
- fixed point, 100, **137, 278**
 - attracting, **281**
 - eventually, 279
 - neutral, **282**
 - repelling, **281**
- fixed point property, 100
- Fixed Point Theorem, 100
 - Banach, **138**
- Fréchet, Maurice, **273**
- fractal, 275
 - geometry, 306
- Freyd Adjoint Functor Theorem, 239
- function
 - bijjective, **28**
 - continuous, 90
 - doubling, **283**
 - injective, **28**
 - inverse, **28**
 - logistic, **284**
 - one-to-one, **28**
 - onto, **28**
 - surjective, **28**
 - tent, **304**
- Fundamenta Mathematica, 274
- Fundamental Theorem of Algebra, **178**
- G_δ -set, 40, 146
- general linear group, **320**
- Generalized Heine-Borel Theorem, 157, **173**
- Georg Cantor, 256
- graphical analysis, **284**
- greatest element, **66**, 221, **221**, 223
- greatest lower bound, 66
- group
 - divisible, **334**
 - general linear, **320**
 - LCA, **328**
 - linear, **320**
 - orthogonal, 320
 - quotient, 328, 330
 - special linear, **320**
 - special orthogonal, **320**
 - special unitary, **320**
 - topological, **319**
 - topology, **321**
 - torsion-free, **337**
 - unitary, **320**
- group of homeomorphisms, 81
- group topology, **321**
- Hausdorff
 - s -dimensional outer measure, **308**
 - collectionwise, **204**
 - dimension, **309**
 - Felix, 306
- Hausdorff space, 74, **113**, 165, 235, 238, 322
- Hausdorff topological group, 332
- Hausdorff, Felix, **273**
- Hausdorff-Besicovitch measure, 306
- Heine-Borel Theorem, **156**
 - Converse, **156**

- Generalized, 157
- Hilbert cube, **191**, 217, 218, 227, 233, 235, 236
- Hilbert, David, 271
- homeomorphic, **75**
 - locally, 88
- homeomorphism, **75**
 - local, 88
- homogeneous, **322**
- homomorphism
 - continuous, **325**
- identity component, 328
- if and only if, 41
- image
 - inverse, **29**
- increasing sequence, **127**
- indiscrete
 - space, **15**
 - topology, **15**
- induced topological space, 111
- induced topology, **70**, 111
- inf, 66
- infimum, 66
- infinite, **249**
 - countably, **249**
- initial segment topology, 20
- injective, **28**
- injective limit, **339**
- Int, 65, **140**
- interior, 65, **140**, 331
- Intermediate Value Theorem, **99**
- intersection of topologies, 33
- interval, **84**
- inverse
 - function, **28**
 - image, **29**
- inverse mapping system, **339**
- isolated point, **146**, **185**
- isometric, 117, **132**
 - embedding, **132**
- isometry, 117, **132**
- isomorphic
 - topologically, **325**
- isomorphism
 - topological, **325**
 - topological group, **325**
- iterate, **277**
- l_1 , 116
- l_2 , 116
- l_∞ , 116
- LCA-group, **328**
- least element, **66**
- Least Upper Bound Axiom, **66**
- Lebesgue measure, 299, 306, 332
- Lemma
 - Embedding, 198, 227, 229
 - Zorn's, 222, **222**, 223, 225
- limit
 - injective, **339**
 - projective, **339**
- limit point, **57**
- Lindelöf space, **235**, 236
- Lindelöf's Theorem, 202
- Lindenbaum, Adolph, 275
- line

- Sorgenfrey, 66, 153, 166
- linear group, **320**
- linear order, **221**
- linear transformation, 330
- linearly independent, 223
- linearly ordered set, 221–223, 225
- local
 - homeomorphism, 88
- locally
 - compact, 174
 - connected, **178**
 - euclidean, 120
 - homeomorphic, 88
- locally compact subgroup, 326, 331
- locally connected, **209**, 238
- logistic function, **284**
- lower bound, 66
- lower semicontinuous, 147
- Luzin, Nikolai Nikolaevich, 274

- Mandelbrot
 - Benoit, 306
- manifold
 - Cauchy-Riemann, 120
 - connected, 120
 - CR-, 120
 - differentiable, 120
 - Riemannian, 120
 - smooth, 120
 - topological, 120
 - topological with boundary, 120
- map
 - bijjective, **28**
 - conjugate, **302**
 - evaluation, **198**
 - injective, **28**
 - inverse, **28**
 - one-to-one, **28**
 - onto, **28**
 - quadratic, **289**
 - surjective, **28**
- mapping
 - closed, 159, **167**
 - continuous, **92**
 - contraction, **137**
 - evaluation, 216, 229, 240, 242
 - lower semicontinuous, 147
 - open, 145, 159, **167**, 328
 - upper semicontinuous, 147
- market
 - stock, 281
- mathematical proof, 14
- matrix
 - orthogonal, **320**
 - unitary, **320**
- maximal, 221, **221**, 222, 223, 225, 226
- May
 - Robert L., 298
- Mazurkiewicz, Stefan, 274
- meager, **142**
- Mean Value Theorem, **139**
- measure
 - Hausdorff-Besicovitch, 306
 - Lebesgue, 306, 332
- metric, **104**
 - bounded, 114

- discrete, **105**
- equivalent, **112**
- euclidean, **105, 105**
- Post Office, **204**
- space, **104**
- metric space, **235**
 - bounded, **114**
 - complete, **126**
 - totally bounded, **119**
- metrizable, **114**
 - completely, **130**
- metrizable space, **217, 218, 236**
- monotonic sequence, **127**
- Morse
 - Harold Calvin Marston, **299**
- \mathbb{N} , **72**
- \mathbb{N} , **15**
- n -sphere, **173**
- natural numbers
 - Sarkovskii's ordering, **293**
- neighbourhood
 - symmetric, **322**
- neighbourhood, **62**
- neutral fixed point, **282**
- non-discrete Hausdorff group topology, **336**
- norm, **108**
- normal space, **117, 160, 230, 231–238**
- normal subgroup, **331**
- normed vector space, **108**
- nowhere dense, **140**
- number
 - algebraic, **253**
 - cardinal, **261**
 - transcendental, **253**
- object, **90**
- one-to-one, **28**
- one-to-one correspondence, **248**
- onto, **28**
- open
 - ball, **109**
 - covering, **151**
 - mapping, **145, 159, 167**
 - set, **21**
- open covering, **151**
- open mapping, **328**
- Open Mapping Theorem, **144**
- Open Mapping Theorem for Locally Compact
 - Groups, **340**
- open subgroup, **326**
- orbit, **277**
- order
 - linear, **221**
 - partial, **219**
- order diagram, **220, 221, 223**
- ordering
 - Sarkovskii's, **293**
- orthogonal
 - matrix, **320**
- orthogonal group, **320**
 - special, **320**
- \mathbb{P} , **40, 72**
- $\mathcal{P}(S)$, **256**
- paradox
 - Banach-Tarski, **271**

- partial order, 219, **219**, 223, 225
- partially ordered set, 219, **219**, 221–223
- path, **98**
- path-connected, **98**
- pathwise connected, **98**
- peak point, **127**
- perfect space, **185**
- period doubling bifurcation, 291
- Period Three Theorem, **293**
- periodic, **279**
 - eventually, **280**
- periodic point
 - attracting, **290**
 - repelling, **290**
- phase portrait, **281**
- Poincarè
 - Jules Henri, 298
- point, 57
 - accumulation, **57**
 - attracting fixed, **281**
 - attracting periodic, **290**
 - cluster, **57**
 - fixed, 100, **137**
 - isolated, **146**, **185**
 - limit, **57**
 - neighbourhood of, **62**
 - neutral fixed, **282**
 - peak, **127**
 - repelling fixed, **281**
 - repelling periodic, **290**
- Polish space, **131**
- population growth, 281, 284
- portrait
 - phase, **281**
- Post Office metric, **204**
- power set, **256**
- prime period, **279**
- Principle of the Excluded Middle, 272
- product, **163**, **185**, **214**, 237
 - cartesian, **214**
 - restricted direct, **332**
 - semidirect, **342**
 - space, **163**, **214**, 215
 - topology, **163**, 169, **214**
 - weak direct, **332**
- product of cardinal numbers, **266**
- product space, **185**, 227, 235
- product topology, 47, **185**, 214
- projective limit, **339**
- projective mapping system, **339**
- proof
 - by contradiction, 38
 - if and only if, 41
 - mathematical, 14
- proper subset, 25
- property
 - fixed point, 100
 - separation, 34
 - topological, 89
- \mathbb{Q} , 39, **72**
- quadratic map, **289**
- quotient group, 328, 330
- quotient maps not always closed, 329
- quotient topology, 328
- \mathbb{R} , 20, **36**

- \mathbb{R}^2 , 45
- \mathbb{R}^n , 45
- reflexive, 77
- reflexive binary relation, 77, 219
- regular, 166
 - completely, **227**
 - space, 74
- regular space, **232**, 233–235, 237
- relation
 - equivalence, 89, 133, 248
- relative topology, **70**
- Rendiconti dei Circolo Matimatico di Palermo, 276
- repelling fixed point, **281**
- repelling periodic point, **290**
- restricted direct product, **332**
- Riemannian
 - manifold, 120
- Rotkiewicz, Andrzej, 276
- Royal Society, 298
- Russell, Bertram, 271
- Ruziewicz, Stanislaw, 275

- \mathbb{S}^n , 173
- \mathbb{S}^1 , 173
- Saks, Stanislaw, 275
- Sarkovskii's ordering, **293**
- Sarkovskii's Theorem, **294**
 - converse, **294**
- scattered space, **204**
- Schauder, Juliusz Pawel, 275
- second axiom of countability, 47, 166, **201**
- second category, **142**
- second countable, **201**, 233, 235, 236
- seed, **277**
- semicontinuous
 - lower, 147
 - upper, 147
- semidirect product, **342**
- sensitively on initial conditions, **300**
- sensitivity, **300**
- separable, 64, **131**, 166, **196**
- separable space, 217, 218, 235, 236, 238
- separates points, **198**, 216
- separates points and closed sets, **198**, 216
- separation property, 34
- sequence
 - Cauchy, **125**
 - convergent, 121
 - decreasing, **127**
 - increasing, **127**
 - monotonic, **127**
- set
 - F_σ , 40, 146
 - G_δ , 40, 146
 - analytic, **131**, 274
 - bounded, 136
 - Cantor, **183**
 - clopen, **24**
 - closed, **22**
 - convex, **143**
 - countable, **249**
 - denumerable, **249**
 - finite, **249**
 - first category, **142**
 - infinite, **249**

- linearly ordered, 221–223, 225
- meager, **142**
- of continuous real-valued functions, 53
- of integers, 39, **72**
- of irrational numbers, 40, **72**
- of natural numbers, 15, **72**
- of positive integers, 15, **72**
- of rational numbers, 39, **72**
- of real numbers, 20
- open, **21**
- partially ordered, 219, **219**, 221–223
- power, **256**
- second category, **142**
- uncountable, **249**
- Sierpinski space, 32
- Sierpiński
 - carpet, 275
 - curve, 275
 - triangle, 275
- Sierpiński, Waclaw, **274**
- Smith
 - P.A., 299
- smooth
 - manifold, 120
- Sorgenfrey line, 66, 153, 235, 238
- Souslin space, **131**
- space
 - T_0 , 32
 - T_1 , 32, 166, **199**, **322**
 - T_2 , 74, **113**
 - T_3 , 74, **232**, 233, 236
 - T_4 , 117, **230**, 232, 233
 - $T_{3\frac{1}{2}}$, 228–230, 232, 240, 242
 - $T_{3\frac{1}{2}}$, 235–237, 239
 - $T_{3\frac{1}{2}}$, **227**
 - k_ω , 236
 - Baire, **141**
 - Banach, **134**, 330
 - bikompakt, 161
 - Cantor, **183**
 - collectionwise Hausdorff, 204
 - compact, **151**, 218, 224, 226, 227, 230, 232, 234, 236, 239
 - complete metric, **126**
 - completely metrizable, **130**
 - completely regular, 227–229, 237
 - connected, **67**, 235, 237, 238
 - disconnected, **68**
 - discrete, **15**
 - extremally disconnected, **204**
 - first countable, **237**
 - Hausdorff, 74, **113**, 165, 235, 238, 322
 - homogeneous, **322**
 - indiscrete, **15**
 - induced by a metric, 111
 - Lindelöf, **235**, 236
 - locally compact, 174
 - locally connected, **178**, **209**, 238
 - metric, **104**, 235
 - metrizable, **114**, 217, 218, 236
 - normal, 117, 160, 230–238
 - normed vector, 108
 - perfect, **185**
 - Polish, **131**
 - product, **163**, **185**, **214**, 215, 227, 235
 - regular, 74, 166, **232**, 233–235, 237

- scattered, **204**
- second countable, **201**, 233, 235, 236
- separable, 64, **131**, 166, **196**, 217, 218, 235, 236, 238
- Sierpinski, 32
- Souslin, **131**
- topological, **14**
- totally disconnected, 101, 166
- Tychonoff, **227**, 228–230, 232, 235, 237, 239, 240, 242
- space-filling curve, 275
- space; compact, 239
- special
 - orthogonal group, **320**
 - unitary group, **320**
- special linear group, **320**
- Steinhaus, Hugo Dyonizy, 271
- stock market, 281
- Stone-Čech Compactification, 239, 242–245
- Studia Mathematica, 271
- subbasis, 54
- subcovering
 - finite, **151**
- subgroup
 - commutator, 331, **338**
 - locally compact, 326, 331
 - normal, 331
 - open, 326
- subgroup topology, **324**
- subsequence, **127**
- subset
 - dense, **60**
 - everywhere dense, **60**
 - proper, 25
- subspace, **70**
- subspace topology, **70**
- sum of cardinal numbers, **264**
- sup, 66
- suppose
 - proof by contradiction, 38
- supremum, 66
- surface, 174
- surjective, **28**
- symmetric binary relation, 77
- symmetric neighbourhood, 322
- system
 - dynamical, **299**
- systems
 - conjugate dynamical, **302**
- T_0 -space, 32
- T_1 -space, 32, 166
- T_2 -space, 74, **113**
- T_3 -space, 74
- T_4 -space, 117
- \mathbb{T} , 120
- Tarski, Alfred, 270
- tent function, **304**
- Theorem
 - Baire Category, **140**, 141
 - Baire Category for Locally Compact Spaces, 339
 - Banach Fixed Point, **138**
 - Bolzano-Weierstrass, **128**
 - Brouwer Fixed Point, 100
 - Contraction Mapping, **138**

- Converse of Heine-Borel, **156**
- Converse of Sarkovskii's, 294
- First Bifurcation, 290
- Freyd Adjoint Functor, 239
- Fundamental Theorem of Algebra, **178**
- Generalized Heine-Borel, 157, **173**
- Heine-Borel, **156**
- Lindelöf's, 202
- Mean Value, 139
- Open Mapping, **144**
- Open Mapping for Locally Compact Groups, **340**
- Sarkovskii's, **294**
- The Period Three, 293
- Tychonoff, **172**, 213, 218, **226**
- Tychonoff's, 224
- Urysohn and its Converse, 202
- Urysohn Metrization, 234
- Urysohn's, 200, 235
- Weierstrass Intermediate Value, **99**
- Well-Ordering, 222
- topological
 - manifold, 120
 - manifold with boundary, 120
- topological group, 237, **319**
 - compactly generated, **327**
 - connected, 327
 - Hausdorff, 332
 - isomorphism, **325**
 - topology, **321**
- topological group isomorphism, **325**
- topological isomorphism, **325**
- topological property, 89
- topological space, **14**
- topologically isomorphic, 325
- topologically transitive, **302**
- topology, **14**
 - box, **186**
 - coarser, 97, **167**
 - coarsest, 215
 - cofinite, **26**
 - countable closed, 32
 - discrete, **15**
 - euclidean, **36**
 - euclidean on \mathbb{R}^n , 45
 - final segment, 20
 - finer, 97, **167**
 - finite-closed, **26**
 - indiscrete, **15**
 - induced, **70**
 - induced by a metric, 111
 - initial segment, 20
 - intersection, 33
 - product, 47, **163**, 169, **185**, 214, **214**
 - quotient, 328
 - relative, **70**
 - subgroup, **324**
 - subspace, **70**
 - topological group, **321**
 - Tychonoff, **214**
 - usual, 72
- torsion-free, **337**
- totally bounded
 - metric space, **119**
- totally disconnected, 101, 166, **329**, 331
- totally disconnected normal subgroup, 331

- transcendental number, **253**
- transformation
 - linear, 330
- transitive, **300**
 - topologically, **302**
- transitive binary relation, 77, 219
- triangle
 - Sierpiński, 275
- Tychonoff
 - topology, **214**
- Tychonoff space, **227**, 228–230, 232, 235, 237, 239, 240, 242
- Tychonoff's Theorem, **172**, 213, 218, 224, **226**
- Ulam, Stanislaw, 271
- uncountable set, **249**
- union
 - empty, 19
- unit ball, 160
- unitary
 - matrix, **320**
- unitary group, **320**
 - special, **320**
- upper bound, 66, **221**, 222, 223, 225
- upper semicontinuous, 147
- Urysohn's Lemma, 238
- Urysohn's Metrization Theorem, 234
- Urysohn's Theorem, 200, 235
- Urysohn's Theorem and its Converse, 202
- usual topology, 72
- van der Waerden, Bartel Leendert, 272
- vector space
 - normed, 108
- weak direct product, **332**
- weather, 281
- Weierstrass Intermediate Value Theorem, **99**
- Well-Ordering Theorem, 222
- \mathbb{Z} , 39, **72**
- 0-dimensional, 102
- Zaremba, Stanislaw, 275
- Zentralblatt für Mathematik, 276
- zero-dimensional, 102
- Zorn's Lemma, 218, 222, **222**, 223, 225



EMS Tracts in Mathematics, Vol. 2

Karl H. Hofmann, Sidney A. Morris

**The Lie Theory of Connected Pro-Lie Groups
A Structure Theory for Pro-Lie Algebras,
and Connected Locally Compact Groups**

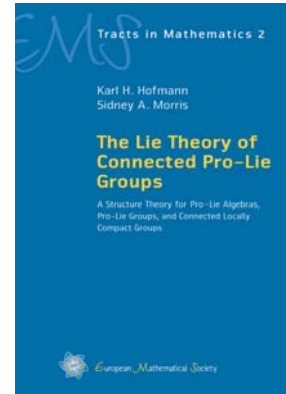

2007. 17 x 24 cm. 693 pages.

Hardcover € 88.00

For the Americas: US\$ 118.00

ISBN 978-3-03719-032-6

Lie groups were introduced in 1870 by the Norwegian mathematician Sophus Lie. A century later Jean Dieudonné quipped that Lie groups had moved to the center of mathematics and that one cannot undertake anything without them.

If a complete topological group G can be approximated by Lie groups in the sense that every identity neighborhood U of G contains a normal subgroup N such that G/N is a Lie group, then it is called a *pro-Lie group*. Every locally compact connected topological group and every compact group is a pro-Lie group. While the class of locally compact groups is not closed under the formation of arbitrary products, the class of pro-Lie groups is.

For half a century, locally compact pro-Lie groups have drifted through the literature, yet this is the first book which systematically treats the Lie and structure theory of pro-Lie groups irrespective of local compactness. This study fits very well into that current trend which addresses infinite dimensional Lie groups. The results of this text are based on a theory of pro-Lie algebras which parallels the structure theory of finite dimensional real Lie algebras to an astonishing degree even though it has to overcome greater technical obstacles.

This book exposes a Lie theory of connected pro-Lie groups (and hence of connected locally compact groups) and illuminates the manifold ways in which their structure theory reduces to that of compact groups on the one hand and of finite dimensional Lie groups on the other. It is a continuation of the authors' fundamental monograph on the structure of compact groups (1998, 2006), and is an invaluable tool for researchers in topological groups, Lie theory, harmonic analysis and representation theory. It is written to be accessible to advanced graduate students wishing to study this fascinating and important area of current research, which has so many fruitful interactions with other fields of mathematics.

Contents:

Panoramic Overview · Limits of Topological Groups · Lie Groups and the Lie Theory of Topological Groups · Pro-Lie Groups · Quotients of Pro-Lie Groups · Abelian Pro-Lie Groups · Lie's Third Fundamental Theorem · Profinite-Dimensional Modules and Lie Algebras · The Structure of Simply Connected Pro-Lie Groups · Analytic Subgroups and the Lie Theory of Pro-Lie Groups · The Global Structure of Connected Pro-Lie Groups · Splitting Theorems for Pro-Lie Groups · Compact Subgroups of Pro-Lie Groups · Iwasawa's Local Splitting Theorem · Catalog of Examples · Appendix 1: The Campbell–Hausdorff Formalism · Appendix 2: Weakly Complete Topological Vector Spaces · Appendix 3: Various Pieces of Information on Semisimple Lie Algebras

Bibliography · List of Symbols · Index

[Order](#)

[Order for the Americas](#)